

# Xerox® B225/B235 Multifunction Printer Quick Reference Guide



## Copy

### Making Copies

1. Load an original document into the ADF tray or on the scanner glass.

 **Note:** To avoid a cropped image, make sure that the original document and the output have the same paper size.



2. From the control panel, navigate to:

 > **Copy** > specify the number of copies

For non-touch-screen printer models, press  to navigate through the settings.

If necessary, adjust the settings.

3. Copy the document.

 **Note:** To make a quick copy, from the control panel, press .

### Copying on Both Sides of the Paper

1. Load an original document into the ADF tray or on the scanner glass.

2. From the control panel, navigate to:

 > **Copy** > **Sides**

For non-touch-screen printer models, press  to navigate through the settings.

3. Adjust the setting.
4. Copy the document.

### Copying multiple pages onto a single sheet

1. Load an original document into the ADF tray or on the scanner glass.

2. From the control panel, navigate to:

 > **Copy** > **Pages per Side**

For non-touch-screen printer models, press  to navigate through the settings.

3. Adjust the settings.
4. Copy the document.

## Email

### Configuring the Email SMTP Settings

Configure the Simple Mail Transfer Protocol (SMTP) settings to send a scanned document through e-mail. The settings vary with each service provider. For more information, refer to [Email Service Providers](#).

Before you begin, make sure that the printer is connected to a network and that the network is connected to the Internet.

### Using the Email Setup Wizard in the Printer

- Before using the wizard, make sure that the printer firmware is updated. For more information, see [Updating Firmware](#).
- For non-touch-screen printer models, press **OK** to navigate through the settings.

1. From the home screen, touch **E-mail**.
2. Touch **Set up now**, and then type your e-mail address.

3. Type the password.

- Depending on your e-mail service provider, type your account password, app password, or authentication password. For more information on the password, refer to [Email Service Providers](#), and then look for Device Password.
- If your provider is not listed, then contact your provider and ask for the Primary SMTP Gateway, Primary SMTP Gateway Port, Use SSL/TLS, and SMTP Server Authentication settings.

4. Touch **OK**.

### Using the Settings Menu in the Printer

1. From the home screen, touch **Settings** > **E-mail** > **E-mail Setup**.

2. Configure the settings.

- For more information on the password, refer to [Email Service Providers](#).
- For e-mail service providers that are not on the list, contact your provider and ask for the settings.
- For non-touch-screen printer models, press **OK** to navigate through the settings.

### Using the Embedded Web Server

1. Open a web browser, and then type the printer IP address in the address field.
  - a. To view the printer IP address, go to the printer home screen. The IP address appears as four sets of numbers separated by periods, such as 123.123.123.123.
  - b. If you are using a proxy server, then temporarily disable it to load the web page correctly.
2. Click **Settings** > **E-mail**.
3. From the E-mail Setup section, configure the settings.
4. Click **Save**.
  - a. For more information on the password, refer to [Email Service Providers](#).
  - b. For e-mail service providers that are not on the list, contact your provider and ask for the settings.

### Email Service Providers

To determine the SMTP settings of your email service provider, use the following tables.

## Gmail™



**Note:** Make sure that two-step verification is enabled on your Google account.

To enable two-step verification, go to the [Google Account Security](#) page, log in to your account, then from the Signing in to Google section, click **2-Step Verification**.

Setting	Value
Primary SMTP Gateway	smtp.gmail.com
Primary SMTP Gateway Port	587
Use SSL/TLS	Required
Require Trusted Certificate	Disabled
Reply Address	Your email address
SMTP Server Authentication	Login/Plain
Device-Initiated E-mail	Use Device SMTP Credentials
Device UserID	Your email address
Device Password	App password  <b>Note:</b> To create an app password, go to the <a href="#">Google Account Security</a> page, log in to your account, and from the Signing in to Google section, click <b>App passwords</b> .

## Yahoo!® Mail

Setting	Value
Primary SMTP Gateway	smtp.mail.yahoo.com
Primary SMTP Gateway Port	587
Use SSL/TLS	Required
Require Trusted Certificate	Disabled

Setting	Value
Reply Address	Your email address
SMTP Server Authentication	Login/Plain
Device-Initiated E-mail	Use Device SMTP Credentials
Device UserID	Your email address
Device Password	App password  <b>Note:</b> To create an app password, go to the <a href="#">Yahoo Account Security</a> page, log in to your account, and then click <b>Generate app password</b>

## Outlook Live

These settings apply to outlook.com and hotmail.com email domains.

Setting	Value
Primary SMTP Gateway	smtp.office365.com
Primary SMTP Gateway Port	587
Use SSL/TLS	Required
Require Trusted Certificate	Disabled
Reply Address	Your email address
SMTP Server Authentication	Login/Plain
Device-Initiated E-mail	Use Device SMTP Credentials

Setting	Value
Device UserID	Your email address
Device Password	Account password or app password <ul style="list-style-type: none"><li>• For accounts with two-step verification disabled, use your account password.</li><li>• For accounts with two-step verification enabled, use an app password. To create an app password, go to the <a href="#">Outlook Live Account Management</a> page, then log in to your account.</li></ul>

## AOL Mail

Setting	Value
Primary SMTP Gateway	smtp.aol.com
Primary SMTP Gateway Port	587
Use SSL/TLS	Required
Require Trusted Certificate	Disabled
Reply Address	Your email address
SMTP Server Authentication	Login/Plain
Device-Initiated E-mail	Use Device SMTP Credentials
Device UserID	Your email address
Device Password	App password  <b>Note:</b> To create an app password, go to the <a href="#">AOL Account Security</a> page, log in to your account, then click <b>Generate app password</b> .

## iCloud Mail



**Note:** Make sure that the two-step verification is enabled on your account.

Setting	Value
Primary SMTP Gateway	smtp.mail.me.com
Primary SMTP Gateway Port	587
Use SSL/TLS	Required
Require Trusted Certificate	Disabled
Reply Address	Your email address
SMTP Server Authentication	Login/Plain
Device-Initiated E-mail	Use Device SMTP Credentials
Device UserID	Your email address
Device Password	App password   <b>Note:</b> To create an app password, go to the <a href="#">iCloud Account Management</a> page, log in to your account, then from the Security section, click <b>Generate Password</b> .

#### Comcast Mail

Setting	Value
Primary SMTP Gateway	smtp.comcast.net
Primary SMTP Gateway Port	587
Use SSL/TLS	Required
Require Trusted Certificate	Disabled
Reply Address	Your email address
SMTP Server Authentication	Login/Plain
Device-Initiated Email	Use Device SMTP Credentials

Setting	Value
Device UserID	Your email address
Device Password	Account password

#### Mail.com

Setting	Value
Primary SMTP Gateway	smtp.mail.com
Primary SMTP Gateway Port	587
Use SSL/TLS	Required
Require Trusted Certificate	Disabled
Reply Address	Your email address
SMTP Server Authentication	Login/Plain
Device-Initiated E-mail	Use Device SMTP Credentials
Device UserID	Your email address
Device Password	Account password

#### Zoho Mail

Setting	Value
Primary SMTP Gateway	smtp.zoho.com
Primary SMTP Gateway Port	587
Use SSL/TLS	Required
Require Trusted Certificate	Disabled
Reply Address	Your email address
SMTP Server Authentication	Login/Plain
Device-Initiated E-mail	Use Device SMTP Credentials

Setting	Value
Device UserID	Your email address
Device Password	Account password or app password <ul style="list-style-type: none"> <li>For accounts with two-step verification disabled, use your account password.</li> <li>For accounts with two-step verification enabled, use an app password. To create an app password, go to the <a href="#">Zoho Mail Account Security</a> page, log in to your account, then from the Application-Specific Passwords section, click <b>Generate New Password</b>.</li> </ul>

#### QQ Mail



**Note:** Make sure that the SMTP service is enabled on your account.

To enable the service, from the QQ Mail home page, click **Settings > Account**, then from the POP3/IMAP/SMTP/Exchange/CardDAV/CalDAV Service section, enable either **POP3/SMTP service** or **IMAP/SMTP service**.

Setting	Value
Primary SMTP Gateway	smtp.qq.com
Primary SMTP Gateway Port	587
Use SSL/TLS	Required
Require Trusted Certificate	Disabled
Reply Address	Your email address
SMTP Server Authentication	Login/Plain
Device-Initiated E-mail	Use Device SMTP Credentials

Setting	Value
Device UserID	Your email address
Device Password	Authorization code   <b>Note:</b> To generate an authorization code, from the QQ Mail home page, click <b>Settings &gt; Account</b> , then from the POP3/IMAP/SMTP/Exchange/CardDAV/CalDAV Service section, click <b>Generate authorization code</b>

#### NetEase Mail (mail.163.com)

 **Note:** Make sure that the SMTP service is enabled on your account.

To enable the service, from the NetEase Mail home page, click **Settings > POP3/SMTP/IMAP**, and then enable either **IMAP/SMTP service** or **POP3/SMTP service**.

Setting	Value
Primary SMTP Gateway	smtp.163.com
Primary SMTP Gateway Port	465
Use SSL/TLS	Required
Require Trusted Certificate	Disabled
Reply Address	Your email address
SMTP Server Authentication	Login/Plain
Device-Initiated Email	Use Device SMTP Credentials
Device UserID	Your email address
Device Password	Authorization password   <b>Note:</b> The authorization password is provided when IMAP/SMTP service or POP3/SMTP service is enabled.

#### NetEase Mail (mail.126.com)

 **Note:** Make sure that the SMTP service is enabled on your account.

To enable the service, from the NetEase Mail home page, click **Settings > POP3/SMTP/IMAP**, then enable either **IMAP/SMTP service** or **POP3/SMTP service**.

Setting	Value
Primary SMTP Gateway	smtp.126.com
Primary SMTP Gateway Port	465
Use SSL/TLS	Required
Require Trusted Certificate	Disabled
Reply Address	Your email address
SMTP Server Authentication	Login/Plain
Device-Initiated Email	Use Device SMTP Credentials
Device UserID	Your email address
Device Password	Authorization password   <b>Note:</b> The authorization password is provided when IMAP/SMTP service or POP3/SMTP service is enabled.

#### NetEase Mail (mail.yeah.net)

 **Note:** Make sure that the SMTP service is enabled on your account.

To enable the service, from the NetEase Mail home page, click **Settings > POP3/SMTP/IMAP**, and then enable either **IMAP/SMTP service** or **POP3/SMTP service**.

Setting	Value
Primary SMTP Gateway	smtp.yeah.net
Primary SMTP Gateway Port	465

Setting	Value
Use SSL/TLS	Required
Require Trusted Certificate	Disabled
Reply Address	Your email address
SMTP Server Authentication	Login/Plain
Device-Initiated Email	Use Device SMTP Credentials
Device UserID	Your email address
Device Password	Authorization password   <b>Note:</b> The authorization password is provided when IMAP/SMTP service or POP3/SMTP service is enabled.

#### Sohu Mail

 **Note:** Make sure that the SMTP service is enabled on your account.

To enable the service, from the Sohu Mail home page, click **Options > Settings > POP3/SMTP/IMAP**, and then enable either **IMAP/SMTP service** or **POP3/SMTP service**.

Setting	Value
Primary SMTP Gateway	smtp.sohu.com
Primary SMTP Gateway Port	465
Use SSL/TLS	Required
Require Trusted Certificate	Disabled
Reply Address	Your email address
SMTP Server Authentication	Login/Plain
Device-Initiated Email	Use Device SMTP Credentials

Setting	Value
Device UserID	Your email address
Device Password	Independent password

 **Note:** The independent password is provided when IMAP/SMTP service or POP3/SMTP service is enabled.

### Sina Mail

 **Note:** Make sure that the POP3/SMTP service is enabled on your account.

To enable the service, from the Sina Mail home page, click **Settings > More settings > User-end POP/IMAP/SMTP**, and then enable **POP3/SMTP service**.

Setting	Value
Primary SMTP Gateway	smtp.sina.com
Primary SMTP Gateway Port	587
Use SSL/TLS	Required
Require Trusted Certificate	Disabled
Reply Address	Your email address
SMTP Server Authentication	Login/Plain
Device-Initiated Email	Use Device SMTP Credentials
Device UserID	Your email address
Device Password	Authorization code

 **Note:** To create an authorization code, from the email home page, click **Settings > More settings > User-end POP/IMAP/SMTP**, and then enable **Authorization code status**.

- If you encounter errors using the settings provided, then contact your email service provider.
- For email service providers that are not on the list, contact your provider and ask for the settings.

## Sending an Email

Before you begin, make sure that the SMTP settings are configured. For more information, see [Configuring the Email SMTP Settings](#).

### Using the Control Panel

1. Load an original document into the ADF tray or on the scanner glass.
2. From the home screen, touch **Email**, and then enter the needed information.  
  
If necessary, configure the output file type settings.
3. Send the email.

### Using a Shortcut Number

1. Create an email shortcut.
  - a. Open a web browser, and then type the printer IP address in the address field.
    - View the printer IP address on the home screen. The IP address appears as four sets of numbers separated by periods, such as 123.123.123.123.
    - If you are using a proxy server, then temporarily disable it to load the web page correctly.
  - b. Click **Shortcuts > Add Shortcut**.
  - c. From the Shortcut Type menu, select **Email**, and then configure the settings.
  - d. Apply the changes.
2. Load an original document into the ADF tray or on the scanner glass.
3. From the control panel, navigate to:  
**Shortcuts > Email**  
  
For non-touch-screen printer models, press  to navigate through the settings.
4. Select the shortcut.
5. Send the email.

## Scan

### Scanning to a Computer

Before you begin, make sure that:

- The printer firmware is updated. For more information, see [Updating Firmware](#).
- The computer and the printer are connected to the same network.

#### For Windows Users

 **Note:** Make sure that the printer is added to the computer. For more information, refer to the *User Guide*.

1. Load an original document into the automatic document feeder or on the scanner glass.
2. From the computer, open **Windows Fax and Scan**.
3. From the Source menu, select a scanner source.
4. If necessary, change the scan settings.
5. Scan the document.

#### For Macintosh Users

 **Note:** Make sure that the printer is added to the computer. For more information, refer to the *User Guide*.

1. Load an original document into the automatic document feeder or on the scanner glass.
2. From the computer, do either of the following:
  - a. Open **Image Capture**.
  - b. Open **Image Capture**.
  - c. Open **Printers & Scanners**, and then select a printer. Click **Scan > Open Scanner**.
3. From the Scanner window, do one or more of the following:
  - a. Select where you want to save the scanned document.
  - b. Select the size of the original document.
  - c. To scan from the ADF, select **Document Feeder** from the Scan Menu or enable **Use Document Feeder**.
  - d. If necessary, configure the scan settings.
4. Click **Scan**.

## Fax

### Sending a Fax

#### Using the Control Panel

1. Load an original document into the automatic document feeder input tray or on the scanner glass.
2. From the home screen, touch **Fax**, then enter the required information.  
Adjust the settings, as needed.
3. Fax the document.

## Print

### Printing from a Computer

 **Note:** For labels, card stock, and envelopes, set the paper size and type in the printer before printing the document.

1. From the document that you are trying to print, open the Print dialog.
2. If necessary, adjust the settings.
3. Print the document.

### Printing from a Mobile Device

#### Printing from a Mobile Device Using Mopria™ Print Service

Mopria Print Service is a mobile printing solution for mobile devices running on Android™ version 5.0 or later. It allows you to print directly to any Mopria-certified printer.

 **Note:** Make sure that you download the Mopria Print Service application from the Google Play™ store and enable it in the mobile device.

1. From your Android mobile device, launch a compatible application or select a document from your file manager.
2. Tap **More Options > Print**.
3. Select a printer, and then adjust the settings, if necessary.
4. Tap **Print**.

#### Printing from a Mobile Device Using AirPrint®



The AirPrint software feature is a mobile printing solution that allows you to print directly from Apple devices to an AirPrint-certified printer.

- Make sure that the Apple device and the printer are connected to the same network. If the network has multiple wireless hubs, then make sure that both devices are connected to the same subnet.
  - This application is supported only in some Apple devices.
1. From your mobile device, select a document from your file manager or launch a compatible application.
  2. Tap **Share/Upload > Print**.
  3. Select a printer, and then adjust the settings, if necessary.
  4. Print the document.

#### Printing from a Mobile Device Using Wi-Fi Direct®

Wi-Fi Direct is a printing service that lets you print to any Wi-Fi Direct-ready printer.

 **Note:** Make sure that the mobile device is connected to the printer wireless network. For more information, see [Connecting a Mobile Device to the Printer](#).

1. From your mobile device, launch a compatible application or select a document from your file manager.
2. Depending on your mobile device, do one of the following:
  - Tap  > **Print**.
  - Tap  > **Print**.
  - Tap  > **Print**.
3. Select a printer, and then adjust the settings, if necessary.
4. Print the document.

## Maintain the Printer

### Attaching cables

 **CAUTION—SHOCK HAZARD:** To avoid the risk of electrical shock, do not set up this product or make any electrical or cabling connections, such as the power cord, fax feature, or telephone, during a lightning storm.

 **CAUTION—POTENTIAL INJURY:** To avoid the risk of fire or electrical shock, connect the power cord to an appropriately rated and properly grounded electrical outlet that is near the product and easily accessible.

 **CAUTION—POTENTIAL INJURY:** To avoid the risk of fire or electrical shock, use only the power cord provided with this product or the manufacturer's authorized replacement.

 **CAUTION—POTENTIAL INJURY:** To reduce the risk of fire, use only a 26 AWG or larger telecommunications (RJ-11) cord when connecting this product to the public switched telephone network. For users in Australia, the cord must be approved by the Australian Communications and Media Authority.

 **Warning:** To avoid loss of data or printer malfunction, do not touch the USB cable, any wireless network adapter, or the printer in the areas shown while actively printing.

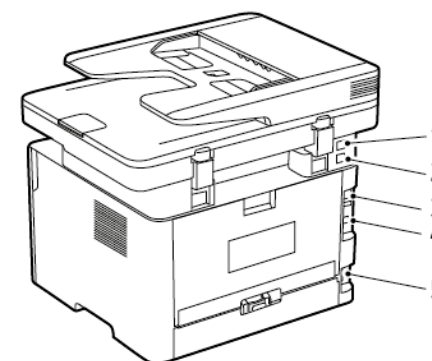

Number	Printer port	Function
1	EXT port	Connect more devices (telephone or answering machine) to the printer and the telephone line. Use this port if you do not have a dedicated fax line for the printer and if this connection method is supported in your country or region.
2	LINE port	Connect the printer to an active telephone line through a standard wall jack (RJ-11), DSL filter, or VoIP adapter, or any other adapter that allows you to access the telephone line to send and receive faxes.
3	Ethernet port	Connect the printer to a network.
4	USB printer port	Connect the printer to a computer.
5	Power cord socket	Connect the printer to a properly grounded electrical outlet.

## Replacing the Toner Cartridge

1. Open the front door.

 **Warning:** To prevent damage from electrostatic discharge, touch any exposed metal frame of the printer before accessing or touching interior areas of the printer.

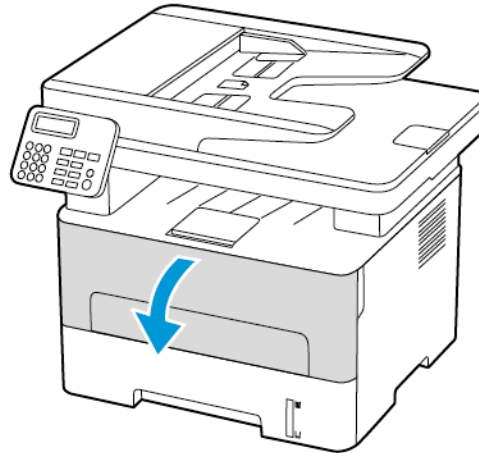

2. Remove the imaging unit.

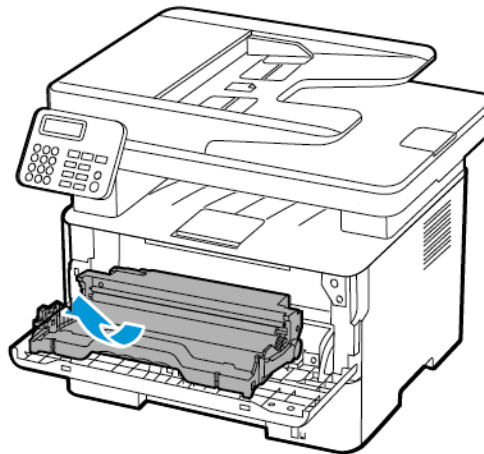

3. Remove the used toner cartridge from the imaging unit.

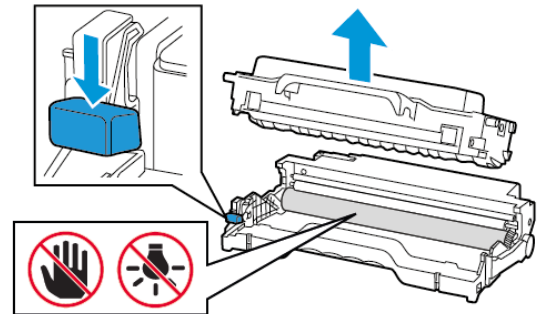

4. Unpack the new toner cartridge.
5. Shake the toner cartridge to redistribute the toner.

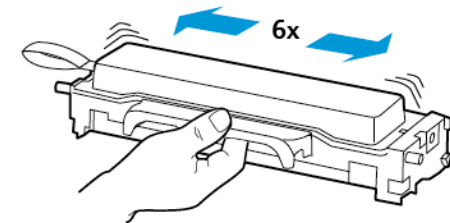

6. Remove the seal, and then remove the cover.

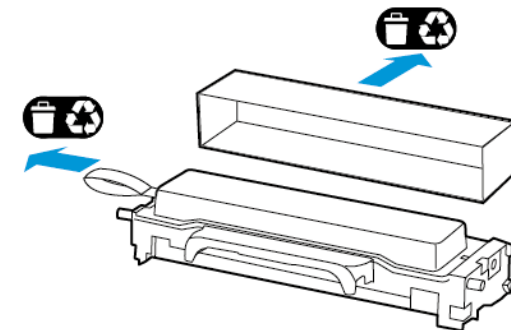

7. Insert the new toner cartridge into the imaging unit.

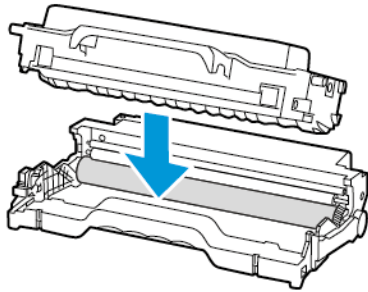

8. Insert the imaging unit.

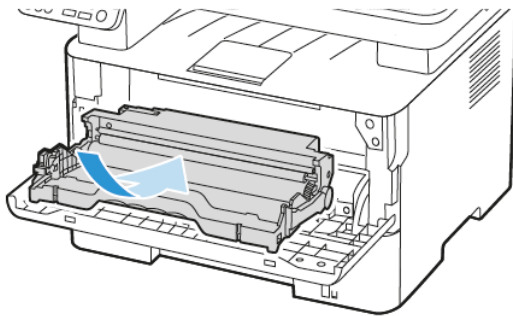

9. Close the door.

## Cleaning the Scanner

1. Open the scanner cover.

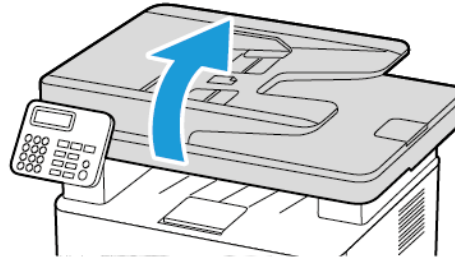

2. Using a damp, soft, lint-free cloth, wipe the following areas:

a. ADF glass pad

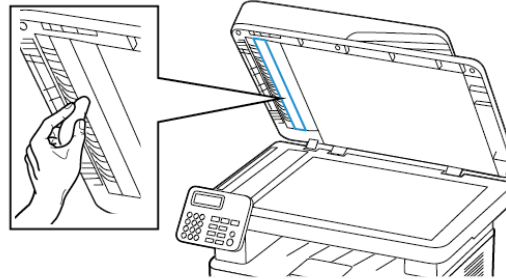

b. Scanner glass pad

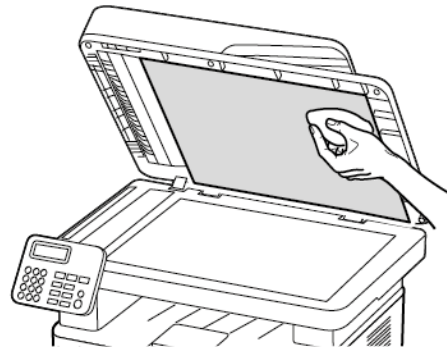

c. ADF glass

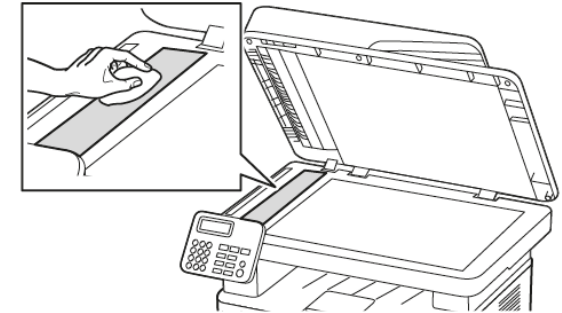

d. Scanner glass

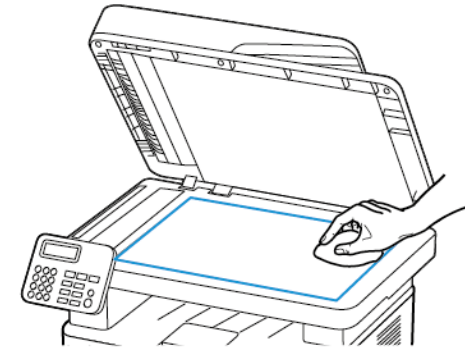

3. Close the scanner cover.



## Loading the Tray

1. Remove the tray.

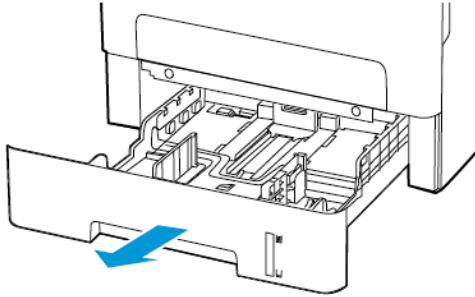

2. Adjust the paper guides to match the size of the paper that you are loading.

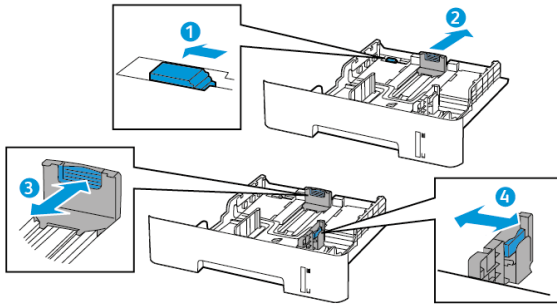

3. Flex, fan, and align the paper edges before loading.



4. Load the paper stack with the printable side facedown, and then make sure that the side guides fit snugly against the paper.

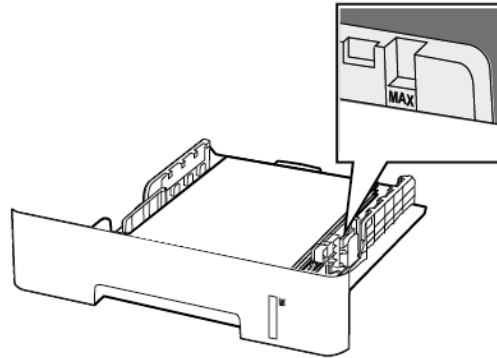

- Load letterhead facedown with the top edge of the sheet toward the front of the tray for one-sided printing.
  - Load letterhead faceup with the bottom edge of the sheet toward the front of the tray for two-sided printing.
  - Do not slide paper into the tray.
  - To avoid paper jams, make sure that the stack height is below the maximum paper fill indicator.
5. Insert the tray.

If necessary, set the paper size and paper type from the control panel to match the paper loaded.

## Loading the Manual Feeder

1. Open the manual feeder.

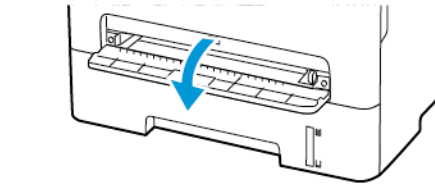
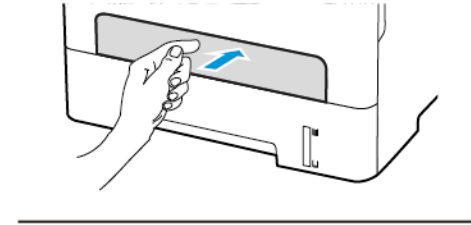

2. Adjust the guide to match the size of the paper that you are loading.

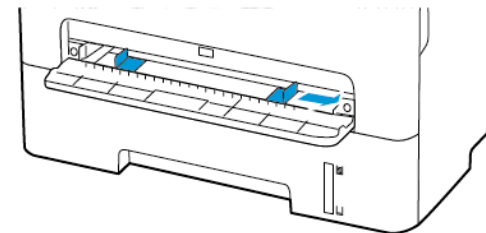

- Load a sheet of paper with the printable side faceup.
  - Load letterhead with the printable side faceup and the top edge entering the printer first for one-sided printing.
  - Load letterhead with the printable side facedown and the top edge entering the printer last for two-sided printing.
  - Load envelope with the flap side down and against the left side of the paper guide.

 **Warning:** To avoid paper jams, do not force paper into the manual feeder.

## Setting the Paper Size and Type

- From the control panel, navigate to **Settings** **PaperTray Configuration** **Paper Size/Type**, then select a paper source. For non-touch-screen printer models, to navigate through the settings, press **OK**.
- Set the paper size and type.
  - For two-sided printing on A4-size paper, make sure that the paper size setting in the duplex unit is set to A4.
  - For two-sided printing on letter-, legal-, Oficio-, or folio-size paper, make sure that the paper size setting in the duplex unit is set to Letter.

## Updating Firmware

Some applications require a minimum device firmware level to operate correctly.

For more information on updating the device firmware, contact your customer service representative.

- Open a web browser, and then type the printer IP address in the address field.
  - View the printer IP address on the printer home screen. The IP address appears as four sets of numbers separated by periods, such as 123.123.123.123.
  - If you are using a proxy server, then temporarily disable it to load the web page correctly.
- Click **Settings** > **Device** > **Update Firmware**.

- Choose one of the following:
    - Click **Check for updates** > **I agree, start update**.
    - Upload the flash file. To upload the flash file, perform the following steps. To get the latest firmware, go to [www.xerox.com](http://www.xerox.com), and search for your printer model.
      - Browse to the flash file.
-  **Note:** Make sure that you have extracted the firmware zip file.
- Click **Upload** > **Start**.

## Configuring Wi-Fi Direct

Wi-Fi Direct is a Wi-Fi-based peer-to-peer technology that allows wireless devices to connect directly to a Wi-Fi Direct-enabled printer without using an access point (wireless router).

- From the control panel, navigate to:
 

**Settings** > **Network/Ports** > **Wi-Fi Direct**

For non-touch-screen printer models, press  to navigate through the settings.
- Configure the settings.
  - Enable Wi-Fi Direct**—Enables the printer to broadcast its own Wi-Fi Direct network.
  - Wi-Fi Direct Name**—Assigns a name for the Wi-Fi Direct network.
  - Wi-Fi Direct Password**—Assigns the password for negotiating the wireless security when using the peer-to-peer connection.
  - Show Password on Setup Page**—Shows the password on the Network Setup Page.
  - Auto-Accept Push Button Requests**—Lets the printer accept connection requests automatically.

 **Note:** Accepting push-button requests automatically is not secured.

  - By default, the Wi-Fi Direct network password is not visible on the printer display. To show the password, enable the password peek icon. From the control panel, navigate to **Settings** > **Security** > **Miscellaneous** > **Enable Password/PIN Reveal**.
  - To know the password of the Wi-Fi Direct network without showing it on the printer display, from the control panel navigate to **Settings** > **Reports** > **Network** > **Network Setup Page**.

## Connecting a Mobile Device to the Printer

Before connecting your mobile device, make sure that Wi-Fi Direct has been configured. For more information, see [Configuring Wi-Fi Direct](#).

### Connecting Using Wi-Fi Direct

 **Note:** These instructions apply only to Android mobile devices.

- From the mobile device, go to the settings menu.
- Enable **Wi-Fi**, and then tap **Wi-Fi Direct**.
- Select the printer Wi-Fi Direct name.
- Confirm the connection on the printer control panel.

### Connecting Using Wi-Fi

- From the mobile device, go to the settings menu.
- Tap **Wi-Fi**, and then select the printer Wi-Fi Direct name.

 **Note:** The string DIRECT-xy (where x and y are two random characters) is added before the Wi-Fi Direct name.

- Enter the Wi-Fi Direct password.

## Connecting the Printer to a Wi-Fi Network

Before you begin, make sure that:

- Active Adapter is set to Auto. From the control panel, navigate to **Settings** > **Network/Ports** > **Network Overview** > **Active Adapter**.

For non-touch-screen printer models, press  to navigate through the settings.

- The Ethernet cable is not connected to the printer.

### Using the Wireless Setup Wizard in the Printer

- These instructions apply only to some printer models.
  - Before using the wizard, make sure that the printer firmware is updated. For more information, see [Updating Firmware](#).
- From the home screen, touch **Wi-Fi** icon, then touch **Set up now**.
  - Select a Wi-Fi network, and then type the network password.
  - Touch **Done**.

## Using the Settings Menu in the Printer

1. From the control panel, navigate to:

**Settings > Network/Ports > Wireless > Setup On Printer Panel**

For non-touch-screen printer models, press **OK** to navigate through the settings.

2. Select a Wi-Fi network, and then type the network password.

 **Note:** For Wi-Fi-network-ready printer models, a prompt to set up the Wi-Fi network appears during initial setup.

## Connecting a Computer to the Printer

Before connecting your computer, make sure to do the following:

- Enable Wi-Fi Direct in the printer. From the control panel, navigate to:

**Settings > Network/Ports > Wi-Fi Direct > Enable Wi-Fi Direct > On**

- Take note of the Wi-Fi Direct name. From the control panel, navigate to:

**Settings > Network/Ports > Wi-Fi Direct > Wi-Fi Direct Name**

- Take note of the Wi-Fi Direct password. From the control panel, navigate to:

**Settings > Network/Ports > Wi-Fi Direct > Wi-Fi Direct Password**

 **Note:** You can also configure the Wi-Fi Direct name and password.

For non-touch-screen printer models, press **OK** to navigate through the settings.

## For Windows Users

1. Open **Printers & scanners**, and then click **Add a printer or scanner**.
2. Click **Show Wi-Fi Direct printers**, and then select the printer Wi-Fi Direct name.
3. From the printer display, take note of the eight-digit PIN of the printer.

4. Enter the PIN on the computer.

 **Note:** If the print driver is not already installed, then Windows downloads the appropriate driver.

## For Macintosh Users

1. Click the wireless icon, and then select the printer Wi-Fi Direct name.

 **Note:** The string DIRECT-xy (where x and y are two random characters) is added before the Wi-Fi Direct name.

2. Type the Wi-Fi Direct password.

 **Note:** Switch your computer back to its previous network after disconnecting from the Wi-Fi Direct connection.

## Clearing Jams

### Avoiding Jams

### Load Paper Properly

- Make sure that the paper lies flat in the tray.

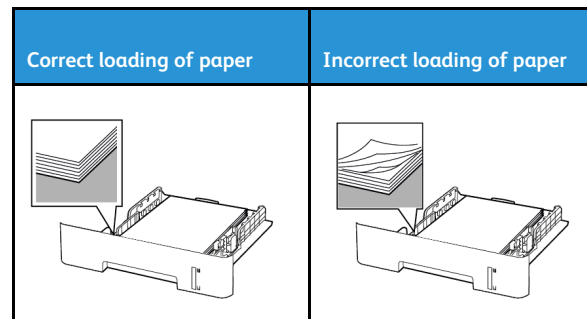

- Do not load or remove a tray while the printer is printing.
- Do not load too much paper. Make sure that the stack height is below the maximum paper fill indicator.
- Do not slide paper into the tray. Load paper as shown in the illustration.

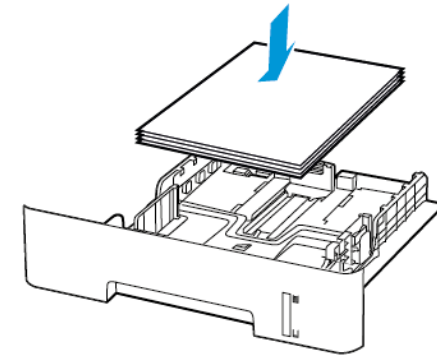

- Make sure that the paper guides are positioned correctly and are not pressing tightly against the paper or envelopes.
- For two-sided printing on A4-size paper, make sure that the paper size setting in the duplex unit is set to A4.
- For two-sided printing on letter-, legal-, Oficio-, or folio-size paper, make sure that the paper size setting in the duplex unit is set to Letter.
- Push the tray firmly into the printer after loading paper.

## Use Recommended Paper

- Use only recommended paper or specialty media.
- Do not load paper that is wrinkled, creased, damp, bent, or curled.
- Flex, fan, and align the paper edges before loading.



- Do not use paper that has been cut or trimmed by hand.
- Do not mix paper sizes, weights, or types in the same tray.
- Make sure that the paper size and type are set correctly on the computer or printer control panel.
- Store paper according to manufacturer recommendations.

## Identifying Jam Locations

- When Jam Assist is set to On, the printer flushes blank pages or pages with partial prints after a jammed page has been cleared. Check your printed output for blank pages.
- When Jam Recovery is set to On or Auto, the printer reprints jammed pages.

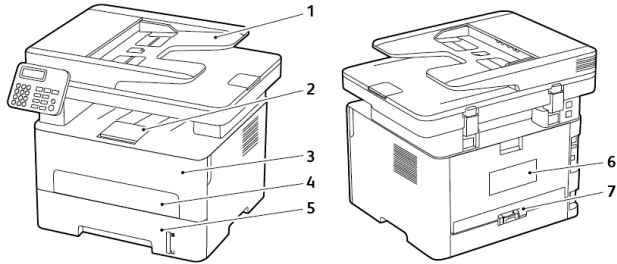

1. Automatic document feeder (ADF)
2. Standard output tray
3. Front door
4. Manual feeder
5. Tray
6. Rear door
7. Duplex unit

## Paper Jam in the Tray

1. Remove the tray.

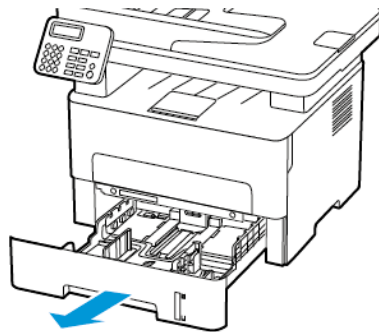

2. Remove the jammed paper.

 **Note:** Make sure that all paper fragments are removed.

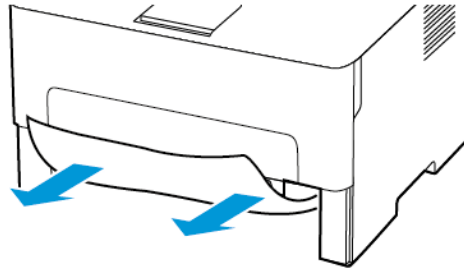

3. Insert the tray.

## Paper Jam in the Front Door

1. Open the front door.

 **Warning:** To prevent damage from electrostatic discharge, touch any exposed metal frame of the printer before accessing or touching interior areas of the printer.



2. Remove the imaging unit.

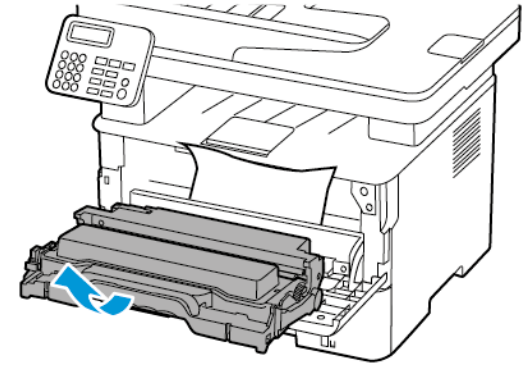

 **Warning:** Do not expose the imaging unit to direct light for more than 10 minutes. Extended exposure to light may cause print quality problems.

 **Warning:** Do not touch the photoconductor drum. Doing so may affect the quality of future print jobs.

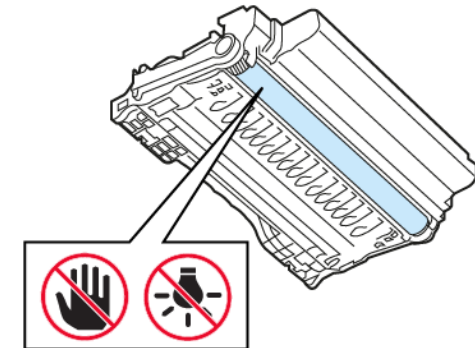

3. Remove the jammed paper.



**CAUTION—HOT SURFACE:** The inside of the printer might be hot. To reduce the risk of injury from a hot component, allow the surface to cool before touching it.



**Note:** Make sure that all paper fragments are removed.

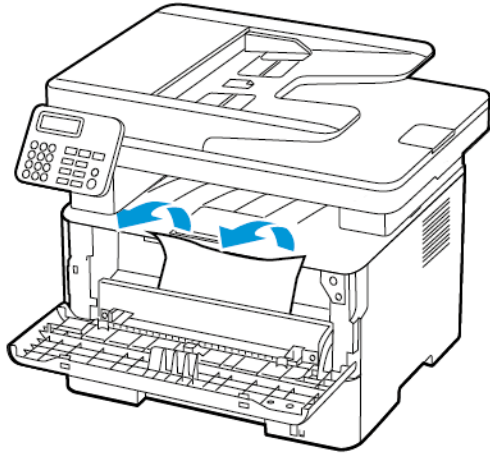

4. Insert the imaging unit.

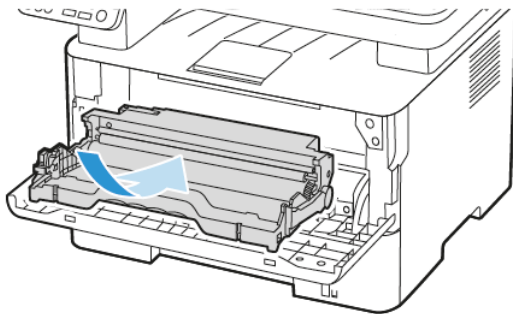

5. Close the door.

## Paper Jam in the Rear Door

1. Open the rear door.



**CAUTION—HOT SURFACE:** The inside of the printer might be hot. To reduce the risk of injury from a hot component, allow the surface to cool before touching it.

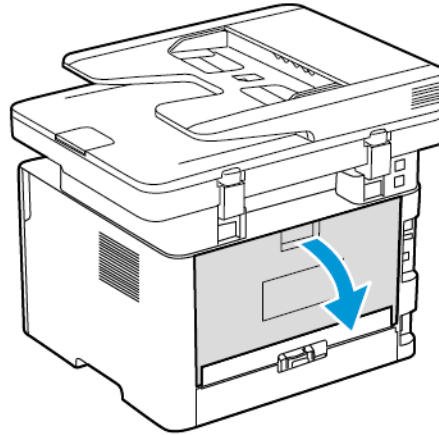

2. Open the fuser access door.

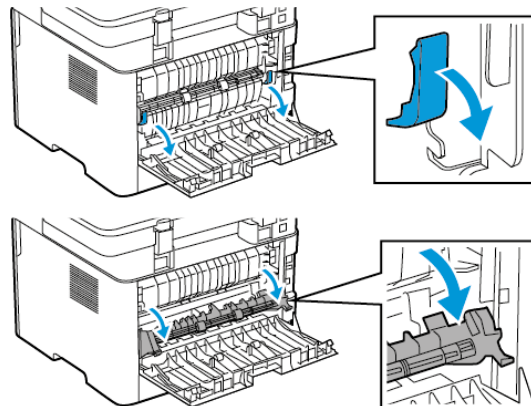

3. Remove the jammed paper.



**Note:** Make sure that all paper fragments are removed.

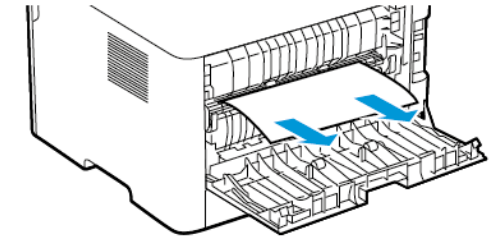

4. Close the fuser access door.
5. Close the rear door.

## Paper Jam in the Duplex Unit

1. Pull out the duplex unit, and then remove the jammed paper.



**Warning:** To prevent damage from electrostatic discharge, touch any exposed metal frame of the printer before accessing or touching interior areas of the printer.

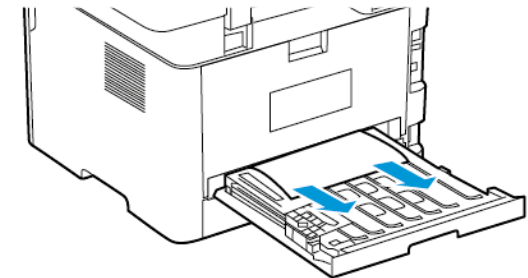

**Note:** Make sure that all paper fragments are removed.

2. Insert the duplex unit.

## Paper Jam in the Standard Output Tray

1. Raise the scanner, and then remove the jammed paper.

 **Note:** Make sure that all paper fragments are removed.

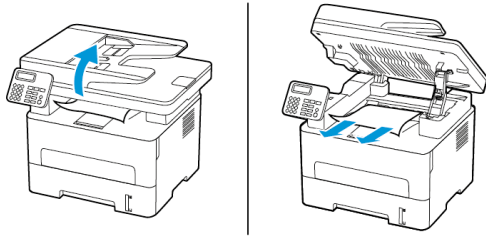

2. Lower the scanner.

## Paper Jam in the Manual Feeder

Remove the jammed paper.

 **Note:** Make sure that all paper fragments are removed.

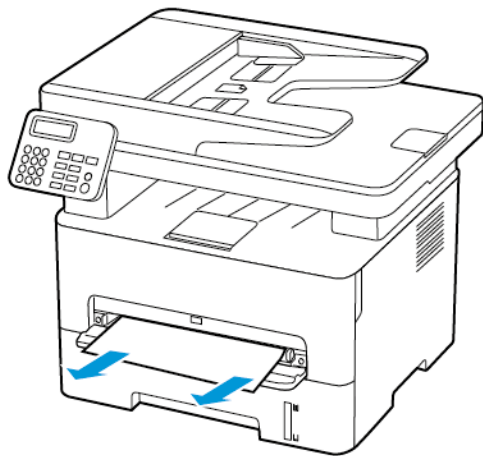

## Paper Jam in the Automatic Document Feeder

1. Remove all original documents from the ADF tray.
2. Open the ADF cover.

 **Warning:** To prevent damage from electrostatic discharge, touch any exposed metal frame of the printer before accessing or touching interior areas of the printer.

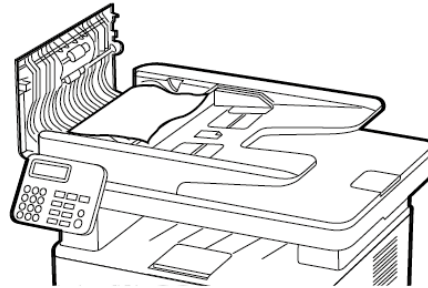

3. Remove the jammed paper.

 **Note:** Ensure that all paper fragments are removed.

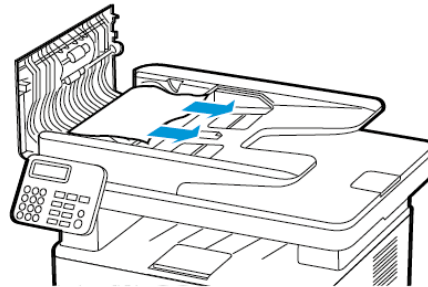

4. Close the ADF cover.

5. Open the scanner cover.

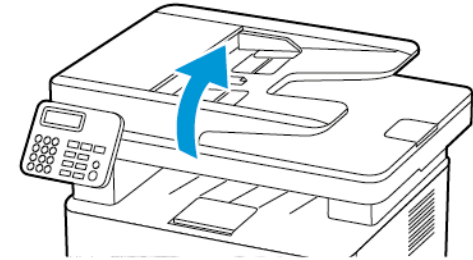

6. Remove the jammed paper.

 **Note:** Make sure that all paper fragments are removed.

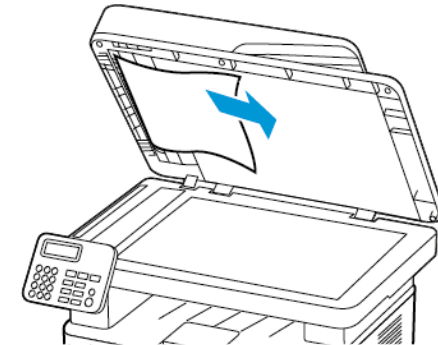

7. Close the scanner cover.



© 2021 Xerox Corporation. All rights reserved. Xerox® is a trademark of Xerox Corporation in the United States and other countries.

Apple®, iPad®, iPhone®, iPod®, iPod touch®, AirPrint® and the AirPrint Logo® are trademarks or registered trademarks of Apple Inc. in the U.S. and other countries. Google Cloud Print™ web printing service, Gmail™ webmail service, and Android™ mobile technology platform are trademarks of Google, Inc. Microsoft®, Windows Vista®, Windows®, Windows Server®, and OneDrive® are registered trademarks of Microsoft Corporation in the United States and other countries. Mopria is a trademark of the Mopria Alliance. Wi-Fi CERTIFIED Wi-Fi Direct® is a trademark of the Wi-Fi Alliance. All other trademarks are the property of their respective owners. 702P08610

BR32748

607E39590