

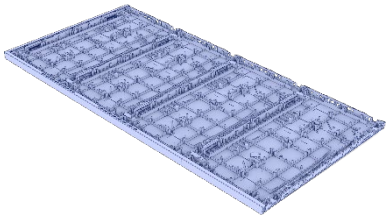

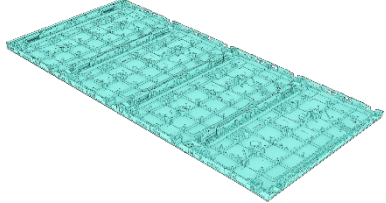

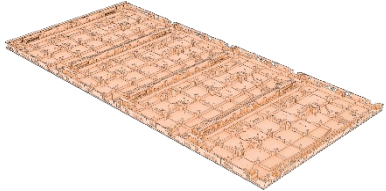

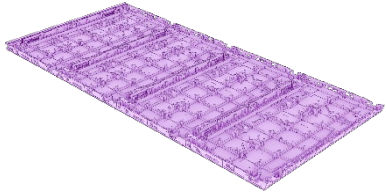

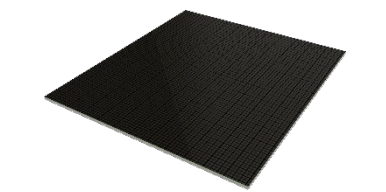
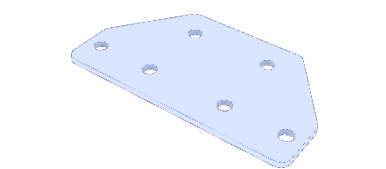

UWC196 Ultra-Wide LED Display

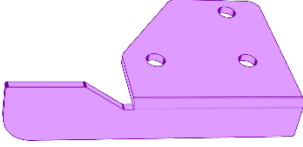
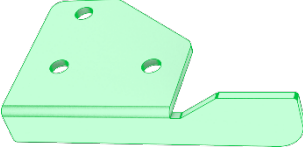
Installation Guide

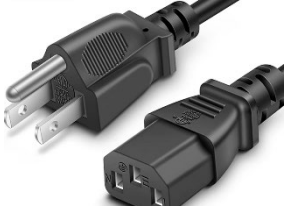
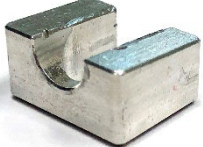

1. LED Display Parts List

Item	Image	Part Name	Quantity	Note.
1		Unit Chassis 1	2 PCS	<ul style="list-style-type: none"> The inner sides of the five cabinets that make up Unit Chassis 1 are labeled with numbers 1 to 4.
2		Unit Chassis 2	2 PCS	<ul style="list-style-type: none"> The inner sides of the five cabinets that make up Unit Chassis 2 are labeled with numbers 5 to 8.
3		Unit Chassis 3	2 PCS	<ul style="list-style-type: none"> The inner sides of the five cabinets that make up Unit Chassis 3 are labeled with numbers 9 to 12.
4		Unit Chassis 4	2 PCS	<ul style="list-style-type: none"> The inner sides of the five cabinets that make up Unit Chassis 4 are labeled with numbers 13 to 16.
6		Bottom Frame 1	2 Set	<ul style="list-style-type: none"> This part is mounted on the left side of the frame module beneath the UW196. It must be assembled together with the "Bottom Frame 2" before it can be used.
7		Bottom Frame 2	2 Set	<ul style="list-style-type: none"> This part is mounted on the right side of the frame module beneath the UW196. It must be assembled together with the "Bottom Frame 1" before it can be used.
8		LED Panel	400 PCS	<ul style="list-style-type: none"> The LED panel is a key component in assembling the UW196 screen. Its mounting surface features a POKA-YOKE design to prevent incorrect installation.
9		Wall-mounted bracket connector piece	4 PCS	<ul style="list-style-type: none"> This part is used to connect & secure the wall-mount bracket 1 & 2 components, integrating them into a single unit.







10		Stopper Plate-L	2 PCS	<ul style="list-style-type: none"> This is the stopper component installed at the left end of the wall mount sliding rail, used to prevent the mounted display from sliding off.
11		Stopper Plate-R	2 PCS	<ul style="list-style-type: none"> This is the stopper component installed at the right end of the wall mount sliding rail, used to prevent the mounted display from sliding off.
12		Wall-mounted bracket 1	8 PCS	<ul style="list-style-type: none"> Provides left structure for LED display unit to wall or rolling stand.
13		Left-angle FFC cable	2 PCS	<ul style="list-style-type: none"> The length is 416mm. This cable is used to connect the system board of the bottom-side frame to the distribution board of Unit Chassis 2.
14		Right-angle FFC cable	2 PCS	<ul style="list-style-type: none"> The length is 273mm. This cable is used to connect the system board of the bottom-side frame to the distribution board of Unit Chassis 3.
15		FFC cable	4 PCS	<ul style="list-style-type: none"> The length is 529mm. This FFC cable is a signal cable used to connect Unit Chassis 1 & 2, Unit Chassis 2 & 3, and Unit Chassis 4 & 5.
16		Power cord	2 PCS	<ul style="list-style-type: none"> This is the power cord used to supply AC power to the UW196. The UW196 offers four types of power cords for customers to choose from: US standard, UK standard, EU standard, and Australia standard.
17		Locking block	16 PCS	<ul style="list-style-type: none"> This is a fastening component used to assemble the bottom frame to the chassis. This part is used in combination with the fixing pin of the bottom frame.
18		M8 Expansion Bolt	48 PCS	<ul style="list-style-type: none"> This is a Expansion Bolt used to secure the UW196 wall-mount bracket to a concrete or brick wall. This bolt is operated with a 13mm Hex Socket Wrench.

19		M6x10mm screw	24 PCS	<ul style="list-style-type: none"> This screw is used to secure the wall mount bracket components into a single unit.
20		Large pan head M3x8mm	16 PCS	<ul style="list-style-type: none"> This screw is fastened onto the fixing pin of the bottom frame to ensure that the locking block installed on it does not come loose.
21		M3x6mm screw with washer	6 PCS	<ul style="list-style-type: none"> This screw is used to secure Bottom Frame 1 and Bottom Frame 2 as a single assembled unit.
22		M3x8mm screw with washer	2 PCS	<ul style="list-style-type: none"> This screw is intended for mounting the Wi Fi antenna from the option kit within the system control box.
23		RJ45 to RS232 cable	1 PCS	<ul style="list-style-type: none"> Intended for RS232 control.

2. Assembly Kits Box-Parts List

Item	Image	Part Name	Quantity	Note.
1		Positioning Pin and Spring	8 SET	<ul style="list-style-type: none"> This component is installed on Unit Chassis 1 of the SIDE-B. This component is used for calibration and positioning the joining surface between the two unit chassis during assembly.
2		System bar connection plate	1 PCS	<ul style="list-style-type: none"> This component is used to combine the system bars of the two spliced UW196 displays into a single, unified structure.
3		M3x6mm screw with washer	4 PCS	<ul style="list-style-type: none"> This screw is used to secure the system bar connection plate.
4		FFC cable	2 PCS	<ul style="list-style-type: none"> This cable is used to transmit signals between the two spliced UW196 displays during the assembly process.
5		Speaker extension cable	2 PCS	<ul style="list-style-type: none"> This is the cable used to link and transmit speaker signals between the system bars of the two spliced UW196 displays.
6		PSU synchronization signal cable	1 PCS	<ul style="list-style-type: none"> This is a PSU synchronization signal cable used to connect the internal PSUs of two spliced UW196 display systems.

3. List of Tools and Accessories Used

Item	Image	Part Name	Quantity	Note.
1		Phillips Screwdriver	1 PCS	<ul style="list-style-type: none"> Tools for removing and installing Phillips head screws.
2		No. 5 hexagonal wrench	1 PCS	<ul style="list-style-type: none"> This tool is used for operating the side hook mechanism inside the unit chassis for assembling or disassembling.
3		13mm Open-End Hex Wrench	1 PCS	<ul style="list-style-type: none"> This tool is used for fastening or removing the nut of the rivet bolt and the M8 screws used in the entire unit.
4		13mm Socket Hex Wrench	1 PCS	<ul style="list-style-type: none"> This tool is used for fastening or removing the nut of the rivet bolt and the M8 screws used in the entire unit.
5		Magnet Height Adjustment Tool	2 PCS	<ul style="list-style-type: none"> Tool for adjusting the height of magnet bolts inside the display chassis that secure the LED panel to the magnetic supports.
6		Vacuum Suction Tool	1 PCS	<ul style="list-style-type: none"> This is a vacuum suction tool specifically used for assembling and disassembling COB LED panels.
7		Magnetic Pickup Tool	1 PCS	<ul style="list-style-type: none"> This is a magnetic tool used for removing the cover plate of the bottom frame.
8		Anti-static Gloves	5 PCS	<ul style="list-style-type: none"> Wearing these gloves helps the technicians eliminate static and protect the LED display during the assembly or maintenance of the UW196.

4. Wall-Mounted Brackets Installation Guide

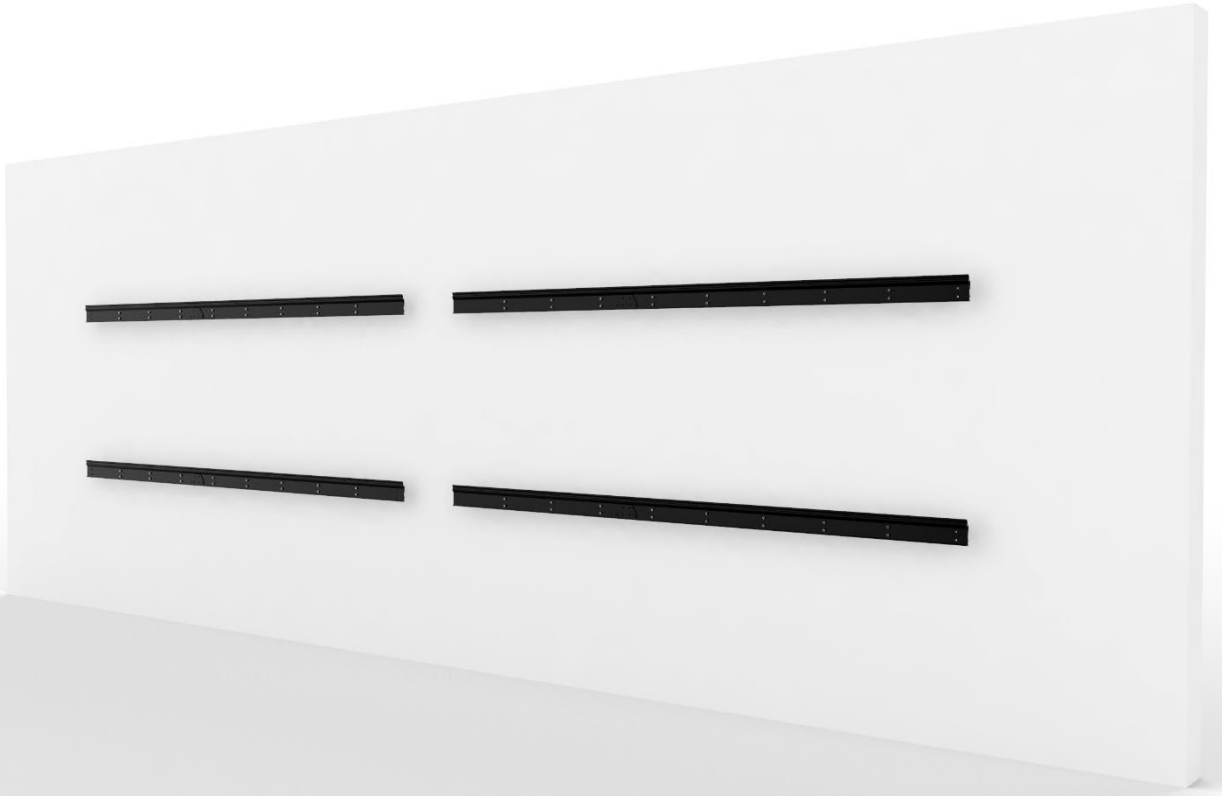

Wall-Mount Bracket Installation Render for UWC196 Ultra-Wide LED Display Installation.

Installation steps :

- 1) According to the on-site environment, combined with the height of the large screen from the ground, determine the drilling positions of the upper and lower wall mounts. To ensure horizontal alignment, a spirit level is required.
- 2) Each LED display has its own upper and lower wall-mount brackets, which are composed of Wall-Mount Bracket 1 and Wall-Mount Bracket 2, respectively. These brackets are connected using a connector piece and secured with six M6*10 countersunk screws.

-
- 3) Install the Stopper Plate-L and Stopper Plate-R at the left and right ends of the upper wall mount using six M6*10mm pan head screws. These plates prevent the LED display from sliding on the wall mount beyond the safe tolerance.

Step 1. Assembly diagram of the upper and lower wall mount bodies

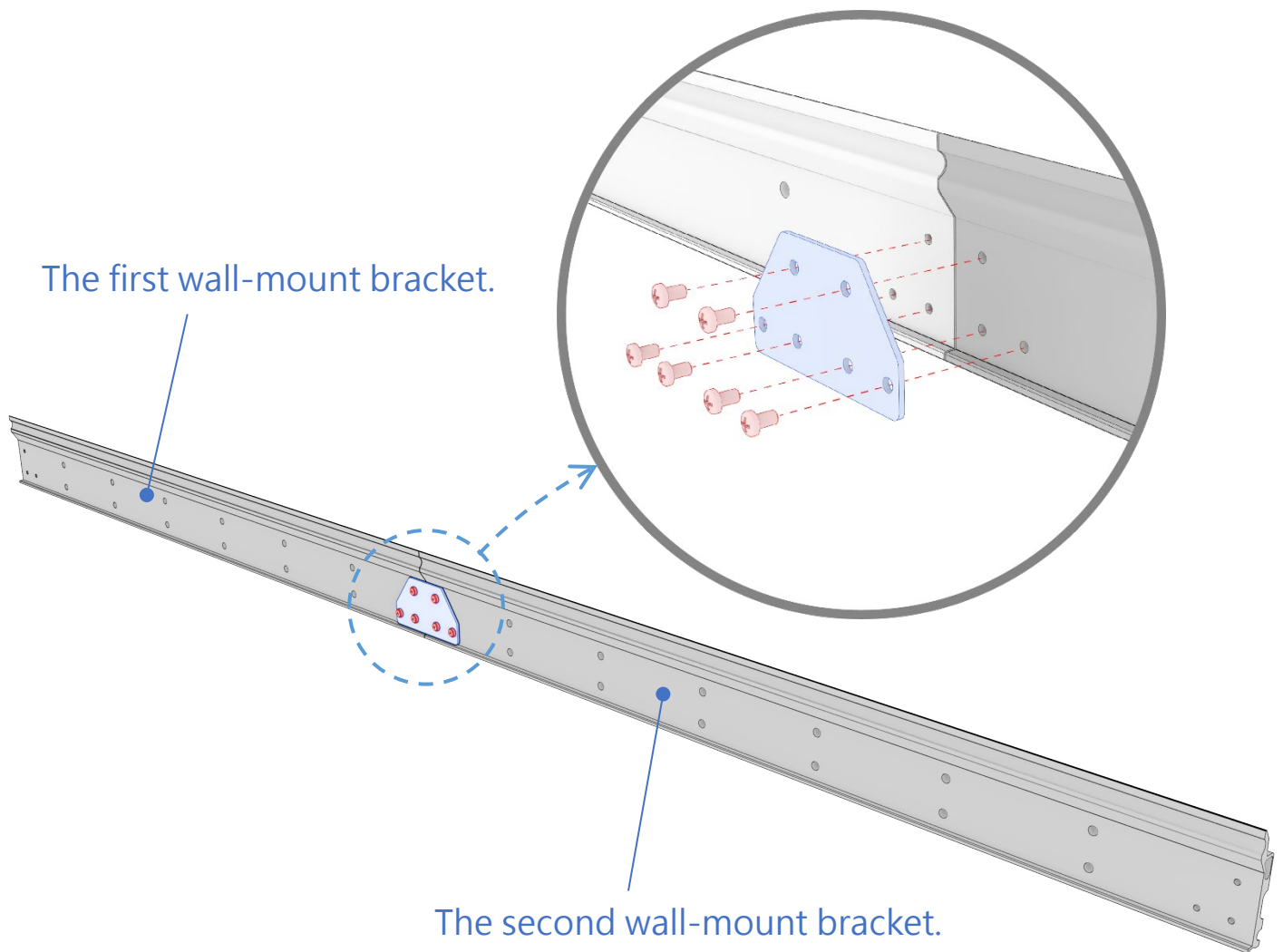

Step 2. Assembly diagram of Stopper-L & Stopper-R parts on the upper wall mount.

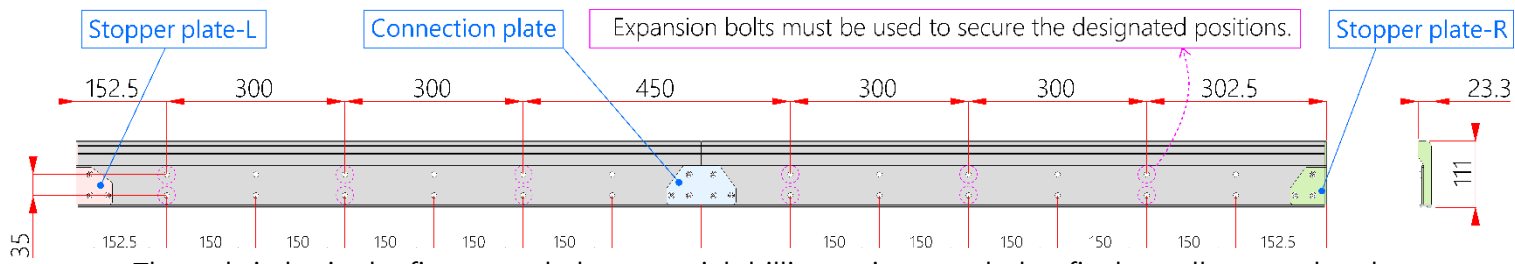
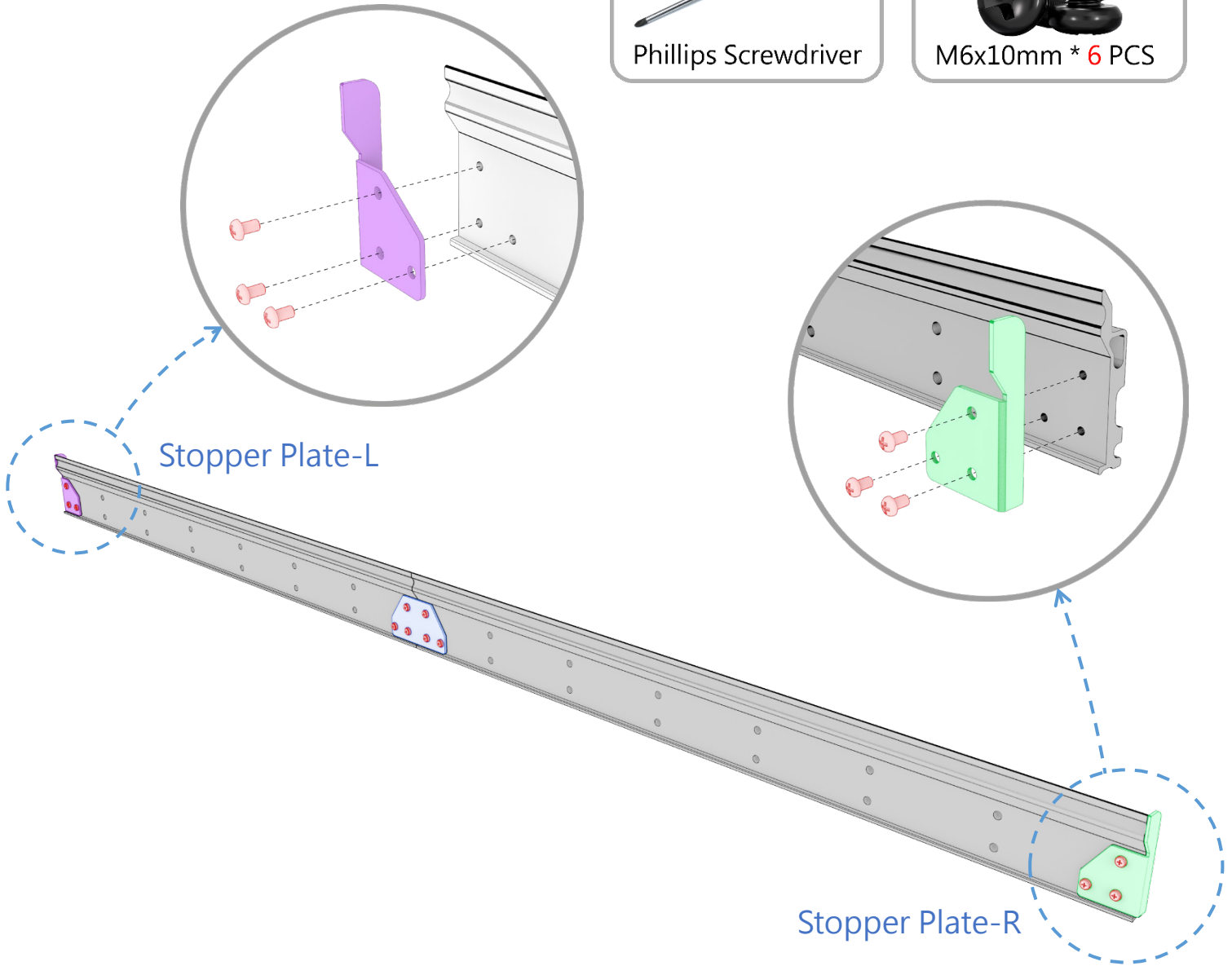

- The red circles in the figure mark the essential drilling points needed to fix the wall-mount bracket.

4) Mounting Point Diagram for Wall Brackets in UWC196 Ultra-Wide LED display Assembly.

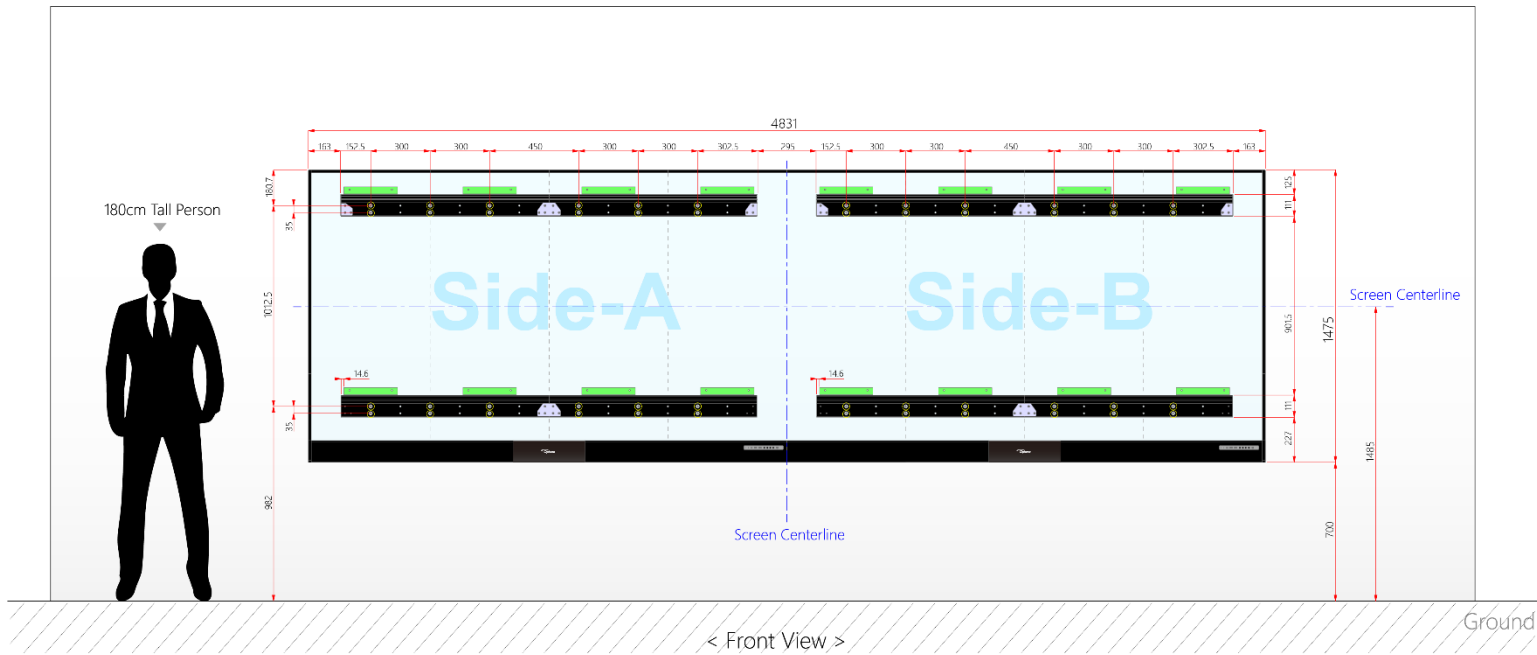

- 1) The 32:9 LED display shown in the image is composed of two LED displays spliced together horizontally. The left display is labeled as Side-A, while the right display is named Side-B.
- 2) The 48 yellow circles marked in the diagram indicate the minimum screw lock points and quantity required to secure the wall-mount bracket for the UWC196 Ultra-wide LED display.
- 3) The pink-colored area in the image is the Hook Plate for the UWC196 Ultra-Wide LED display chassis.
- 4) Mark the appropriate hole positions on the wall and drill holes at the marked points using a tool, with each hole having a diameter of 10mm.
- 5) Use 40 M8*80 expansion bolt for installation at the corresponding hole position, as shown in the figure below :



1) Side sectional view of the installed wall mount.

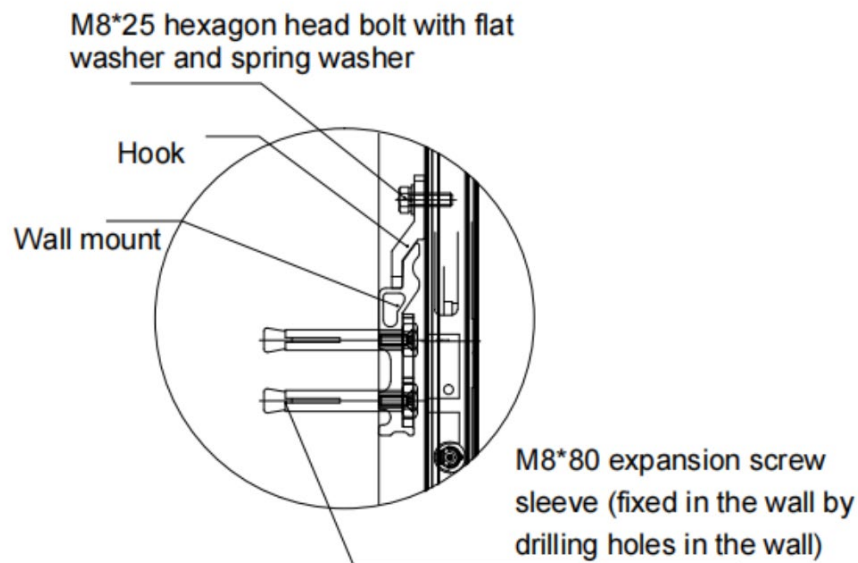

- 2) The front view of the installed wall mounts is as shown in the figure below. The upper hanging bar and lower hanging bar are parallel to the ground and aligned up and down with each other. The distance between them is [1012.5mm](#).
- 3) Check if the wall mount is installed properly, by determining : 1) if it is level; 2) if the distance between the upper and lower wall mounts is correct. You can check and adjust using the following methods :

- I. Use a spirit level to measure if the wall mount is level. If it is not level, adjust it by loosening the expansion bolts, gently push it to be level by hand, then tighten the bolts.
 - II. Use a tape measure to check if the distance between the upper and lower wall mounts is correct. If it is incorrect, adjust it by loosening the expansion bolts, lightly pushing to adjust the distance by hand, and then tightening the bolts.
- 4) Install the cabinets according to the installation steps of those for the floor standing installation.

5. UWC196 Ultra-Wide LED display Chassis Installation

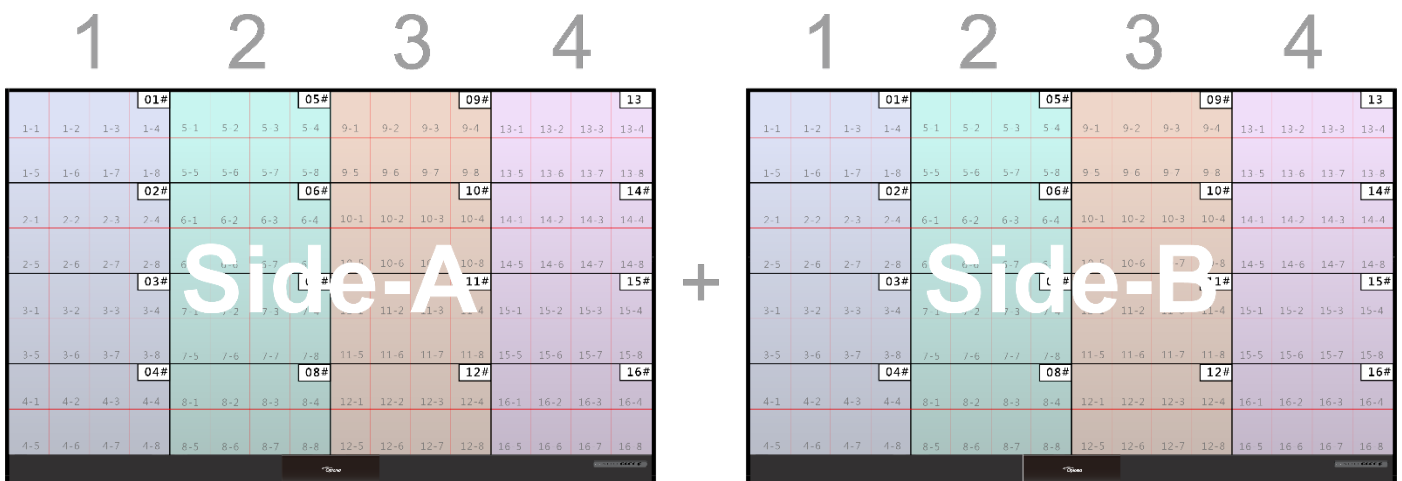

Naming and Unit Chassis Numbering Diagram for the 32:9 UWC196 Ultra-Wide LED display Assembly

The 32:9 UWC196 Ultra-Wide LED display is formed by two horizontally LED display units. For clarity in this document, the display on the left side is referred to as Side-A, and the display on the right side is referred to as Side-B.

Both Side-A and Side-B displays consist of four Unit Chassis, numbered 1 through 4. The

32:9 display is formed by connecting Unit Chassis 4 of Side-A with Unit Chassis 1 of Side-B.

Step 1 : Identifying and Distinguishing the Unit Chassis of the UWC196 Display

- 1) The unit chassis assembled in columns have been pre-installed with back hooks and edging.
- 2) The integrated LED display is shipped with the unit chassis arranged in a column according to their numbers, with a total of 8 columns arranged for UW196.
- 3) The method to distinguish the unit chassis numbers of the 4 columns of the UWC196 is by identifying the label numbers attached to the inside of each cabinet. As shown in the diagram :
 - Cabinet label numbers 1–4 correspond to unit Chassis 1.
 - Cabinet label numbers 5–8 correspond to unit Chassis 2.
 - Cabinet label numbers 9–12 correspond to unit Chassis 3.

- Cabinet label numbers 13–16 correspond to unit Chassis 4.

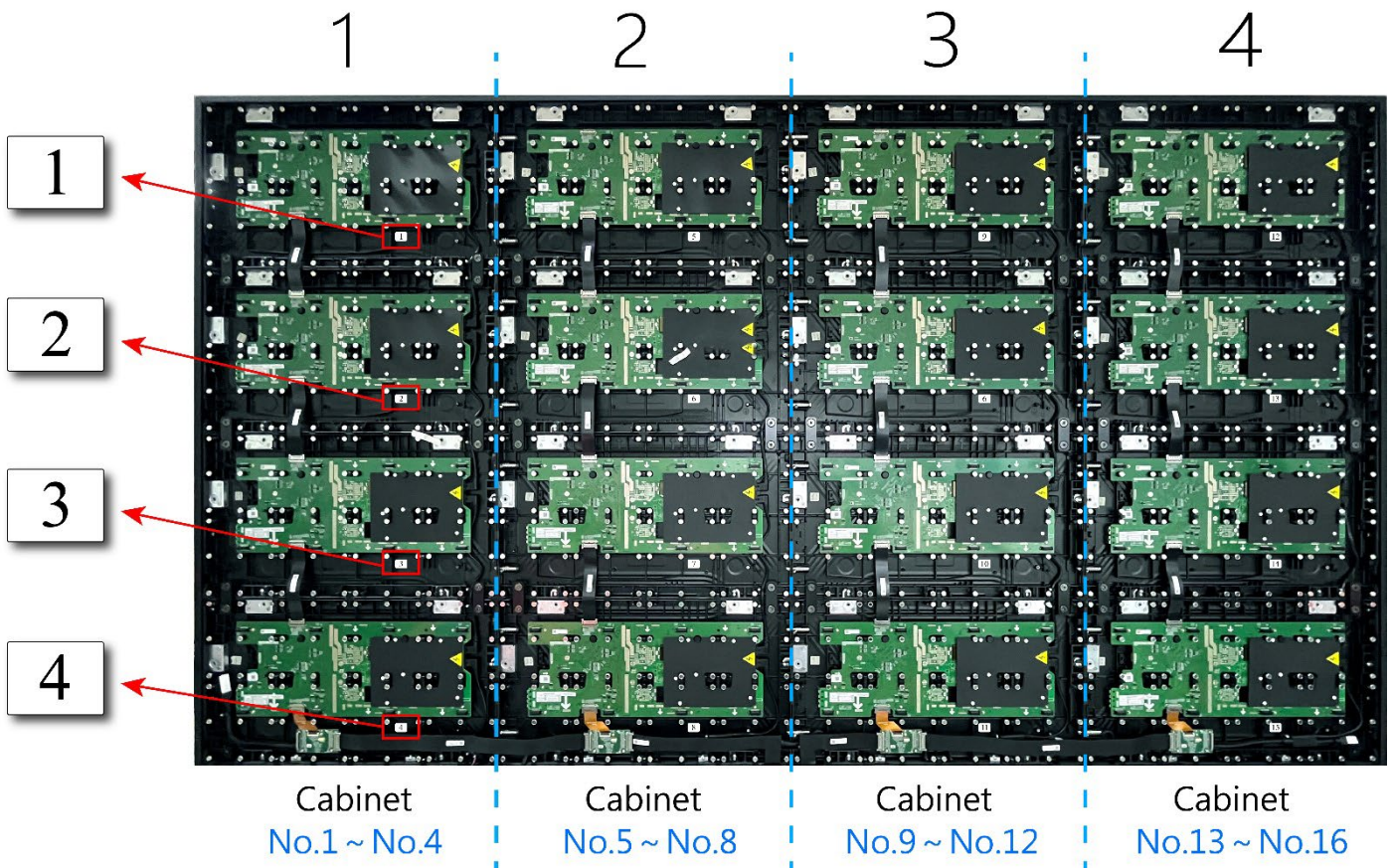

Step 2 : Remove the bezel & speaker modules at the interface of the two displays

The Side-A and Side-B displays each have three components that must be removed before proceeding with the subsequent assembly. These three components are :

1. Upper Bezel
2. Lower Bezel
3. End Caps.

Side-A display
Unit
Chassis 4

Side-B display
Unit
Chassis 1

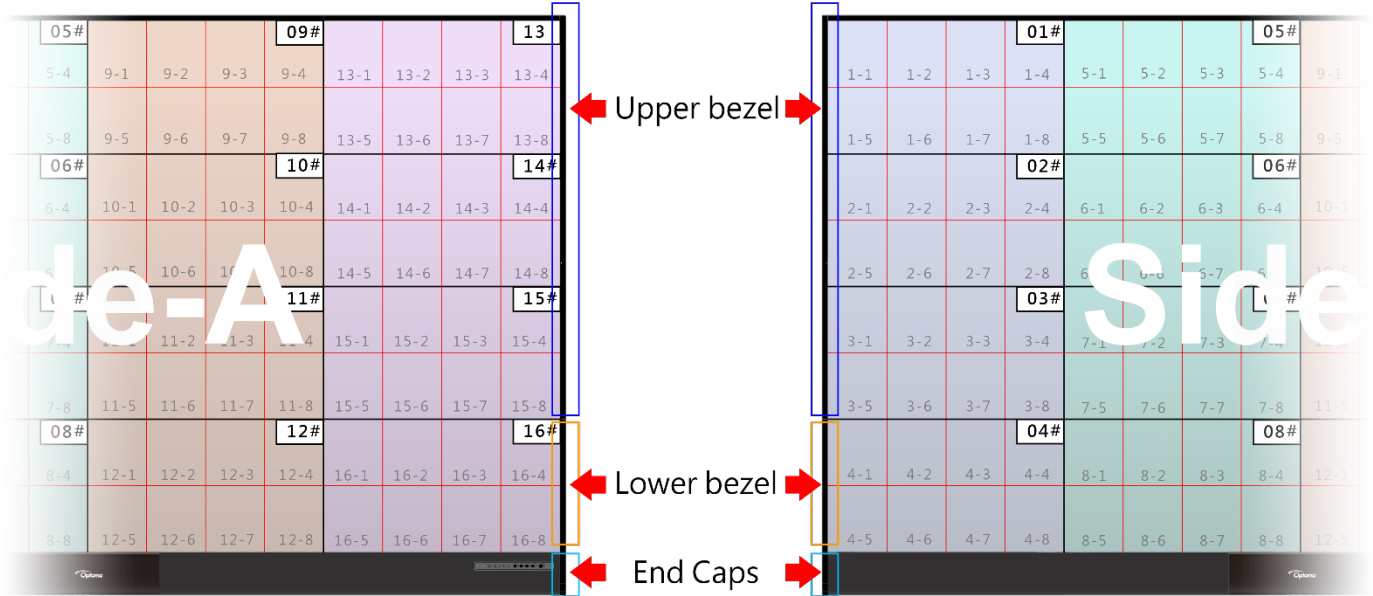

1. First, use a 13mm open-end hex wrench to turn counterclockwise and loosen the nuts marked with red circles in the image. Both the Side-A and Side-B display have six nuts each that must be removed.

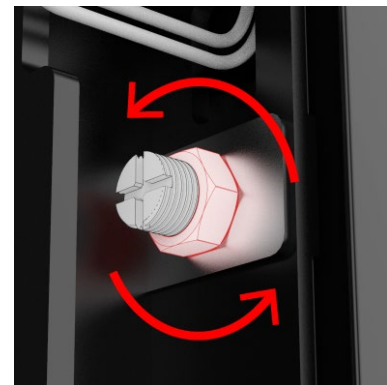
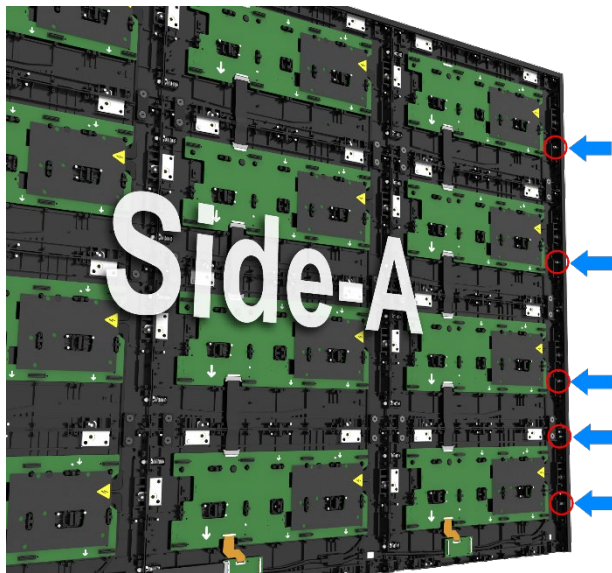

- Please use a 13mm open-end hex wrench to remove the five nuts located at the red-circled positions on the Side-A Unit Chassis 4, as shown in the image.

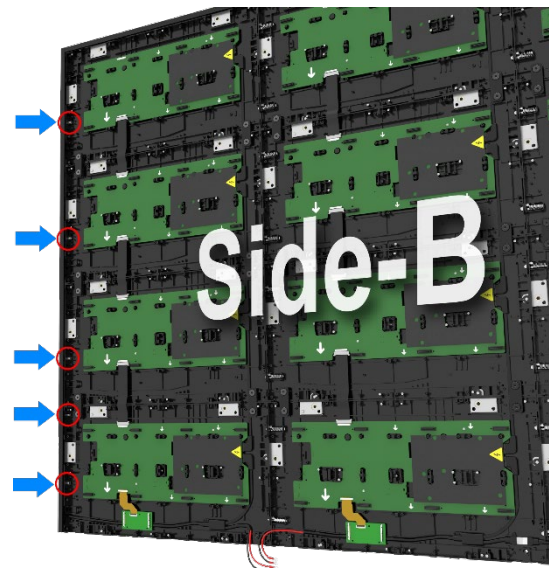
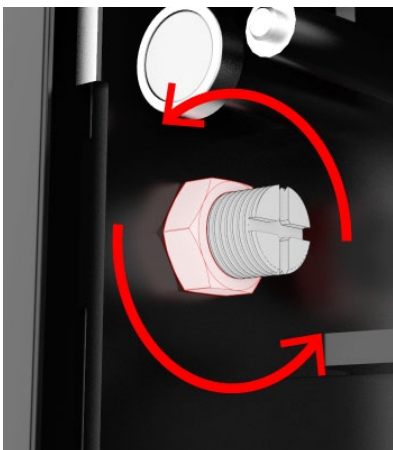

- The Side-B display Unit Chassis 1 also has five nuts that must be removed. Their locations are marked with red circles in the image.

2. After removing the audio boards and the nuts as described above, the bezels attached to the sides of the Side-A and Side-B LED display can then be removed. This bezel removal step is performed by hand.

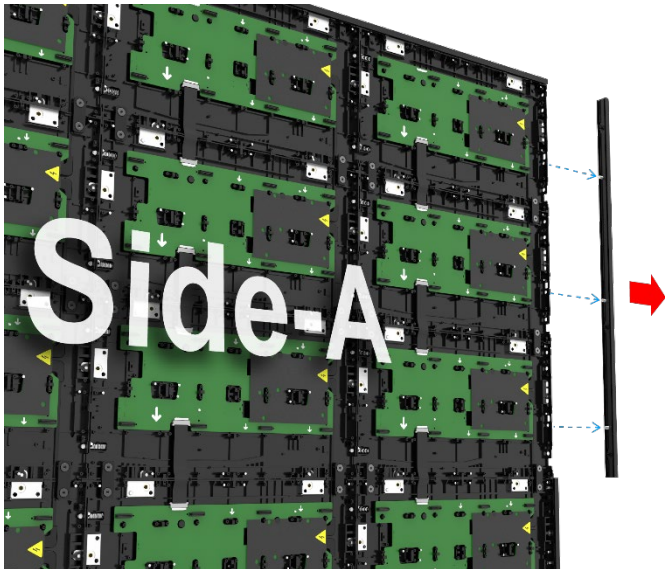

- As shown in the image, carefully remove the upper bezel module located on **Unit Chassis 4** of the Side-A display.



- As shown in the image, carefully remove the upper bezel module located on **Unit Chassis 1** of the Side-B display.



- Next, remove the lower side bezel of **Unit Chassis 4** by following the direction indicated by the arrow in the image.

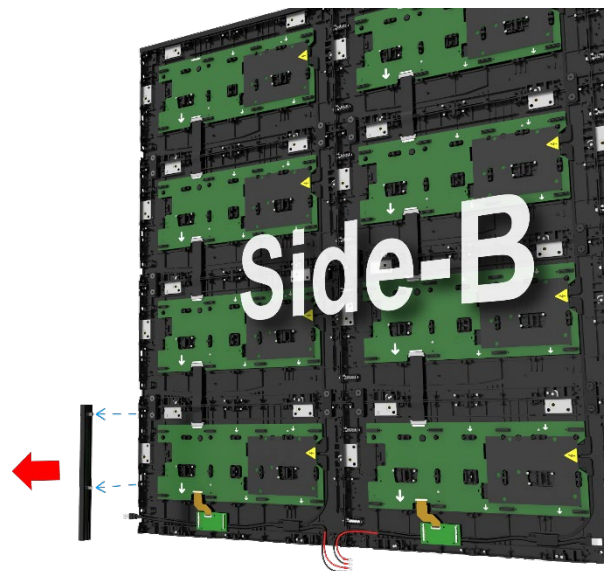

- Next, remove the lower side bezel of **Unit Chassis 1** by following the direction indicated by the arrow in the image.

-
3. Next, remove the right-side end cap of the Side-A system bar and the left-side end cap of the Side-B system bar.

Use a Phillips screwdriver to unscrew the **two M3 screws** marked by red circles in the diagram. Once the screws are removed, you can detach the end caps.

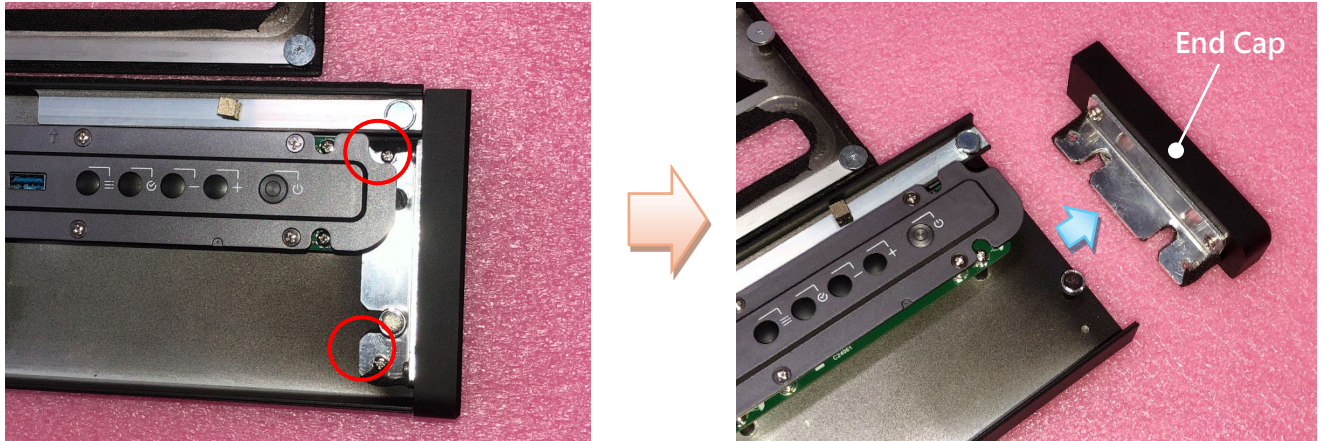

- Illustration of Right-Side End Cap Removal for Side-A System Bar.



- Illustration of Left-Side End Cap Removal for Side-B System Bar

Step 3 : Assemble the positioning pin and spring

Next, assembly 8 sets of [Position Pins & Springs](#) on the left side of the Side-B Unite chassis 1. The installation points are marked by the yellow box in the image below.

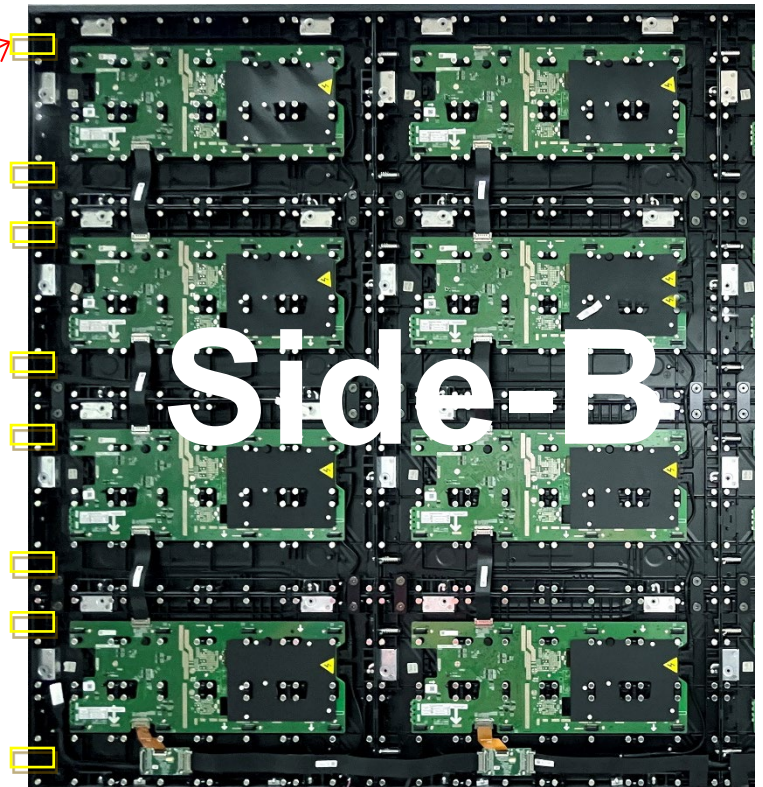

The following are the operating steps for assembling the Position Pin & Spring onto the Unit chassis :

1. Insert the Spring component into the positioning pin slot on the inner side of the chassis, there are a total of 8 positions.



Spring

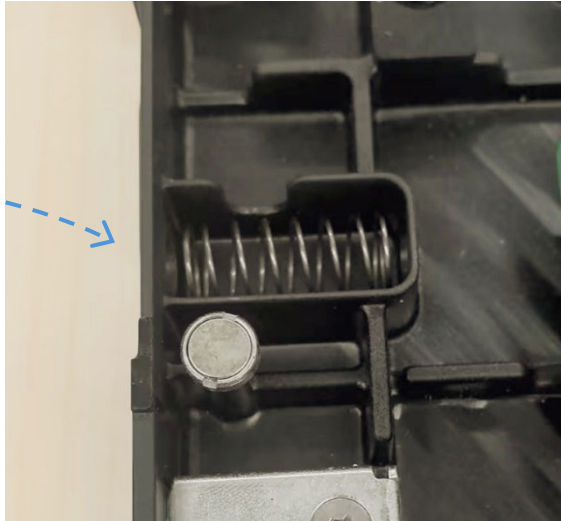

Position Pin

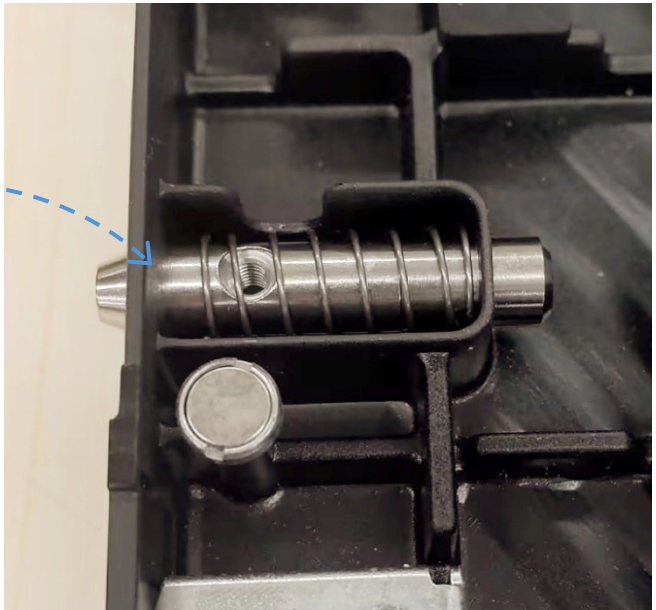

2. Next, as shown in the image, insert the Position Pin through the Spring inside the slot, ensuring it is also properly seated within the slot.

-
3. Finally, fasten the knob screw onto the Position Pin so that it can receive the reactive force from the compressed spring, allowing the guiding head of the Position Pin to protrude from the Unit Chassis as intended.



Knob Screw

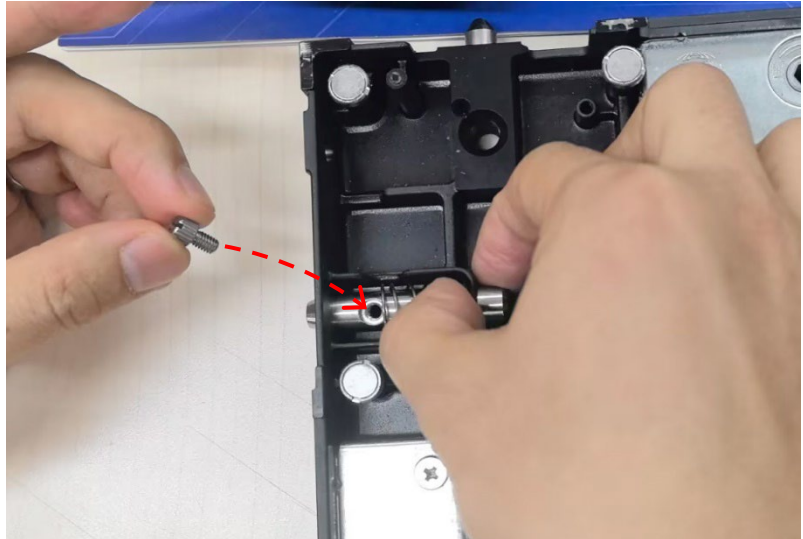

- As shown in the image, push the spring aside to ensure the screw hole on the Position Pin is not obstructed, then fasten the knob screw into the screw hole.



- The knob screw may be additionally secured using a flathead screwdriver to prevent loosening.

Step 4 : Assembly Sequence of Unit Chassis

Assemble the 32:9 screen by sequentially mounting and connecting the ten unit chassis belonging to **Side-A** and **Side-B** in the order shown in the diagram below. Please follow the numbered sequence **from 1 to 8** to hang each unit chassis onto the wall-mount brackets and complete the assembly by joining each adjacent pair.

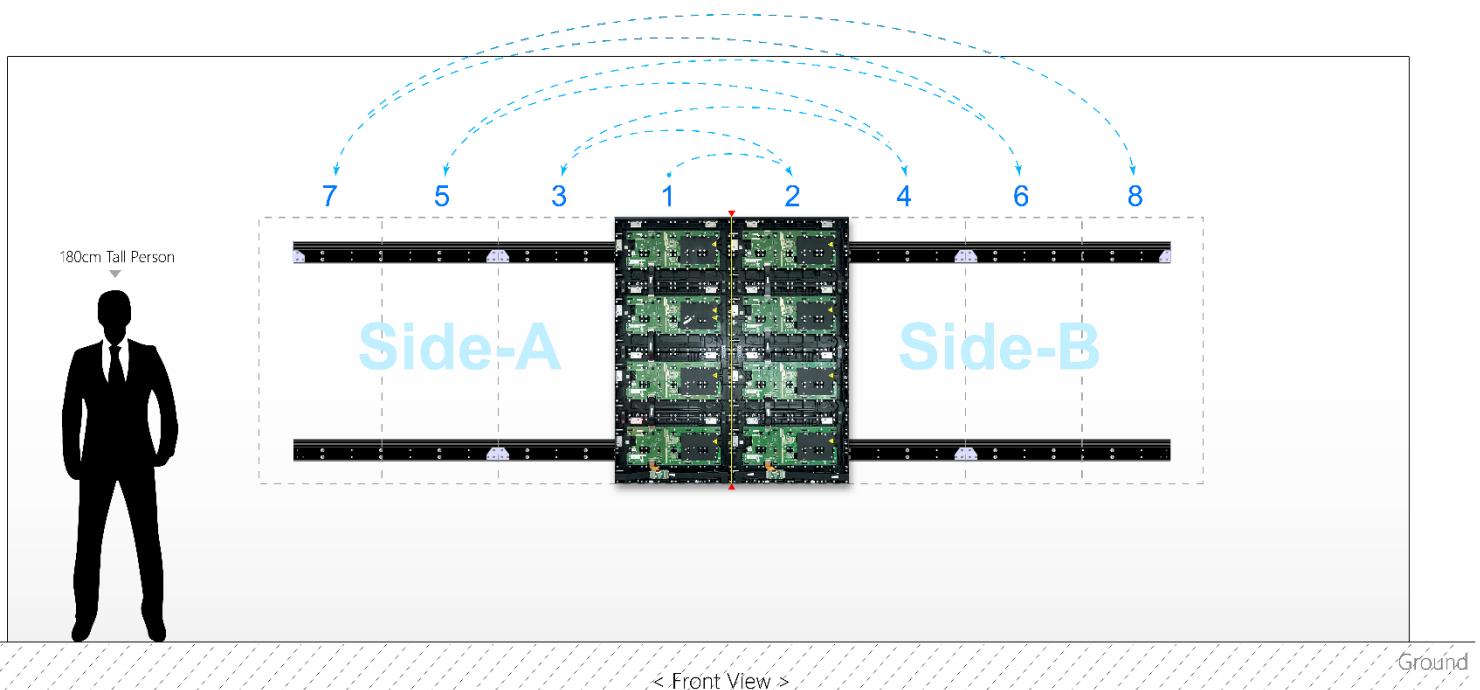
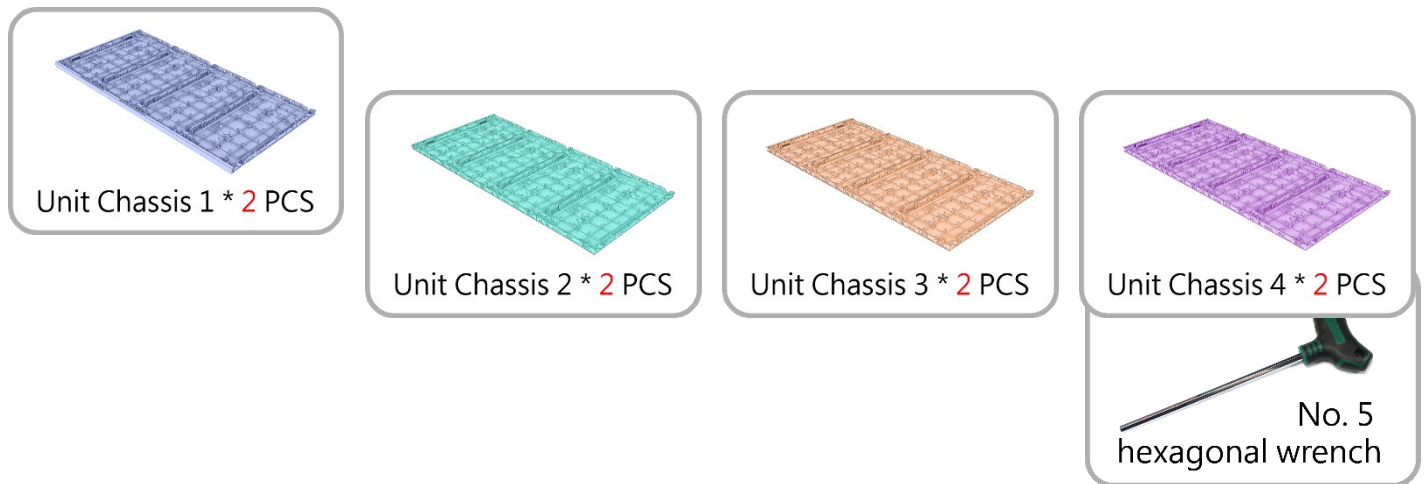

- Assembly sequence diagram of the Unit Chassis for the UWC196 Ultra-Wide LED display.

Step 5 : Assemble the whole

- 1) Hang the unit chassis from the middle to the sides, and hang the wall mount on the cabinet on the wall mount on the floor stand;
- 2) Install the adjacent second column of unit chassis, making the hooks hang on the wall mounts, while the adjacent sides are tightly aligned. Pull out the side spring locating pin, insert the locating pin completely into the corresponding locating hole, and then rotate the side hook lock with a corresponding allen wrench to completely lock the two columns of unit chassis, as shown in the figure below :

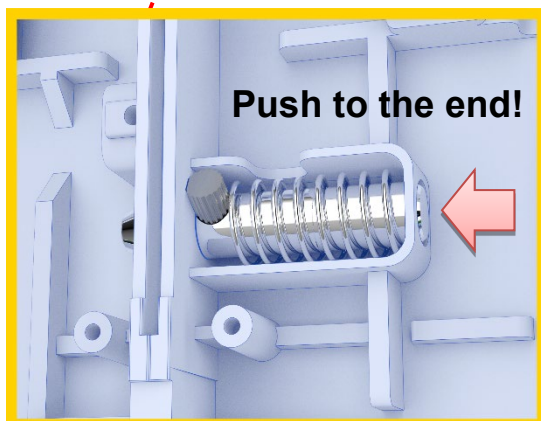
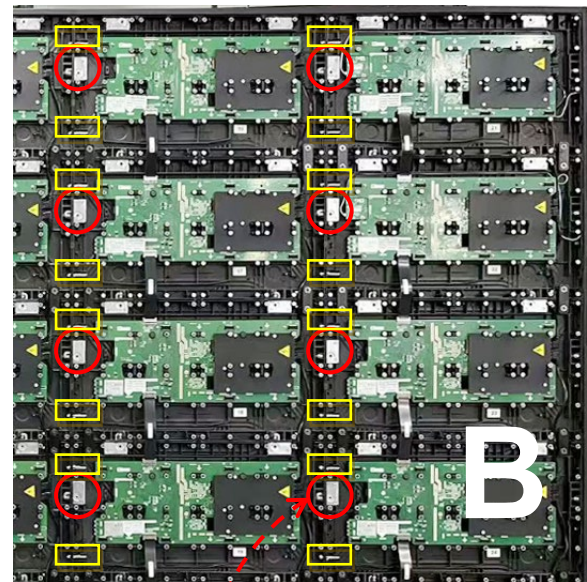
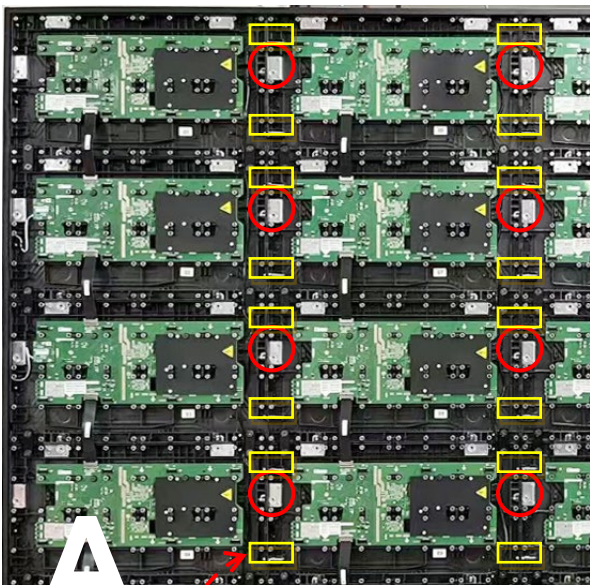

- Location pin * 56 PCS

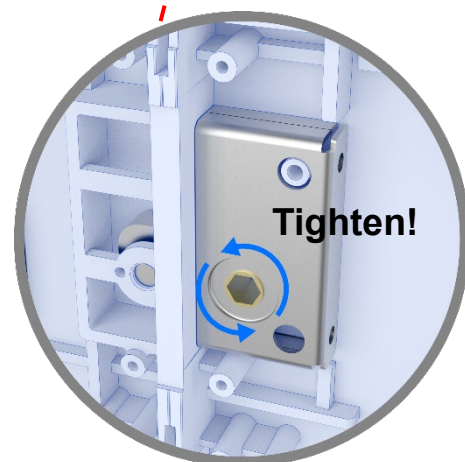

- Side hook * 28 PCS

1) Complete the installation of the other columns of unit chassis in order, as shown in the figure below :

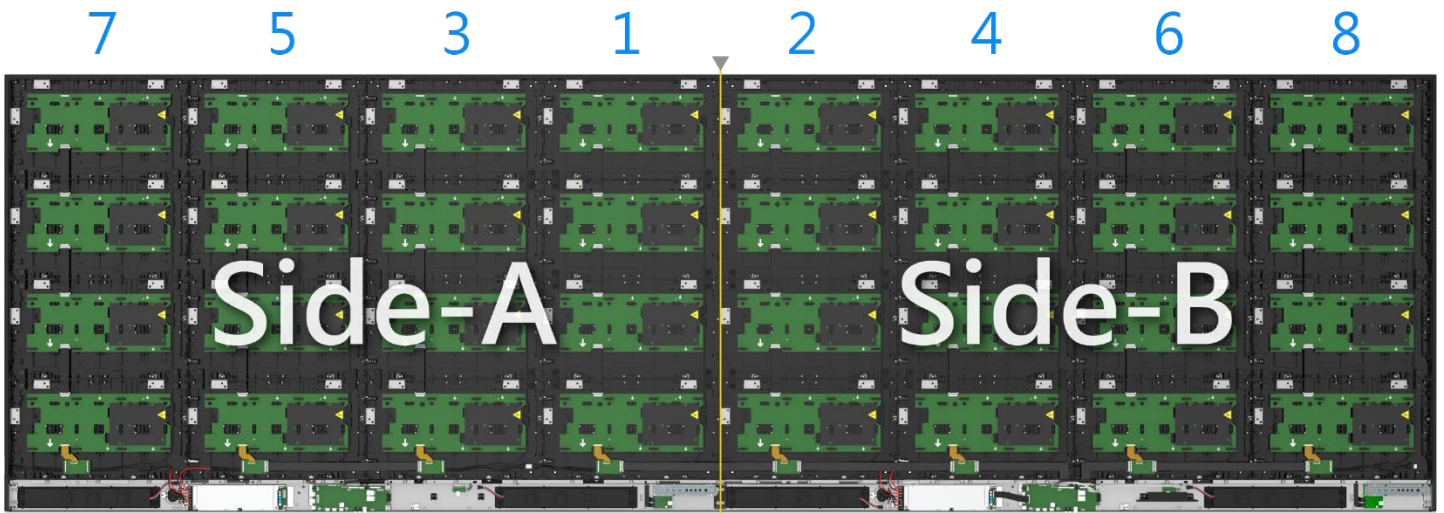

- Completed assembly of all Side-A & Side-B LED display Unit chassis.

Step 5 : Assemble the Bottom Frames

Since the Bottom Frames assembly process is the same for both Side-A & Side-B displays, only one example will be shown.

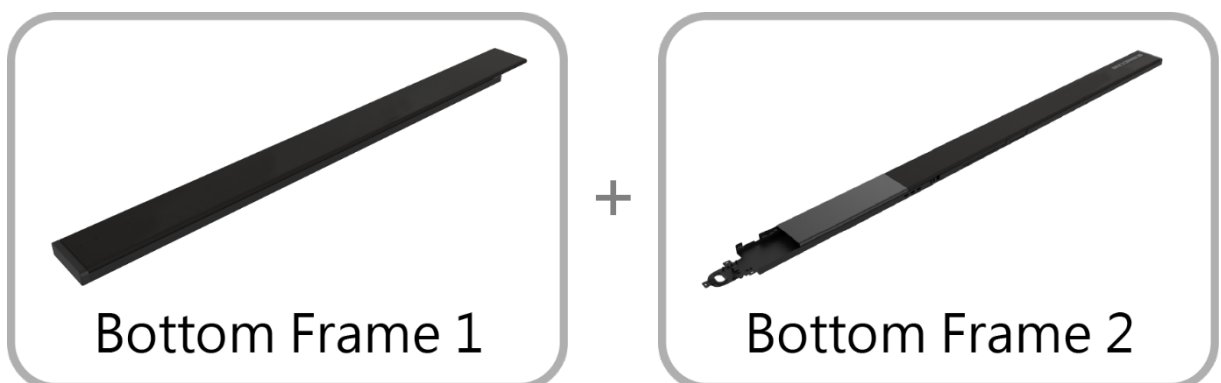

- 1) The bottom frame assembly is composed of bottom frames 1 and 2, connected by the built-in connecting plate for the bottom frame, as shown in the figure :

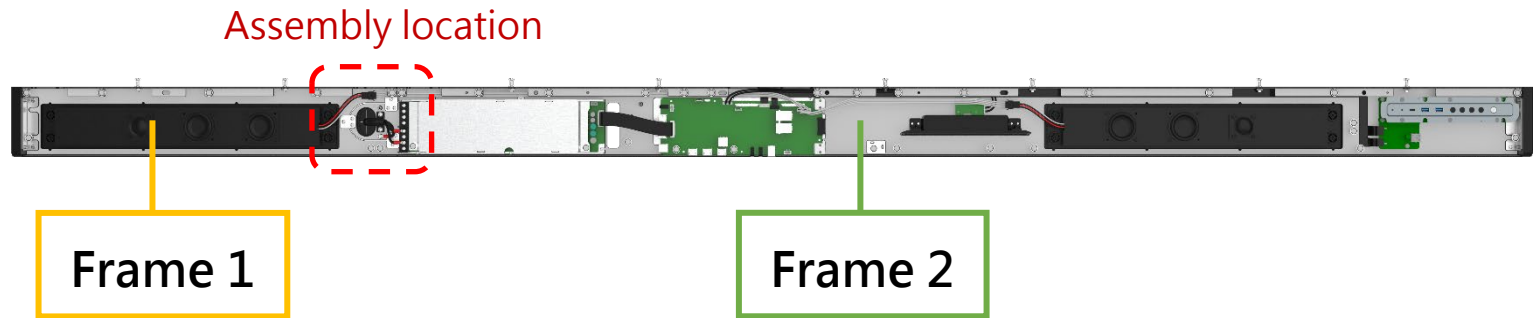

- This is a schematic diagram showing the component positions that make up the display bottom frame. The areas marked with red dashed lines indicate the assembly locations.

- 2) Use the three connector plates included with Bottom Frame 2 to join the Bottom Frame 1 and Bottom Frame 2 modules. Secure them together using three **M3 screws**.

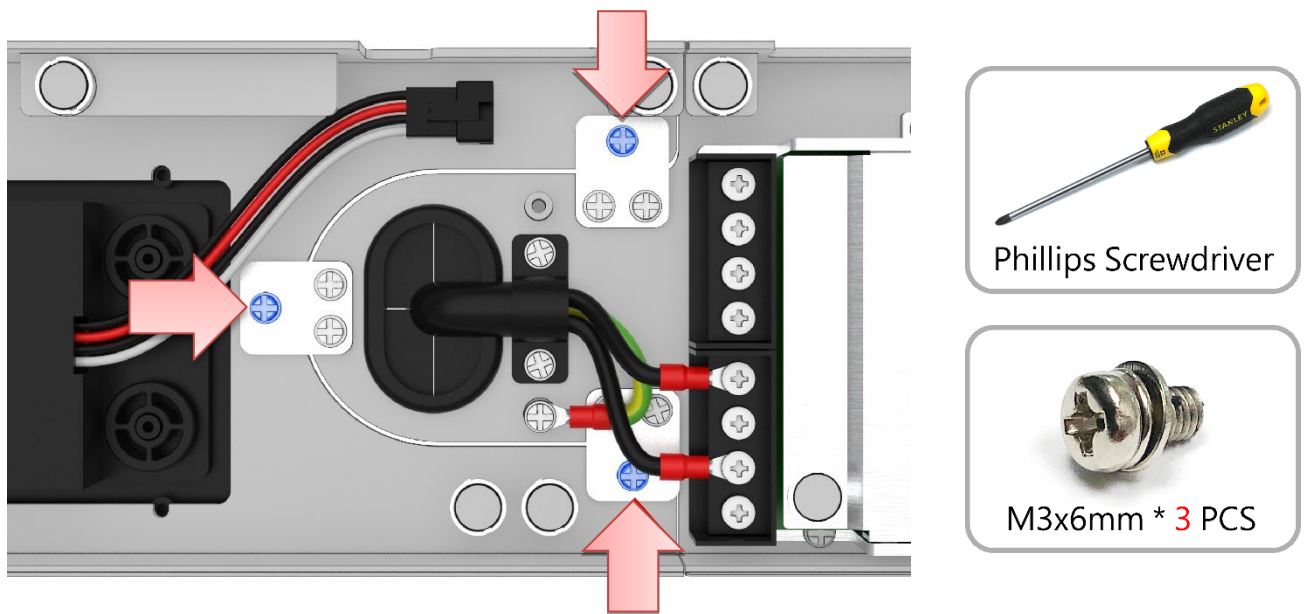

- The bottom frame assembly position detail view.

- 3) Next, we will attach the two bottom frame bar to the Side-A and Side-B display units, combining them into a single assembly. The SIDE-A and SIDE-B LED displays each have **8 locking pins** on the bottom frame for connecting to the screen body. Their positions are indicated by the red circles in the image below.

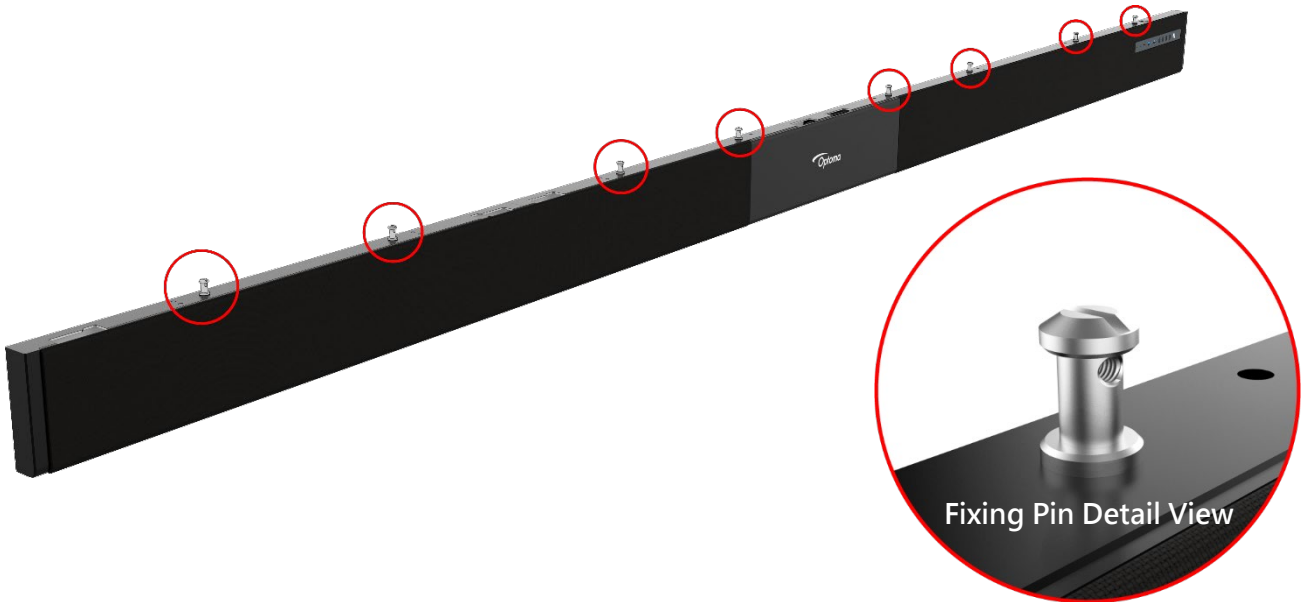

The following is the installation guide for the UW196 Ultra-wide LED display bottom frame. First, we demonstrate the key points for installing the bottom frame of the SIDE-B display, as described below :

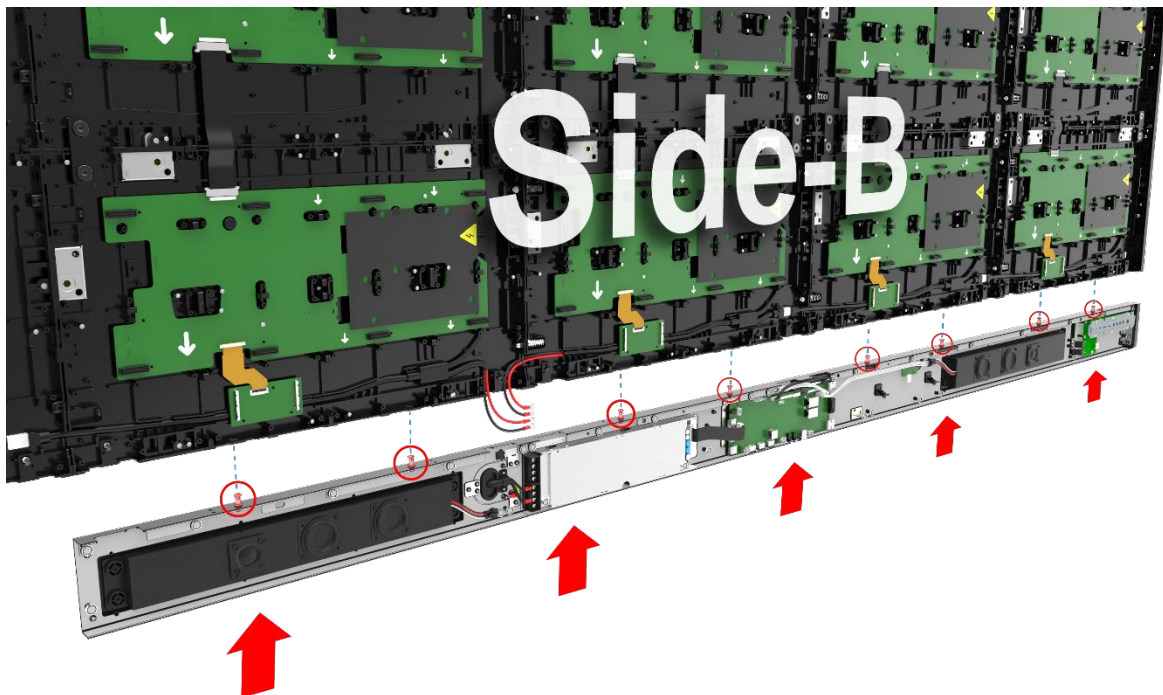

- As shown in the figure, align and insert the **8 lock pins** on the top of the bottom frame into the mating holes at the bottom of the Side-B display.

The bottom frame is fixed to the cabinet assembly with locking blocks and retaining screws (insert the locking block first and then drive in the screws to fix), as shown in the figure below :

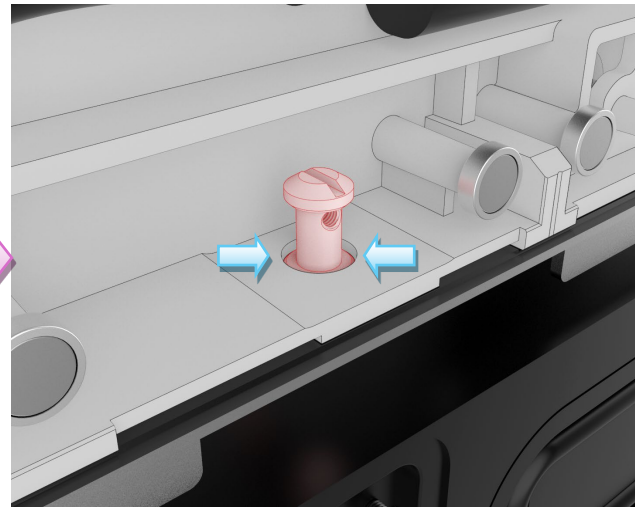
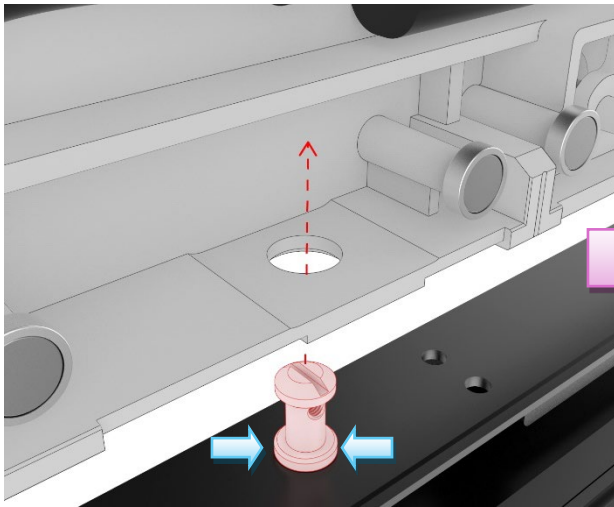

- When installing the lock pins into the corresponding mounting holes on the display, make sure that the base of the pin indicated by the blue arrow symbol is fully recessed into the hole.

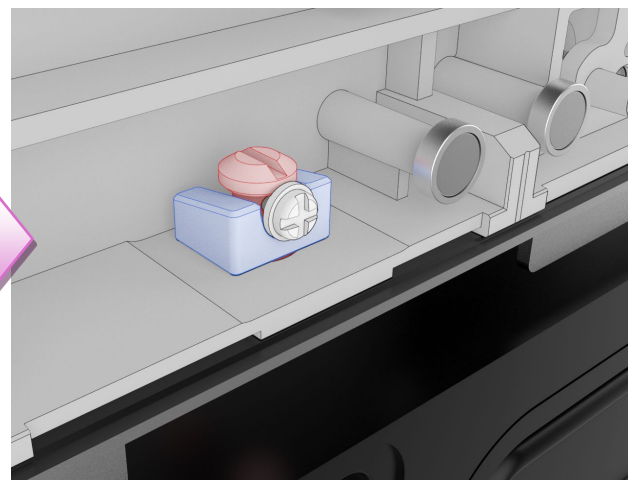
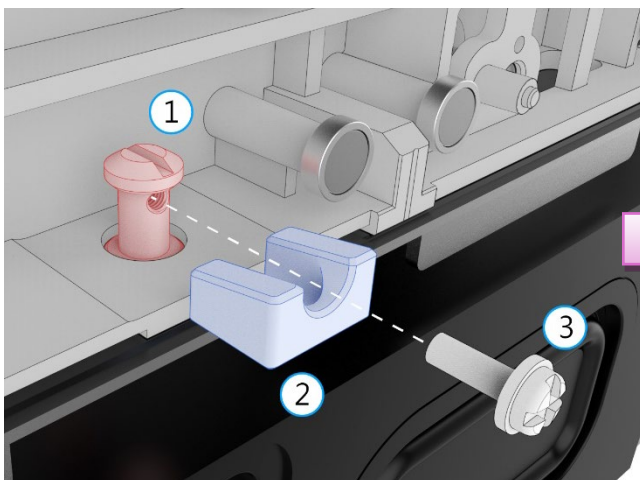

- In the illustration, part number 1 is the lock pin, part number 2 is the lock block, and part number 3 is an M3 screw used to prevent the lock block from coming loose or separating.

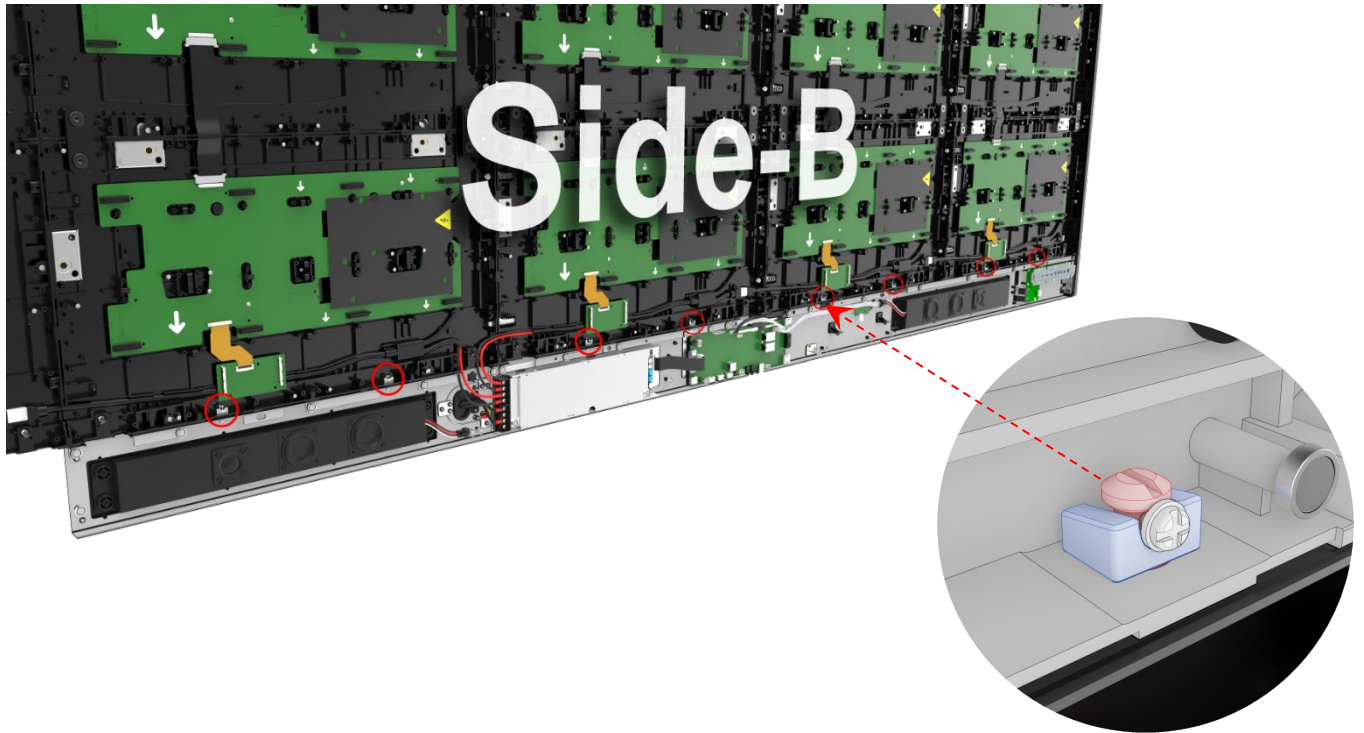

- The appearance of the Side-B with the bottom frame assembled.

The method for assembling the Side-A display bottom frame is the same as that for the Side-B display.

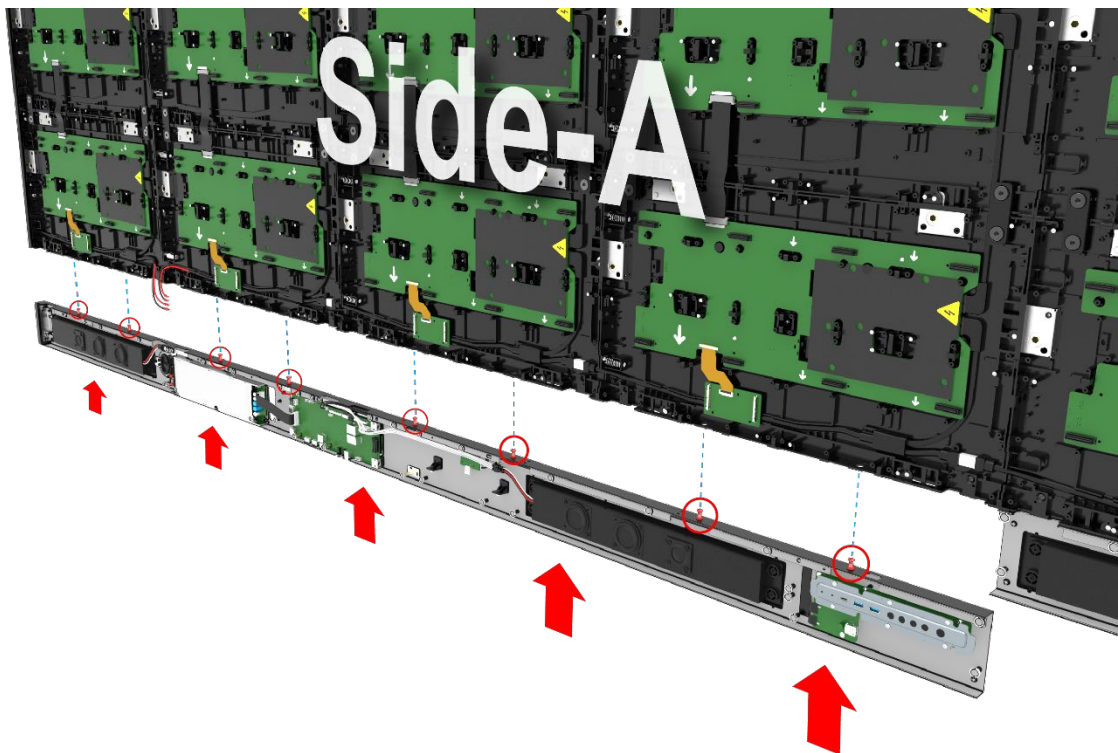

- As shown in the figure, align and insert the 8 lock pins on the top of the bottom frame into the mating holes at the bottom of the Side-A display.

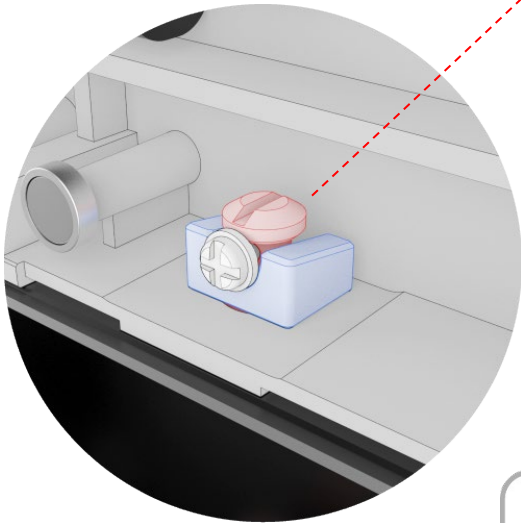
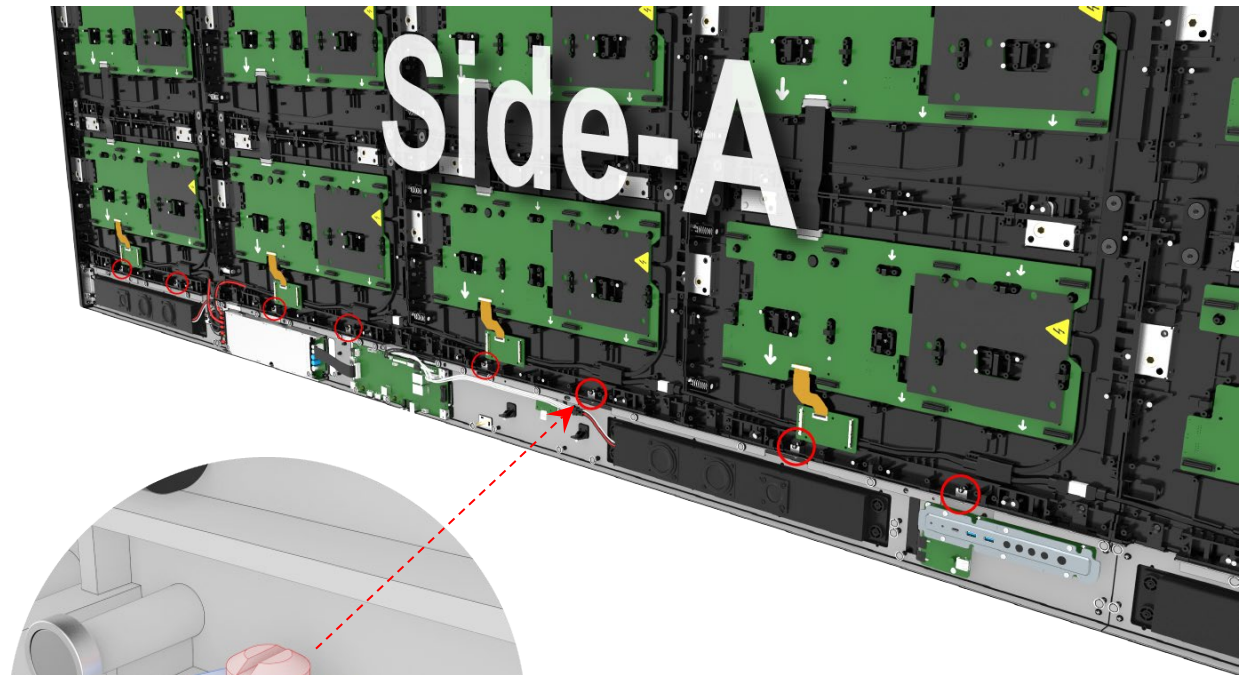

- The bottom frame of the Side5-A display is also secured using lock blocks and M3 screws to fasten 8 lock pins.

4) Next, position the system bar connection plate at the red-marked area in the diagram. Secure it using **four M3*6mm screws** to join the bottom frames of Side-A and Side-B into a unified structure. The position indicated by the arrow symbol denotes the locking screw location.

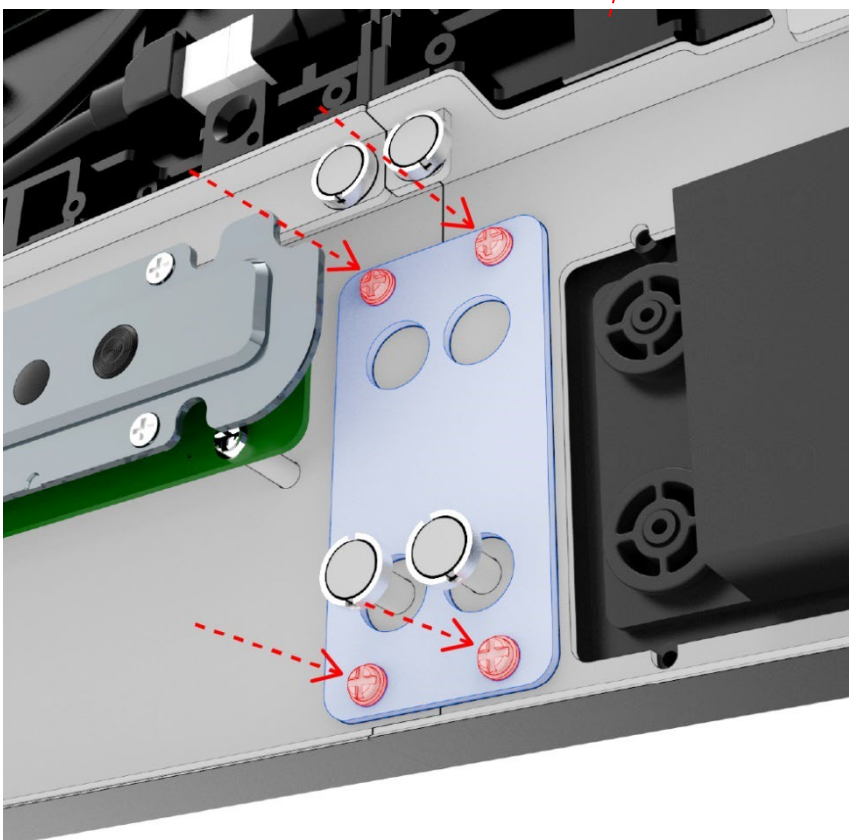
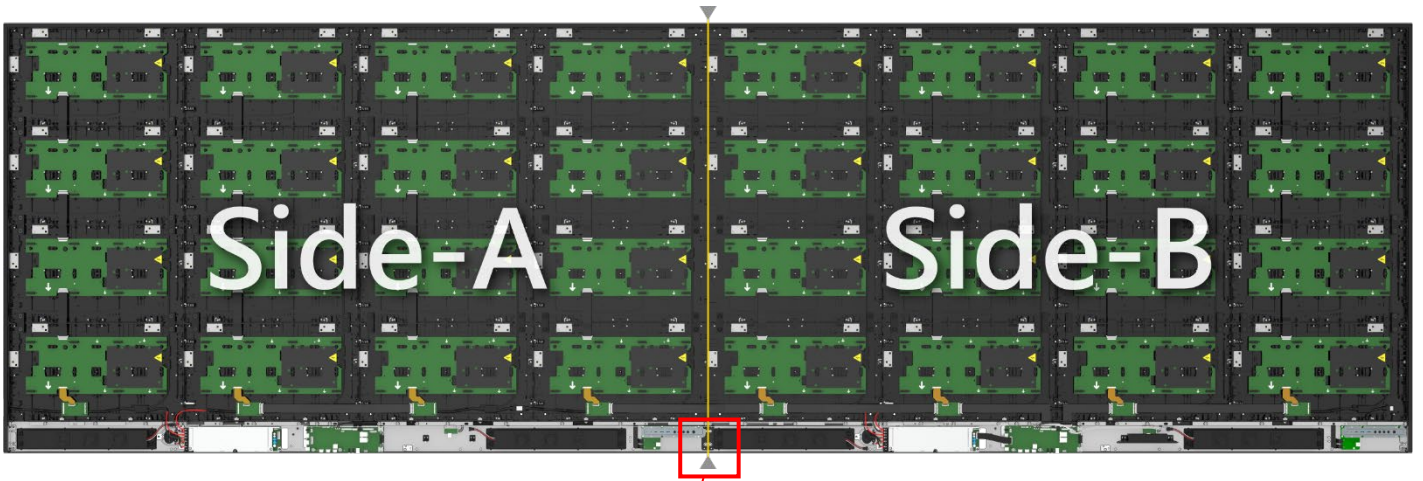

Step 6 : Cable routing

A There are two tasks involved in setting up cable routing for UWC196 LED display:

1. Removing unused cables
2. Connect the cables used for UWC196 LED display.

Below is the list of unused cables to be removed, including their model numbers, quantities, and positions :

1. Removing unused cables

- A. Remove the Side-A display speaker cable.

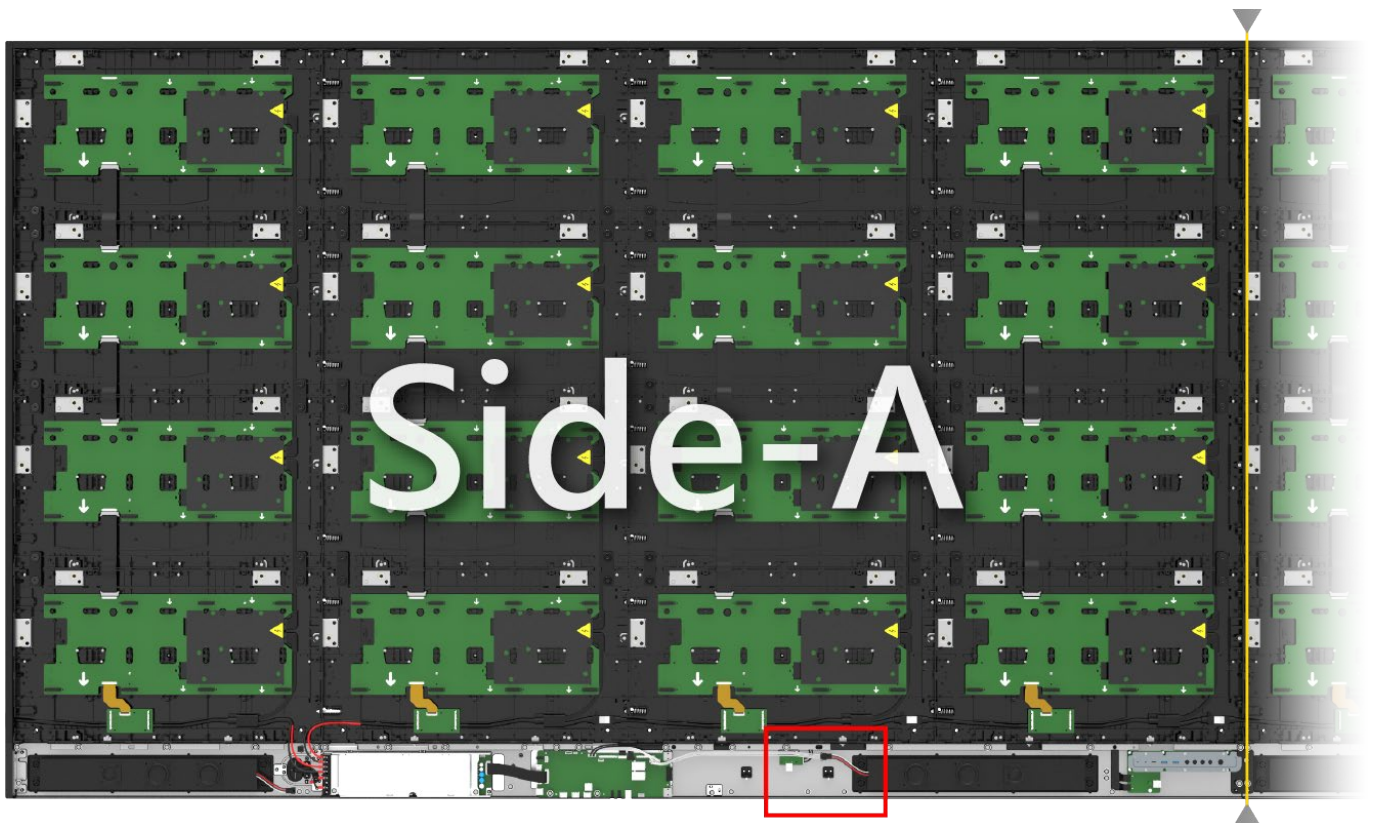

- The red-framed mark in the diagram highlights the specific location on the Side-A display where the speaker cable is to be removed.

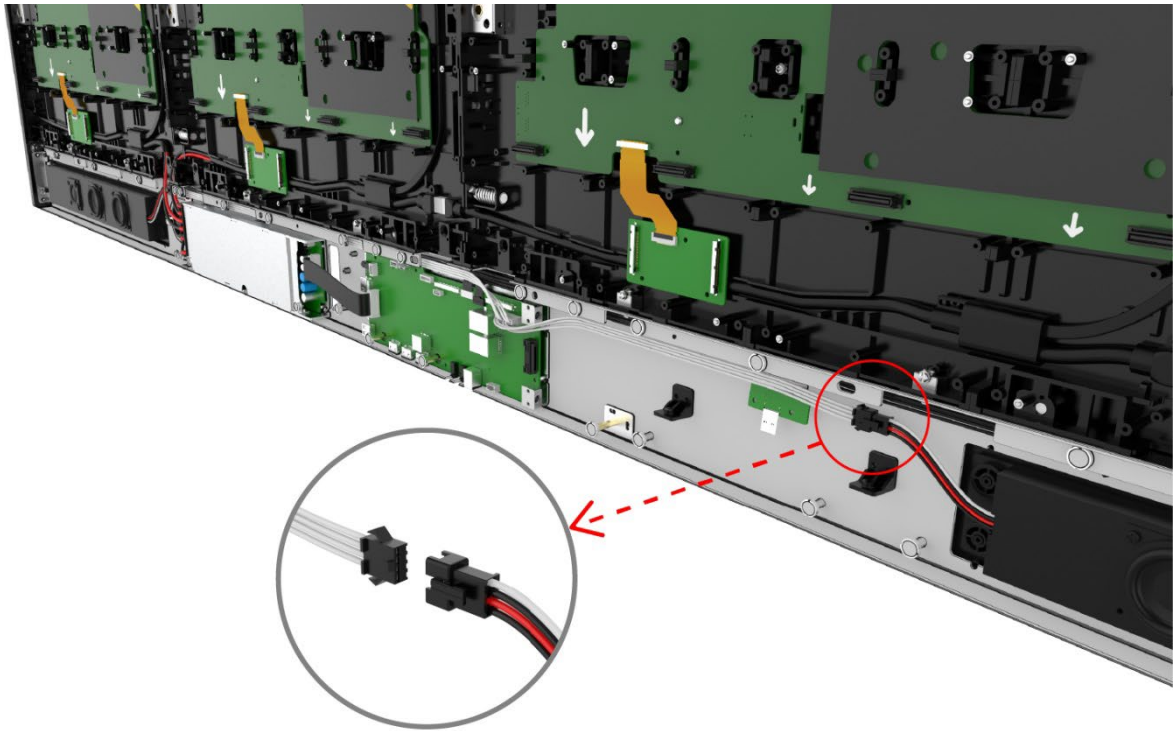

- Step 1 : Disconnect the speaker cable connector at the red-circled location, as shown in the diagram.

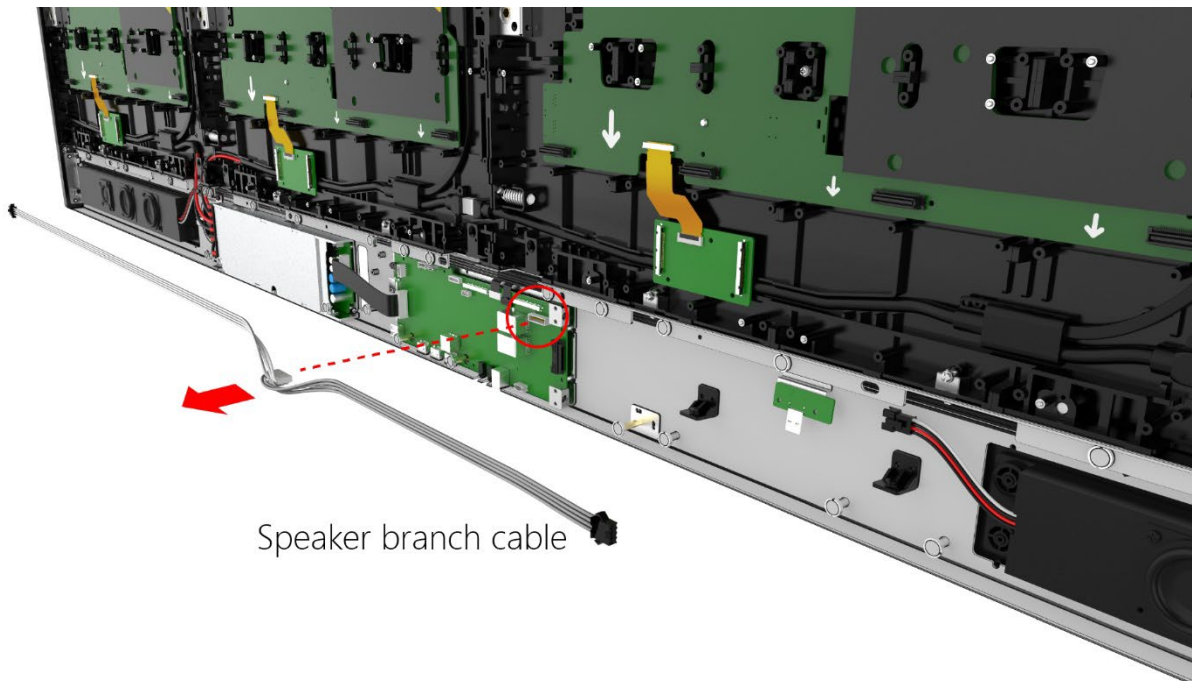

- Step 2: Following the direction indicated by the arrow, carefully detach the speaker branch cable from the system board and retain it for future use.

B. Remove the power cable from the system board.

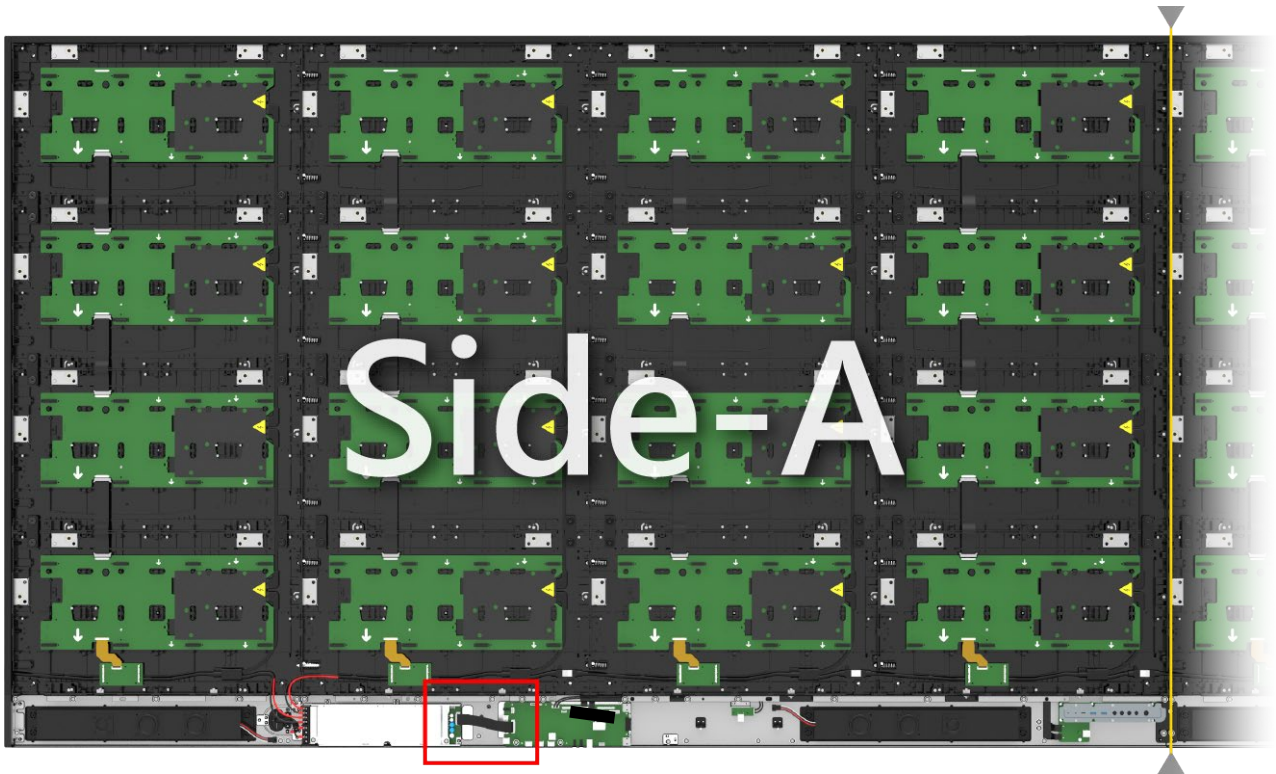

- The area marked with a red box in the illustration shows the location of the power cable to be disconnected.

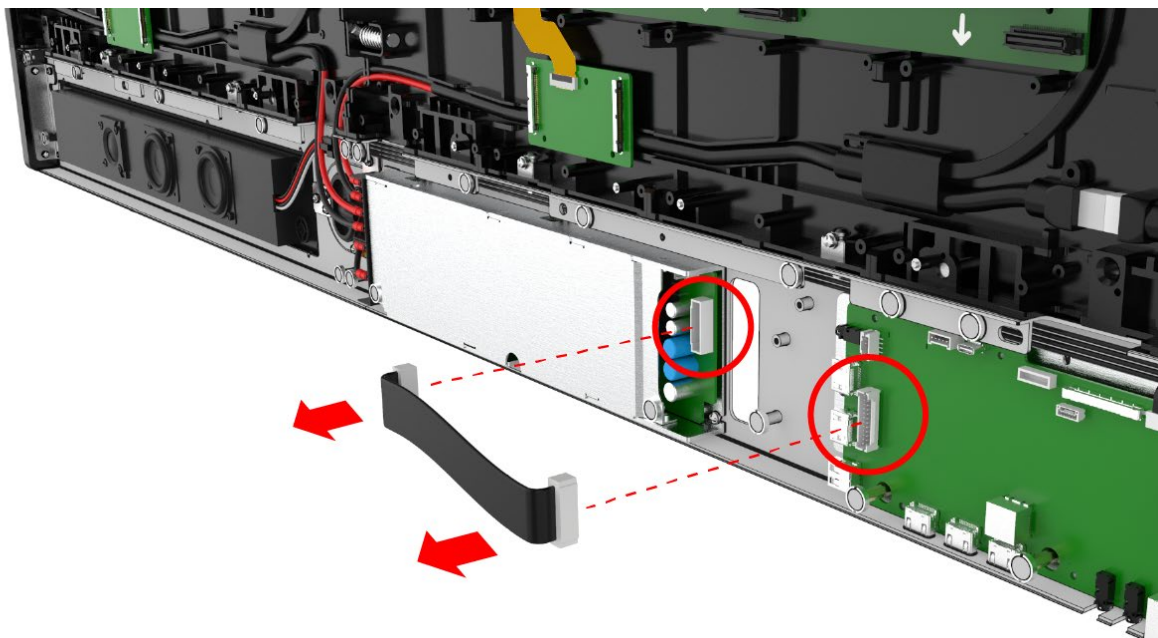

- Please refer to the illustration and disconnect the power cable connecting the PSU and the system board. Make sure to store it properly.

2. Connect the cables used for UWC196 LED display.

A. Connect the power cable to the Power Supply Unit (PSU).



- The positions marked with red circles in the diagram show the two installation points for the PSU power cables.



Phillips Screwdriver

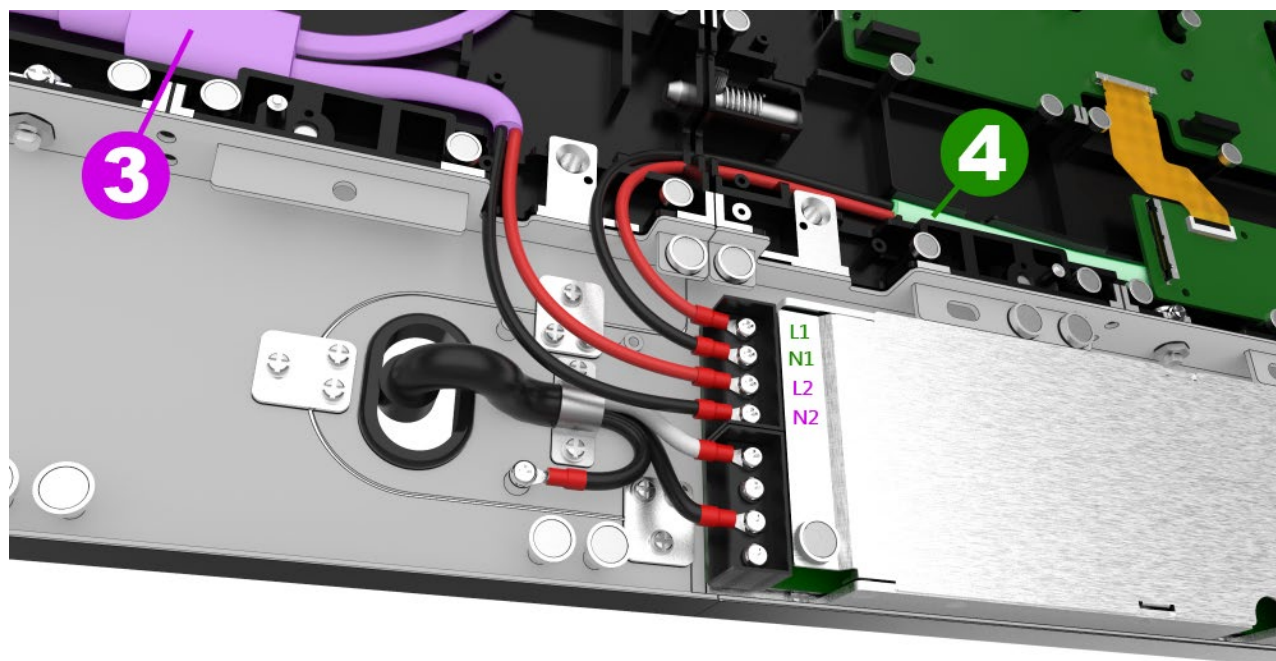

- Secure the ring terminals of the red and black cables split from power cable No. 3 to the L2 and N2 terminals on the PSU, and secure the ring terminals of the red and black cables from power cable No. 4 to the L1 and N1 terminals on the PSU.

B. Install the PSU synchronization signal cable

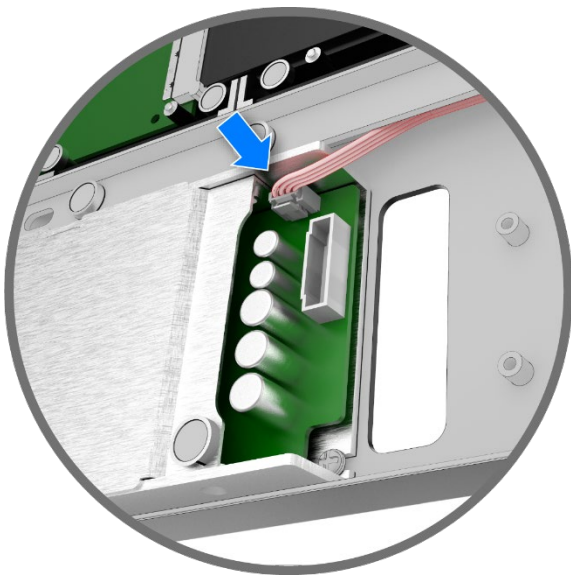
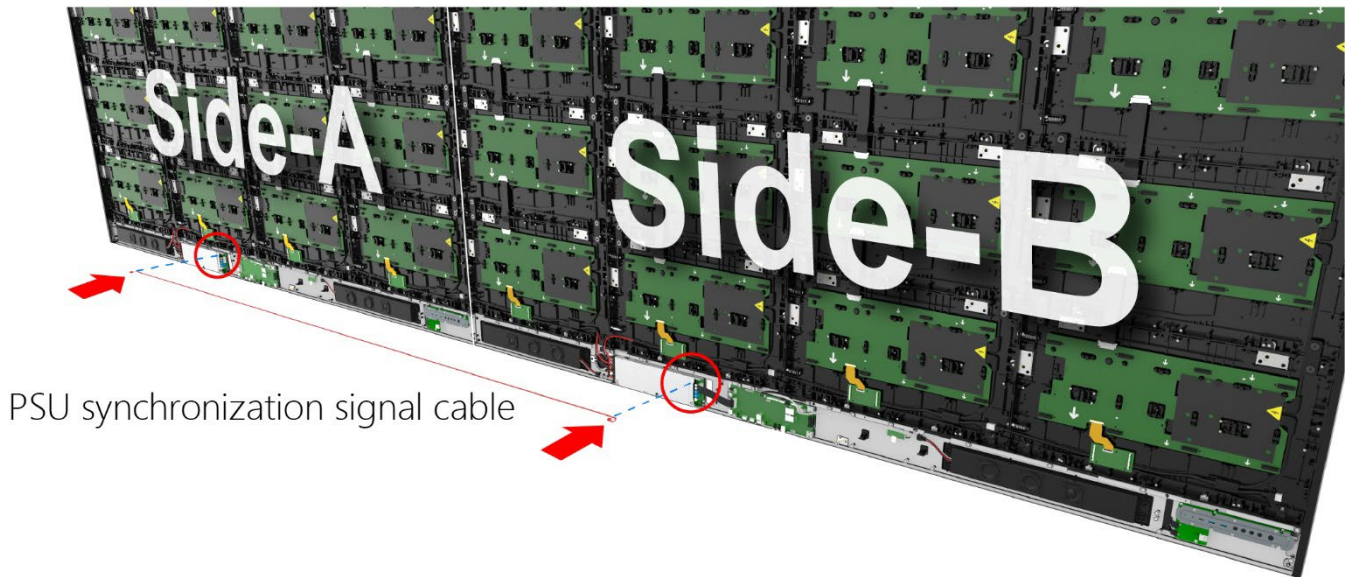
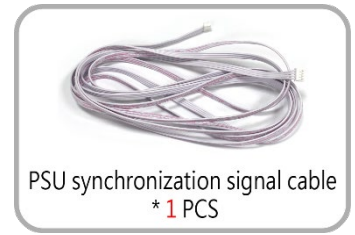

- The image above shows the PSU detail view inside the Side-A bottom frame. Please connect one end of the PSU synchronization signal cable to the PSU port indicated by the blue arrow symbol.

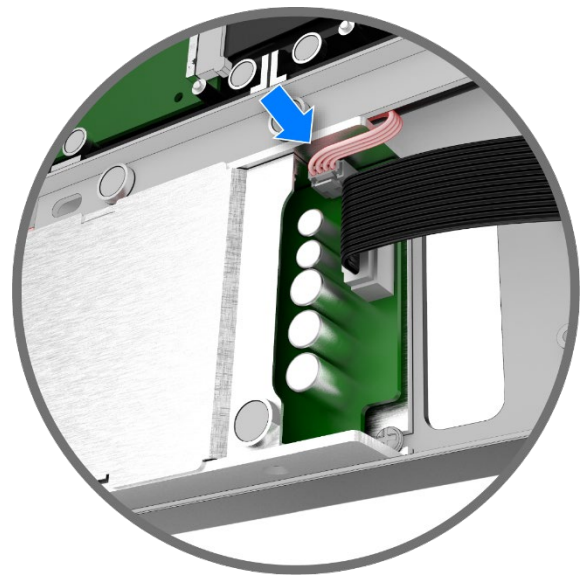

- The image above shows the PSU detail view inside the Side-B bottom frame. Please connect one end of the PSU synchronization signal cable to the PSU port indicated by the blue arrow symbol.

Wiring Recommendations for PSU Synchronization Signal Cables

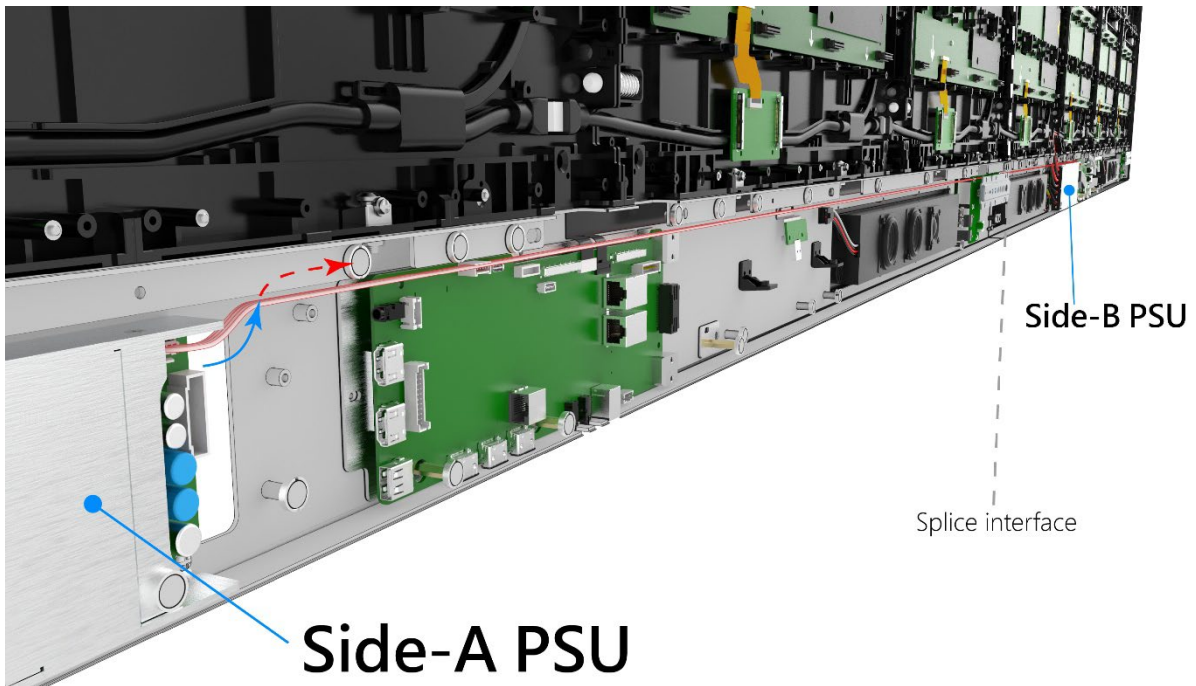

- The figure above shows the wiring layout of the PSU synchronization signal cable. Routing this cable through the upper inner channel of the system bar to connect the PSUs of the [Side-A](#) and [Side-B](#) LED displays.

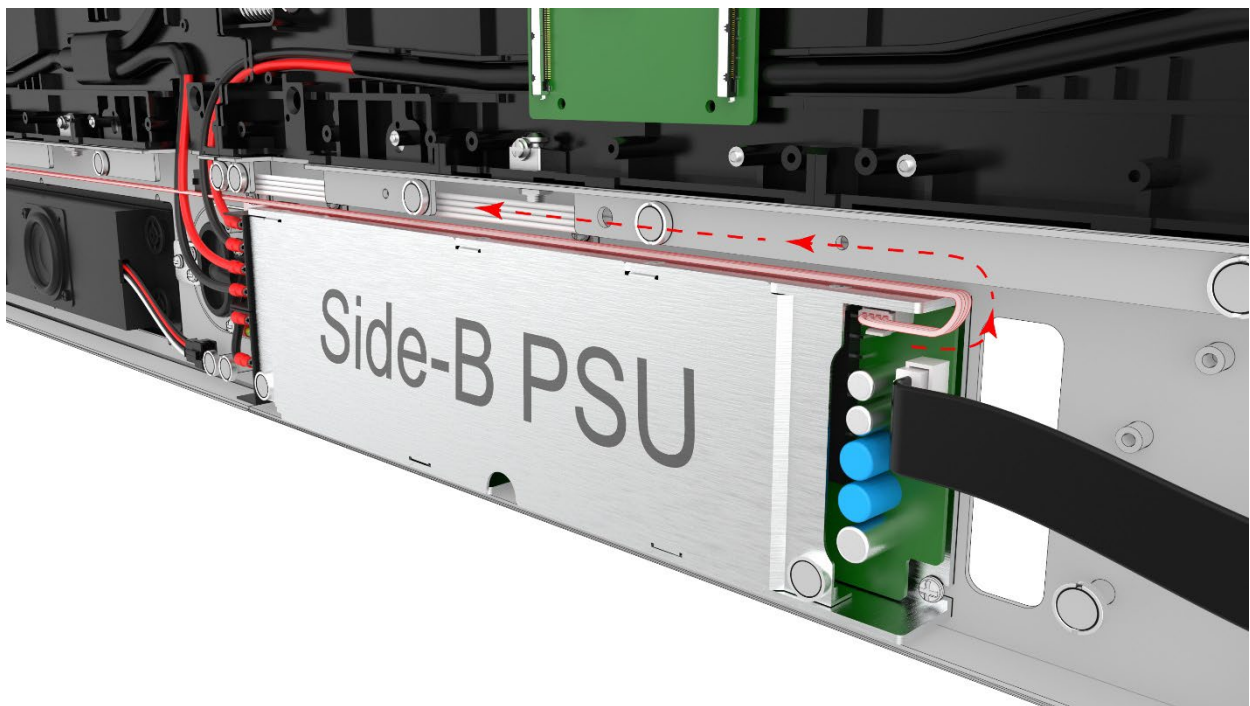

- This is a detailed view of the PSU synchronization signal cable connection for the [Side-B](#) LED display, clearly showing the precise wiring position.

C. Install the Speaker extension cable

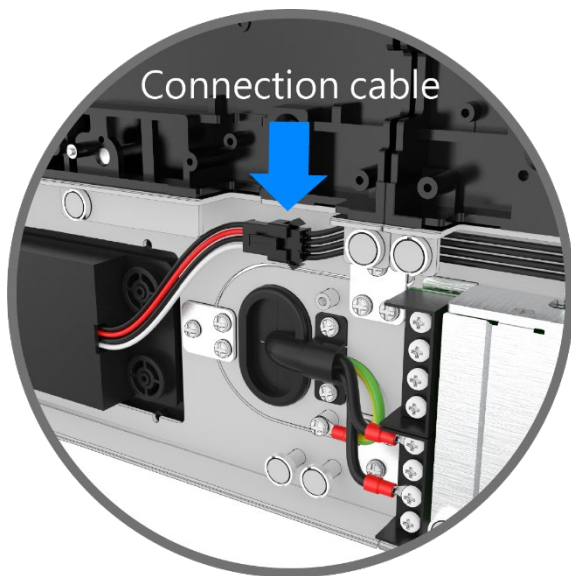
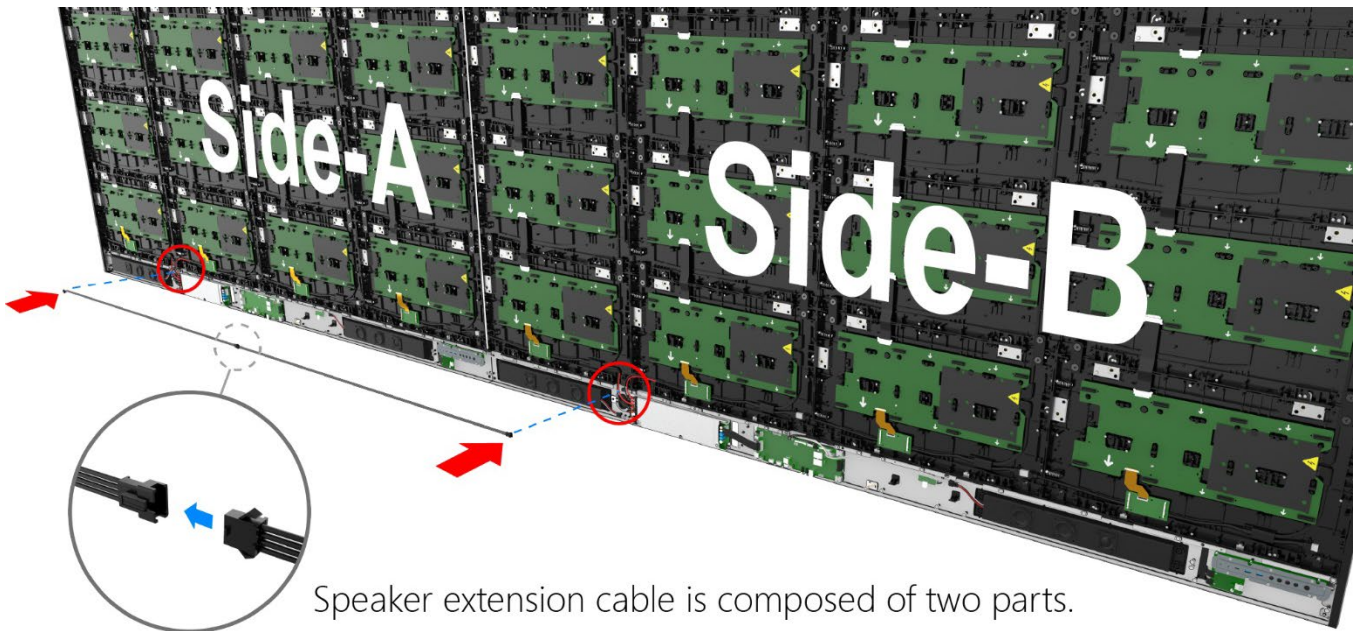
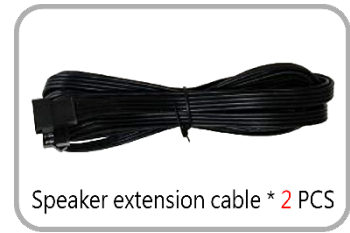

- The image above shows the detail view of the right-side speaker inside the Side-A bottom frame. Please connect one end of the speaker extension cable to the speaker cable port indicated by the blue arrow symbol.

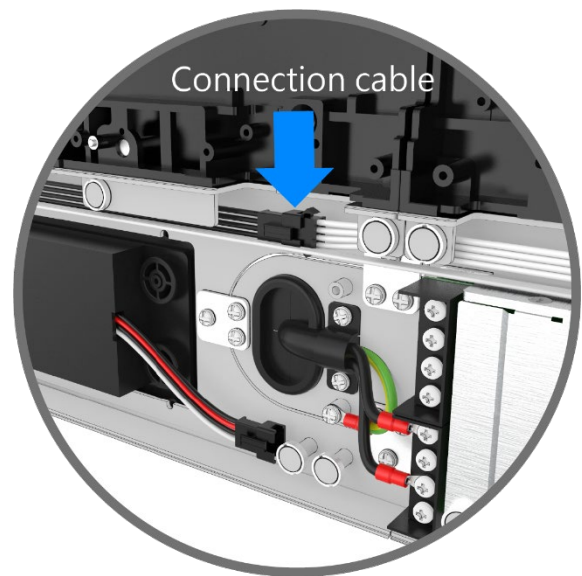

- The image above shows the detail view of the left-side speaker inside the Side-B bottom frame. Please connect one end of the speaker extension cable to the speaker cable port indicated by the blue arrow symbol.

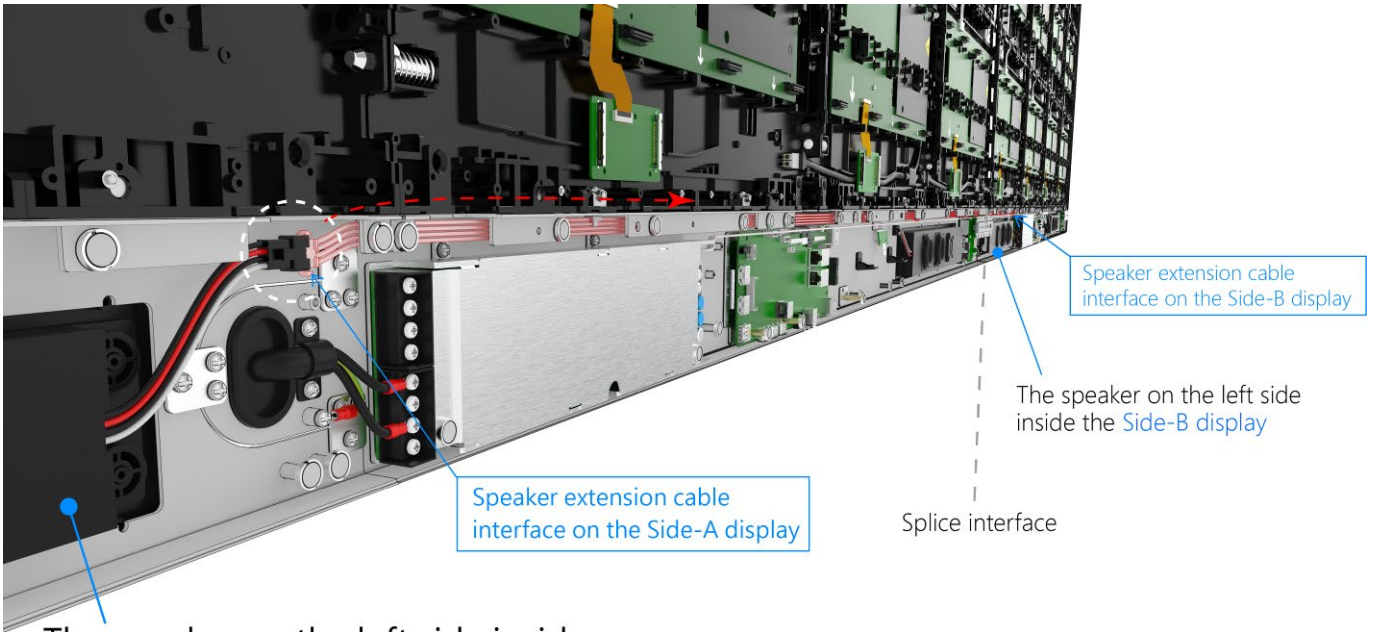

The speaker on the left side inside the **Side-A** display

- The above diagram shows the routing of the speaker extension cable. Routing the cable through the inner groove on the top of the system bar, connecting to the left-side speakers inside the **Side-A** and **Side-B** system bars.

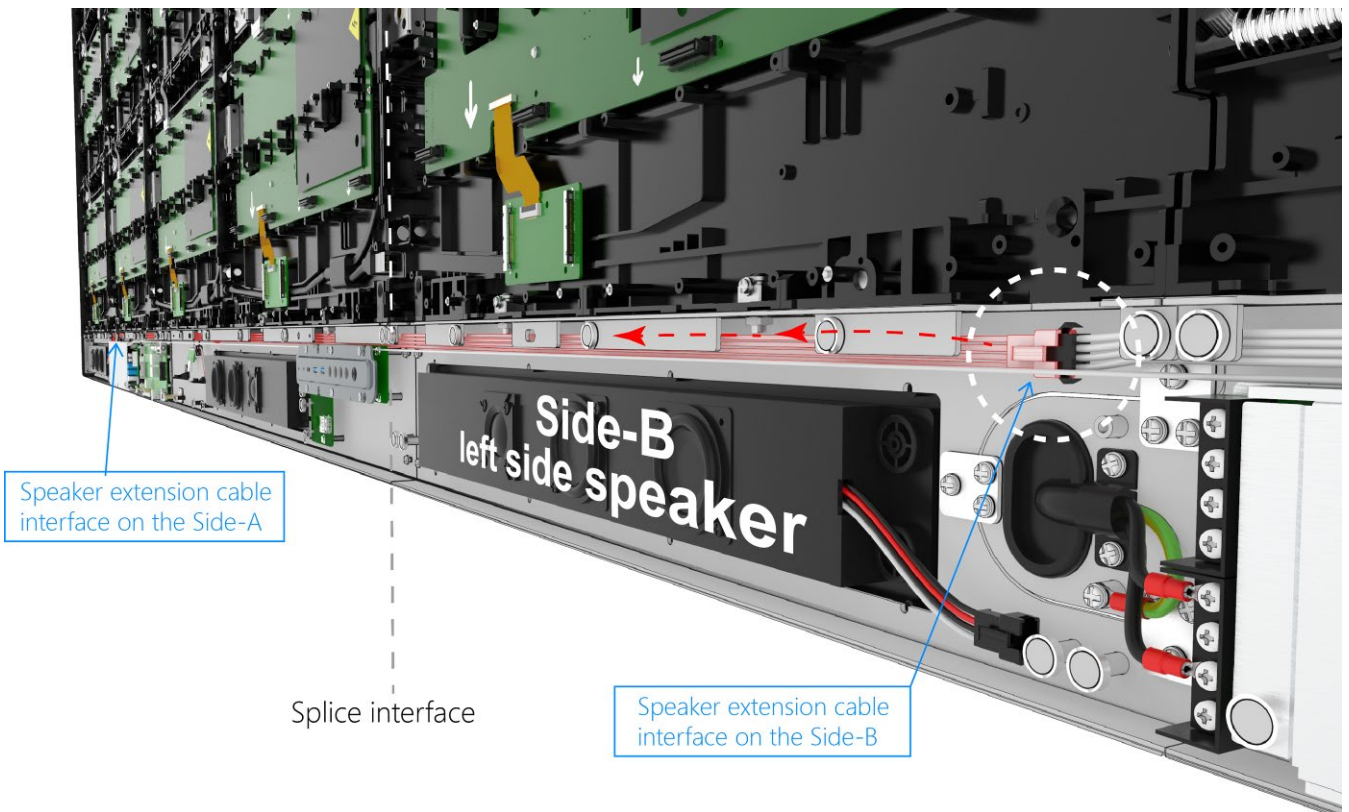

- This is a detailed view of the left-side speaker inside the **Side-B** system bar, showing its connection to the speaker extension cable and clearly indicating the precise routing position.

D. Install the FFC cable

To assemble a dual UW196 Ultra-wide LED display, it is necessary to install four types of FFC cables. The installation positions and quantities for each type of FFC cable are described as follows:

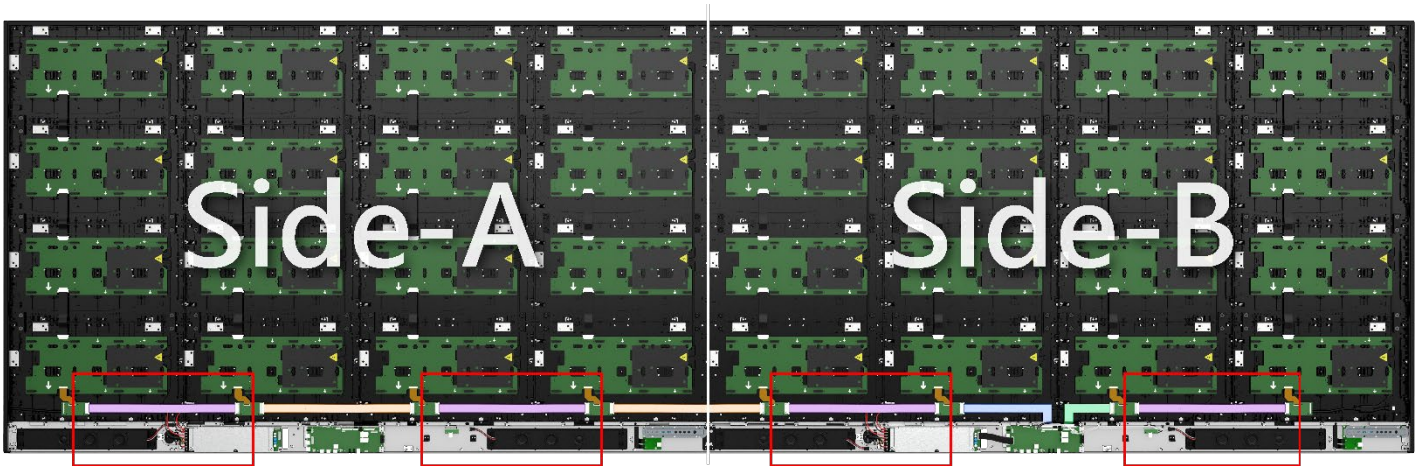

- Please take four FFC cables included with the Side-A and Side-B units and install them at the positions marked with red boxes in the image. Connect both ends of each cable to the corresponding ports on the sender boards of each unit chassis.

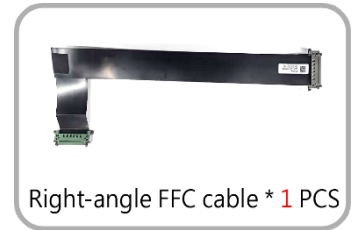
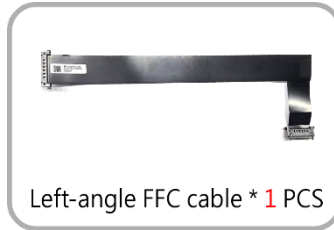

- As shown in the image, install **one Left-angle FFC cable** and **one Right-angle FFC cable** at the positions marked with red boxes.

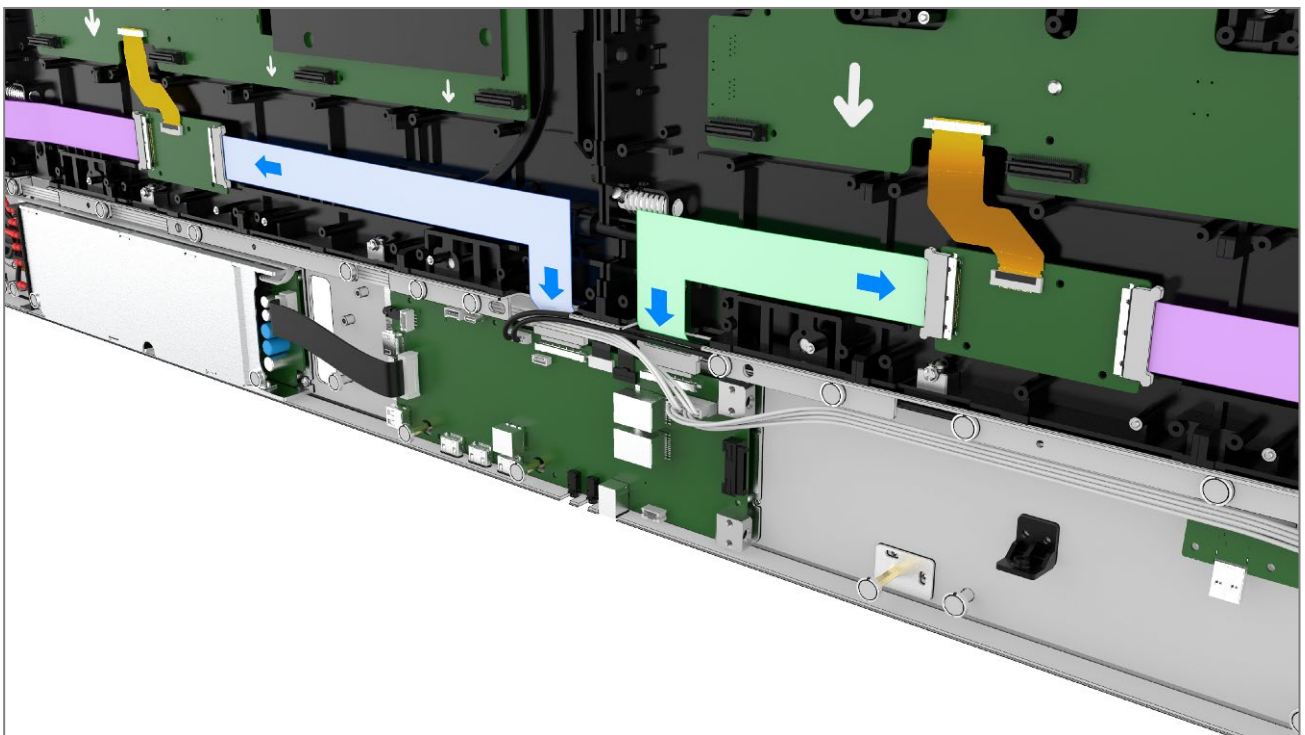

- This is the detail view of the FFC cable installation at the positions marked with red boxes. Please connect both ends of the FFC cable to the PCBA ports indicated by the blue arrow symbols.

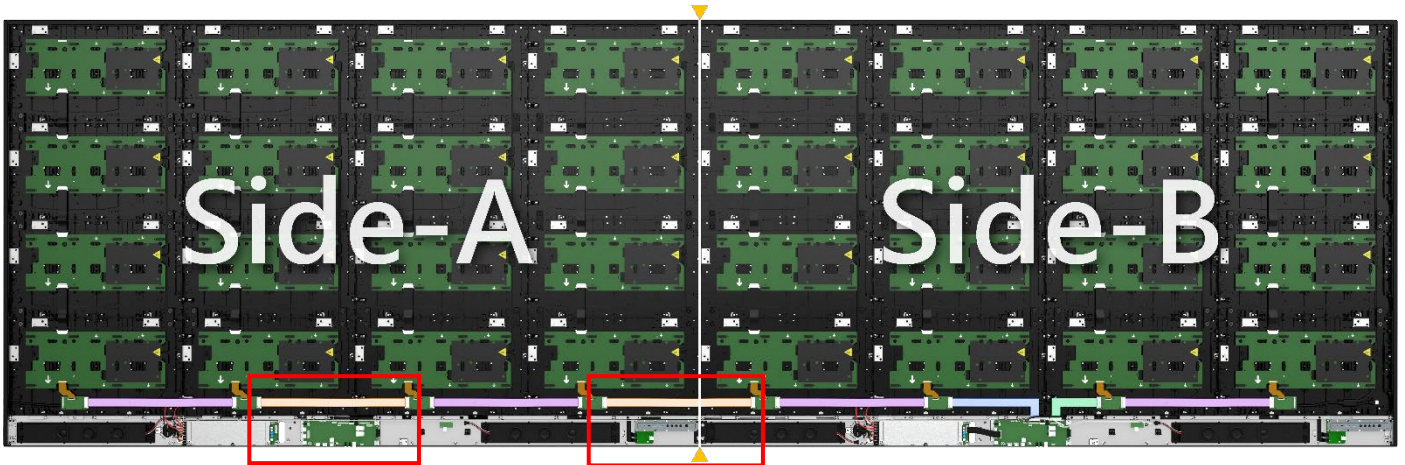

- Finally, install the two FCC cables at the positions marked with red boxes in the image.

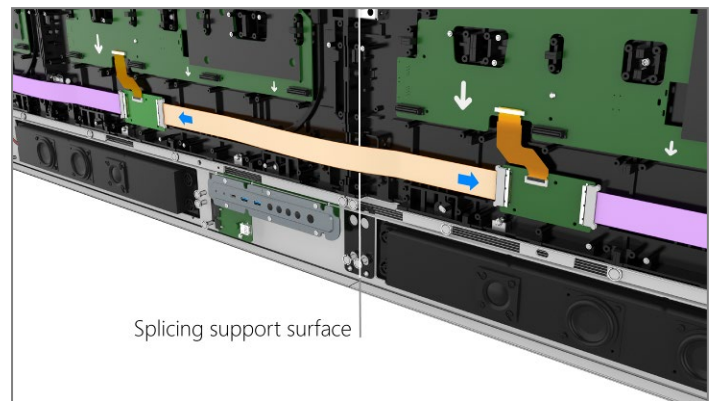
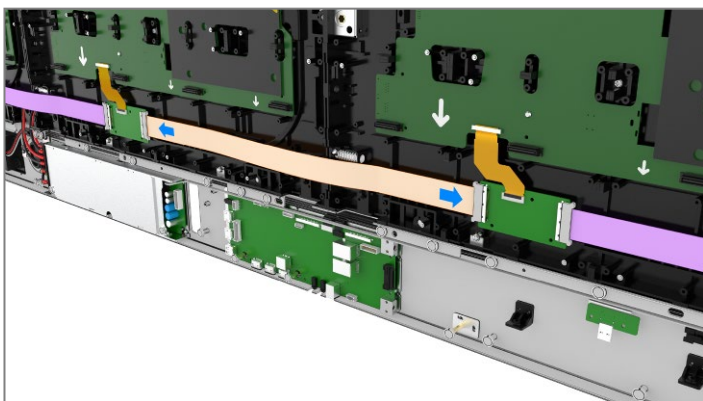

- This is the detail view of the installation positions for the two FCC cables. Please connect both ends of the cables to the PCBA ports indicated by the arrow symbols.

E. Install the Wi-Fi module (optional accessory)

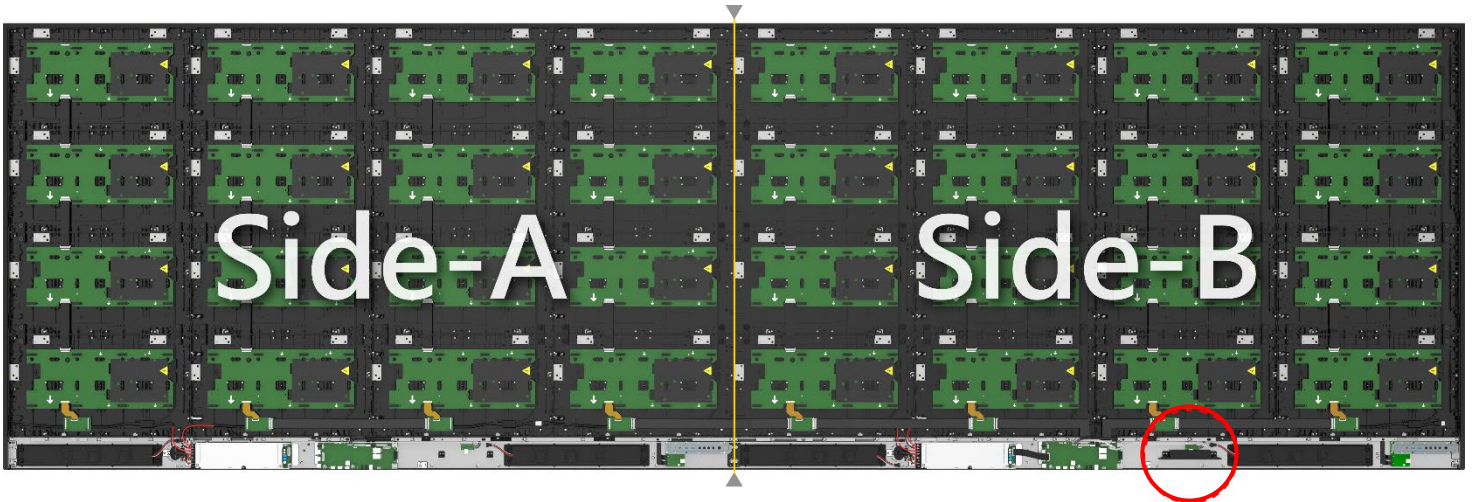

- The installation location of the Wi-Fi module for the UWC196 ultra-wide LED display is indicated by the red circle in the illustration.

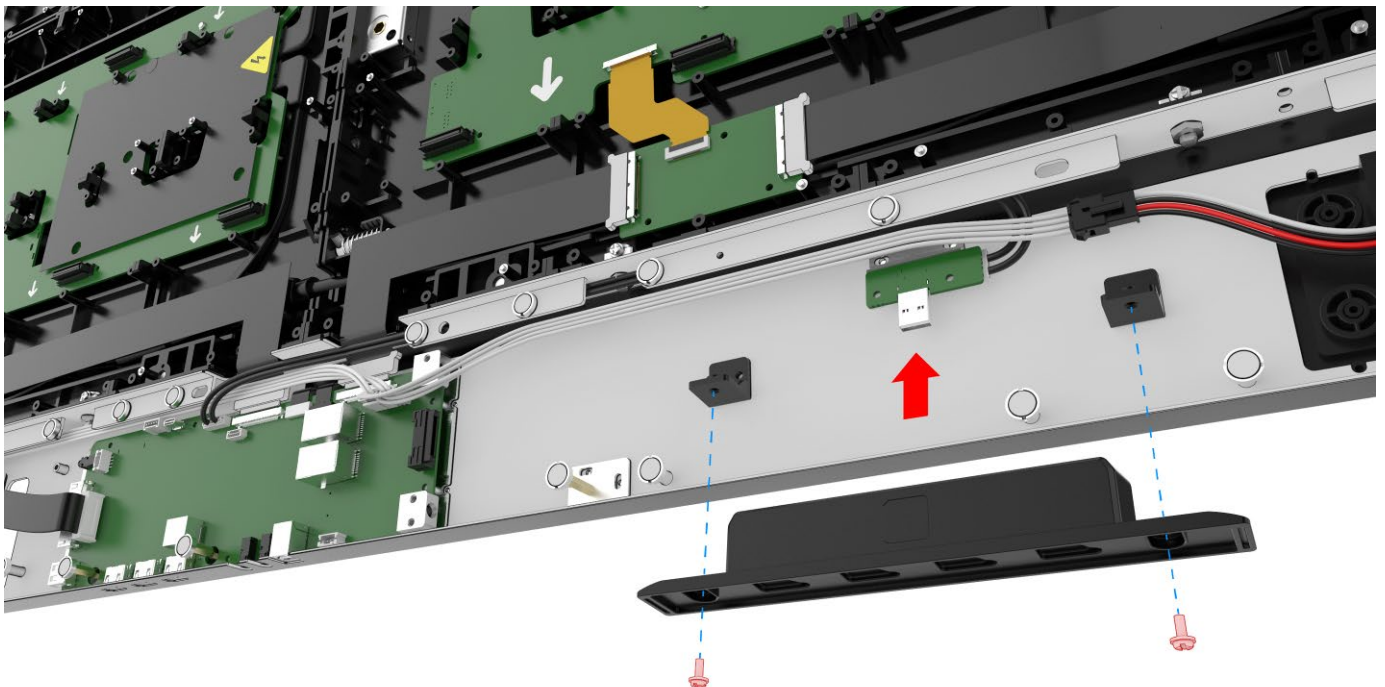

1. First, use a Phillips screwdriver to remove the two M3 screws pre-installed on the bracket.
2. Next, connect the Wi-Fi module interface to the USB plug of the LED display, then reinstall and tighten the two screws to secure them together as one unit.

-
- 6) Cabinet and LED panel serial number description, each shipped cabinet has a mark number in the top right corner (inside), this number represents the corresponding position of the cabinet when installed during factory calibration. Each LED panel (back) also has a mark number, such as : 16-5, where 16 represents the installation of this LED panel during factory calibration in cabinet 16, and 5 represents its position in cabinet 16.

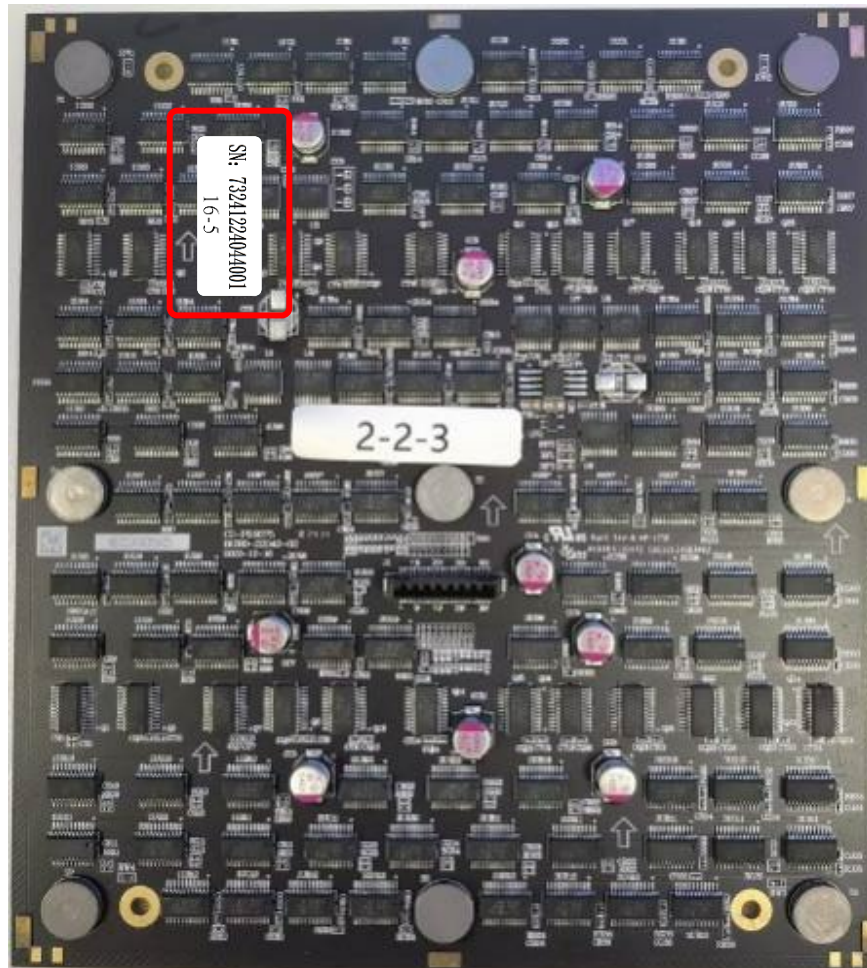

7) Each Ultra-Wide LED panel has a designated installation position. Installation personnel must check the panel ID number on the back of each LED panel and install it according to the positions shown in the LED panel location map for the two 108" LED displays that form the Ultra-Wide LED display.

			01#				05#				09#				13
1-1	1-2	1-3	1-4	5-1	5-2	5-3	5-4	9-1	9-2	9-3	9-4	13-1	13-2	13-3	13-4
1-5	1-6	1-7	1-8	5-5	5-6	5-7	5-8	9-5	9-6	9-7	9-8	13-5	13-6	13-7	13-8
			02#				06#				10#				14#
2-1	2-2	2-3	2-4	6-1	6-2	6-3	6-4	10-1	10-2	10-3	10-4	14-1	14-2	14-3	14-4
2-5	2-6	2-7	2-8	6-5	6-6	6-7	6-8	10-5	10-6	10-7	10-8	14-5	14-6	14-7	14-8
			03#				07#				11#				15#
3-1	3-2	3-3	3-4	7-1	7-2	7-3	7-4	11-1	11-2	11-3	11-4	15-1	15-2	15-3	15-4
3-5	3-6	3-7	3-8	7-5	7-6	7-7	7-8	11-5	11-6	11-7	11-8	15-5	15-6	15-7	15-8
			04#				08#				12#				16#
4-1	4-2	4-3	4-4	8-1	8-2	8-3	8-4	12-1	12-2	12-3	12-4	16-1	16-2	16-3	16-4
4-5	4-6	4-7	4-8	8-5	8-6	8-7	8-8	12-5	12-6	12-7	12-8	16-5	16-6	16-7	16-8

- LED panel installation map for the two 108" LED displays that constitute the Ultra-Wide LED display.

I. The installation sequence of the LED panels impacts both the ease of installing the Ultra-wide LED panels and the flatness of the assembled screen. Follow the LED panel installation sequence outlined below and complete the installation of the LED panels in each cabinet area accordingly.

Please refer to the color block numbering in the diagram. Follow the order from 1 to 4 to sequentially install the LED panels in each designated area of the Ultra-wide LED panels. The installation of LED panels in each color-blocked area must also follow a specific order. Please install them continuously from bottom to top along the plumb line indicated by the arrows in the diagram. Additionally, follow the direction indicated by the dashed white arrows and install the panels continuously in sequence.

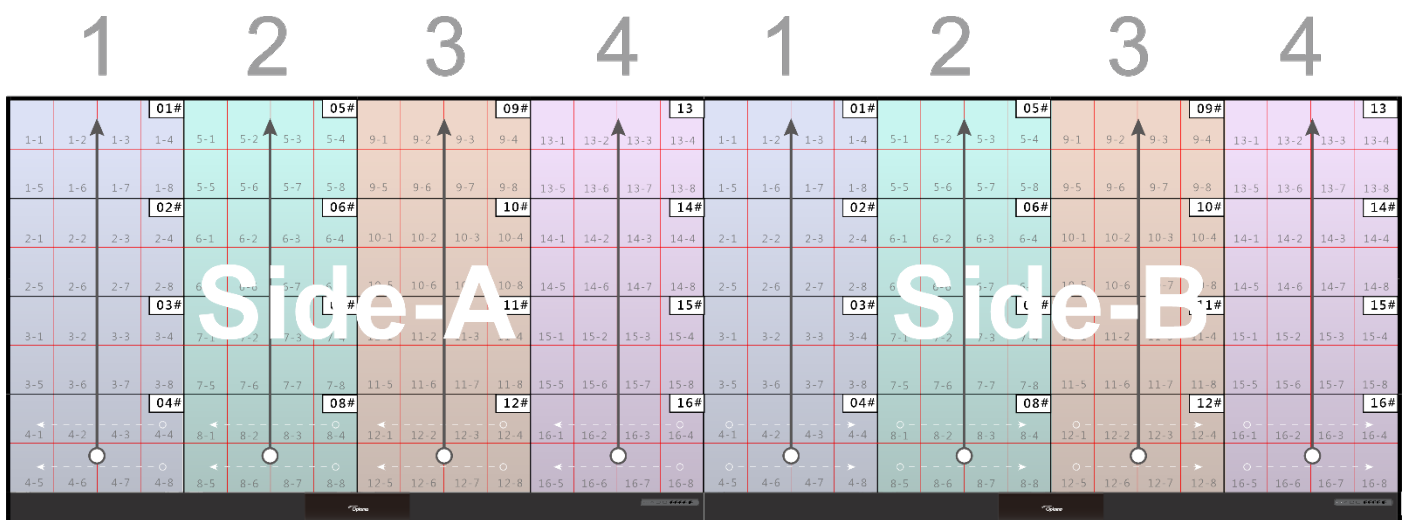

- Installation diagram showing the orientation and sequence of LED panels for a dual tiled display on a 32 : 9 ultra-wide screen.

II. When installing LED panels continuously and adjacently onto the UW196 chassis, ensure that the edge of the LED panel being installed gently touches the edge of the adjacent, already-installed panel. Use this contact point as a pivot to magnetically secure and align the LED panel flat against the UW196 chassis to complete the installation. During the installation process, avoid creating an angle greater than 5 degrees between the panel and the screen to prevent damage caused by potential collisions between the LED surfaces.



Illustration of the correct operation for installing LED panels.

III. Method for adjusting the flatness of spliced LED panel installations.

The UWC196 Ultra-Wide LED display screen consists of 256 mounted LED panels forming a flat surface, supported by adjustable magnetic bolts capable of height rotation.

If height deviations are observed on the supporting surfaces of spliced LED panels, the user can operate the magnet cup bolt height adjustment tool to adjust the magnetic bolts. Turning the bolt clockwise decreases its height, whereas turning it counterclockwise increases its height.

Here is a demonstration of the procedure using a magnetic cup height adjustment tool to correct uneven height defects at the corners of spliced LED panels.

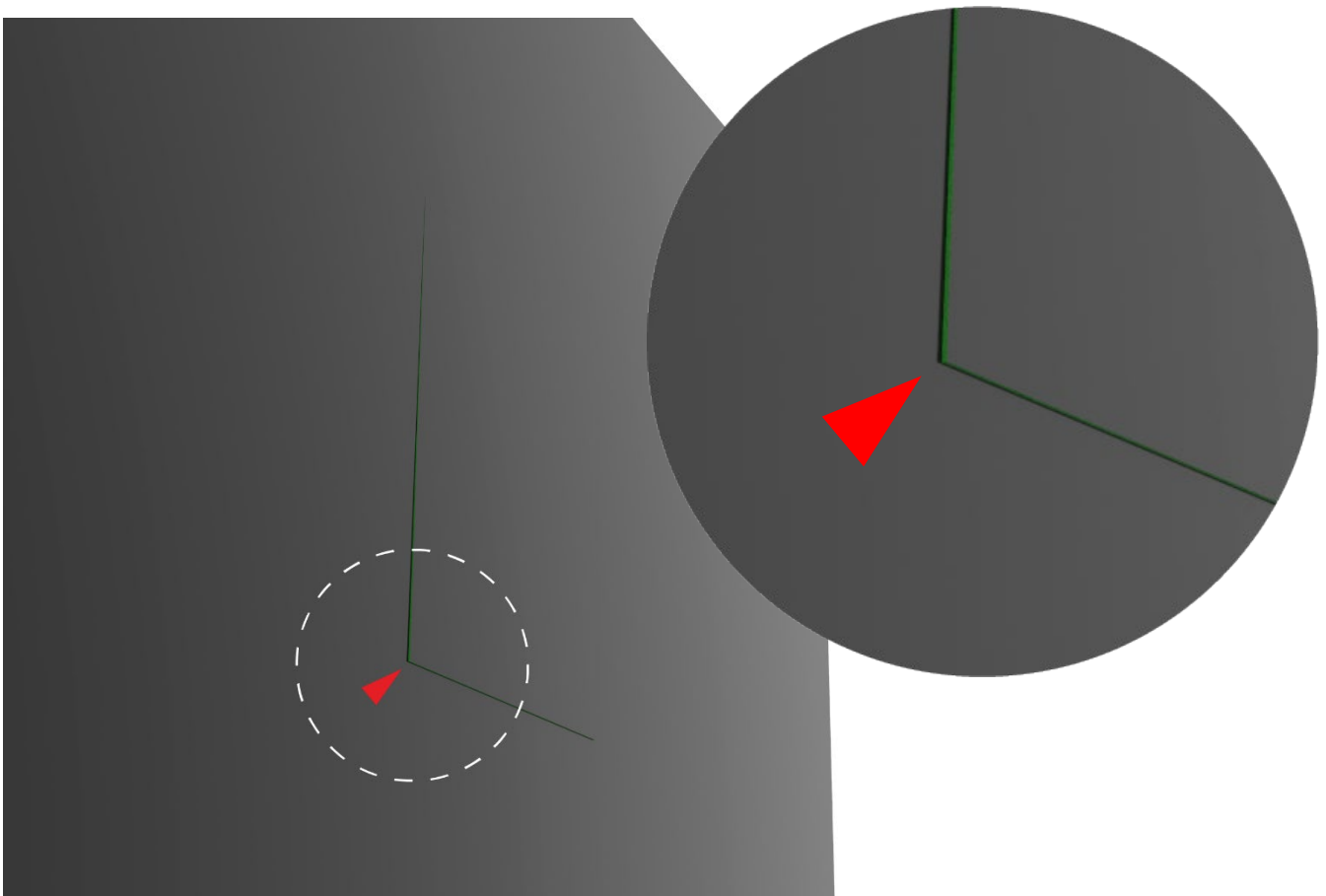

- The arrow in the picture points to the bottom-left corner of the LED panel, where it sticks out from the screen and makes the panel surface look uneven.

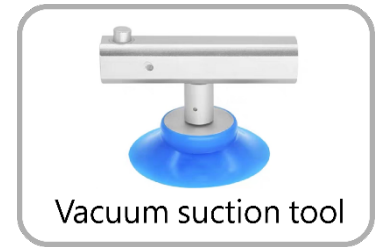
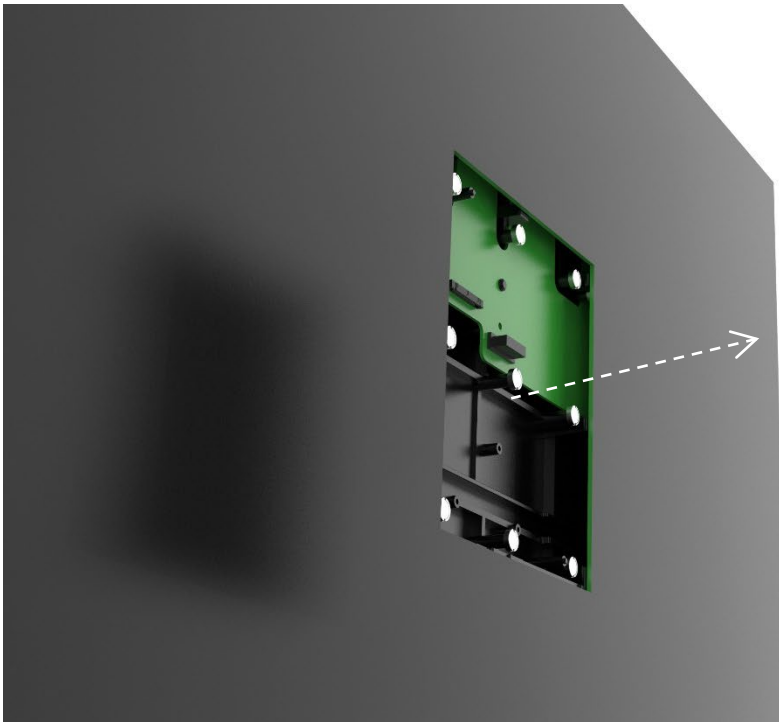

- First, use a [vacuum suction tool](#) to remove the uneven LED panel and place it properly.

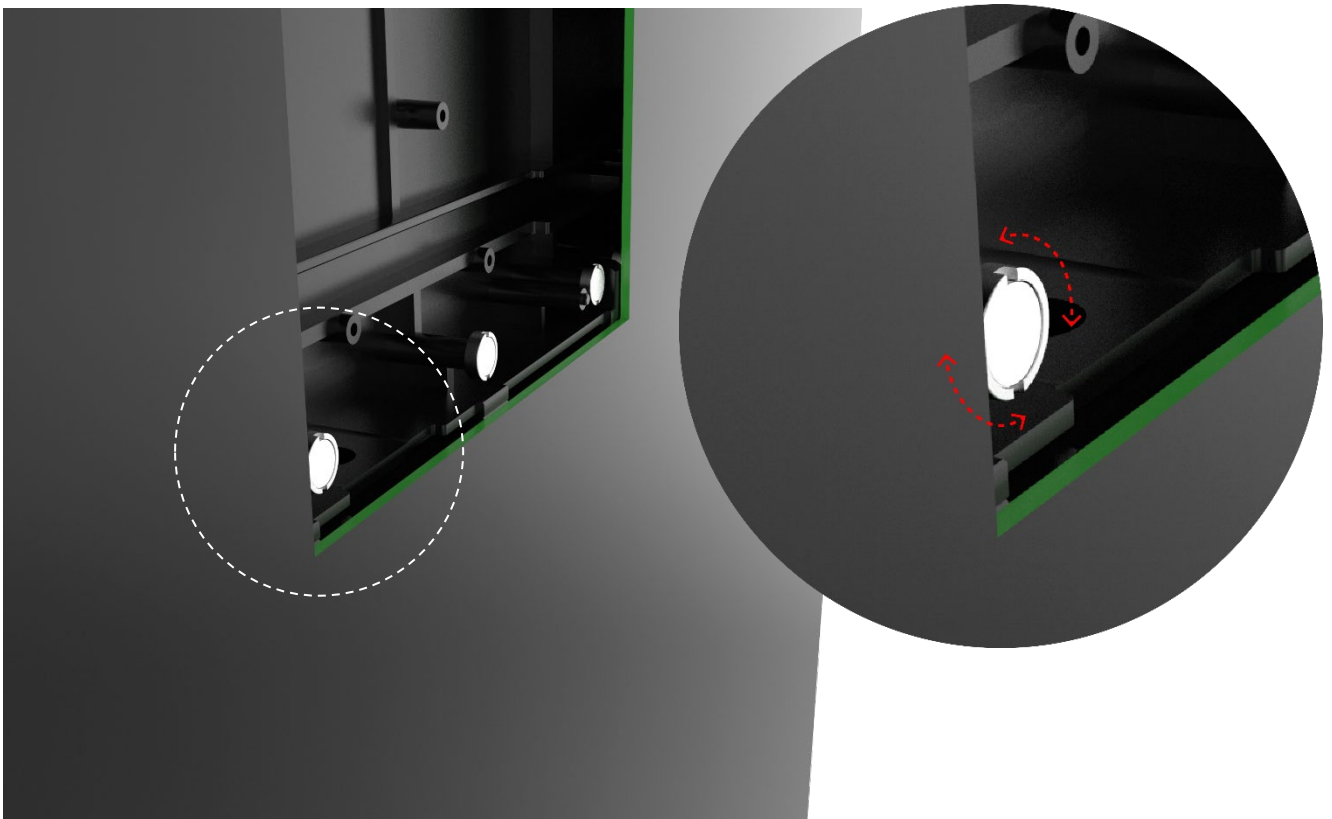

- After taking off the LED panel, pinch the magnetic cup screw under the uneven spot with your thumb and index finger, and gently twist it left and right to see if it's loose or raised.

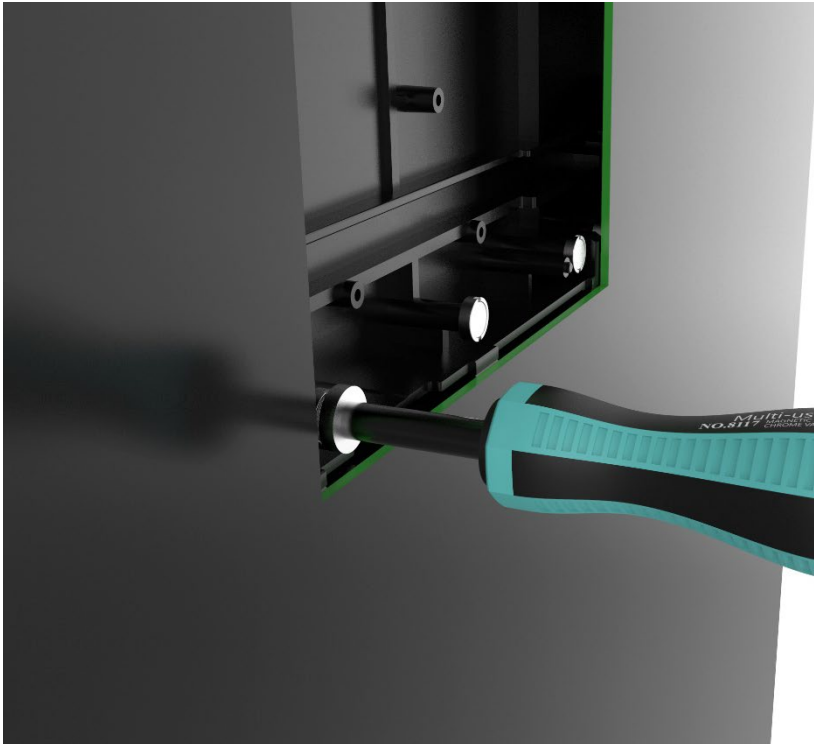

- If the magnetic cup screw at that location is loose and can be rotated, use the magnet height adjustment tool to engage the screw, then tighten it clockwise with a torque of **3 Kg.cm**.



- After confirming that all magnetic cup screws have been tightened, carefully reinstall the previously removed LED panel to its original position, and check again to ensure that the panels are aligned into a flat surface.

Step 8 : Install the bottom frame cover plate

1) Install the bottom frame cover plate, according to the installation diagram, install the cover plate from right to left in order. The cover plate has locating pins in its original color. After aligning the pins, the cover plate will be fixed to the bottom frame through magnetic attraction, as shown in the figure below :

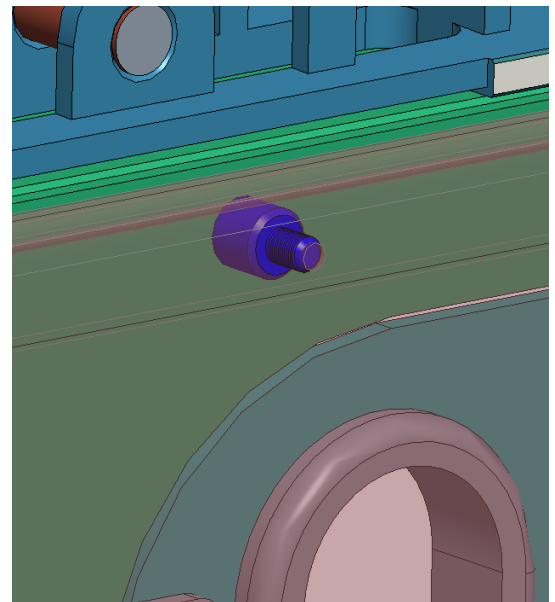
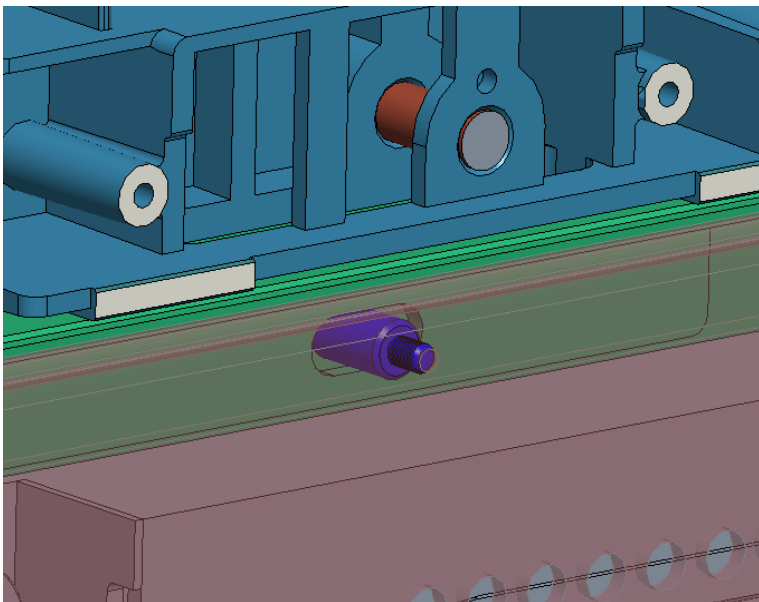
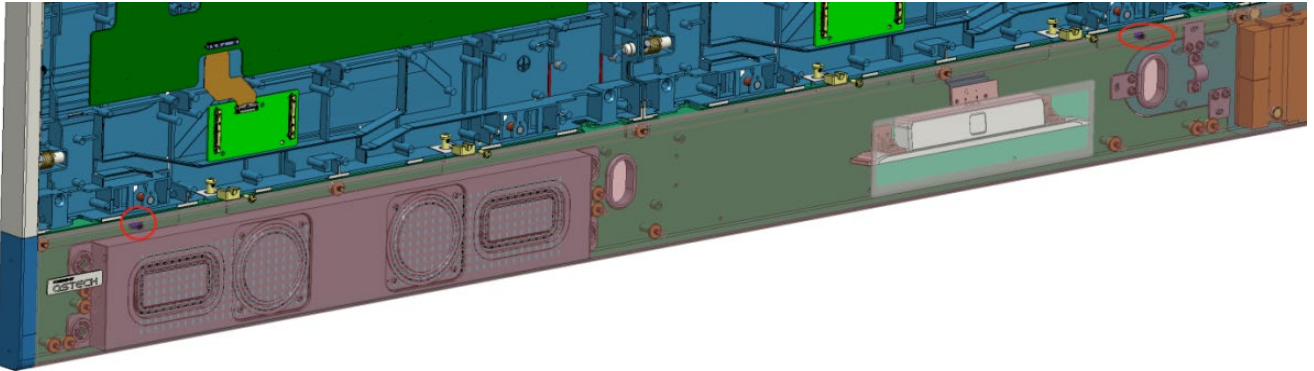

Step 9 : OPTOMA LCT V2 Installation and Display Configuration SOP

A. Preparation: Set Up Device Network Connection

1. Wireless Connection (Hotspot Mode)

- a. Enable the device' s wireless hotspot:
- b. Settings → Wireless Hotspot → Hotspot switch → Enable.
- c. The SSID and password will be displayed on the screen.
- d. On your computer, connect to the displayed SSID using the password.

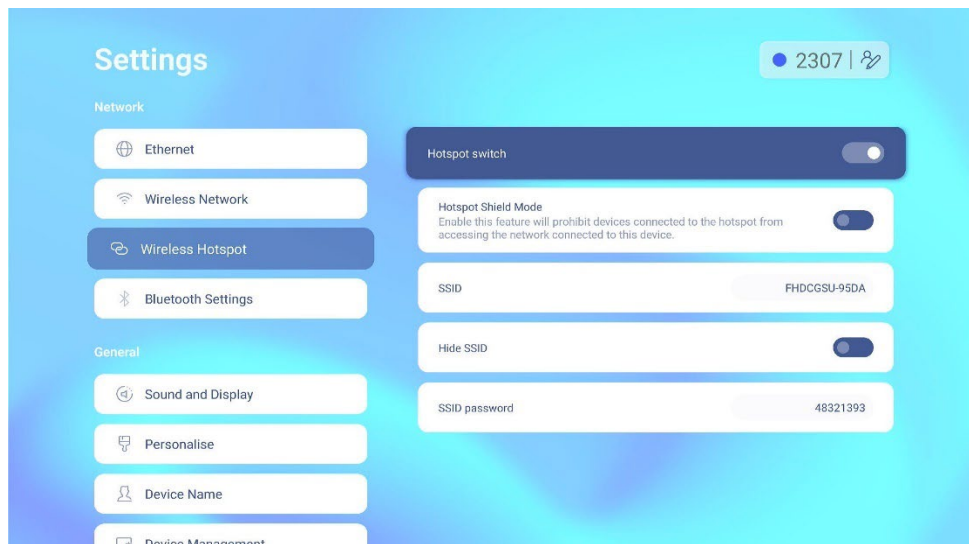

2. Wired Connection (Static IP Mode)

Ensure that the computer and the AiO device are connected to the same local network, or directly connected via Ethernet.

Enable Ethernet on the AiO:

Settings → Ethernet → Ethernet → Enable

- a. For DHCP:
 1. Confirm the IP address is automatically assigned.
- b. For static IP:
 1. Set AiO IP to 192.168.100.201

2. Mask: 255.255.255.0

3. Set the computer IP to the same subnet, e.g., 192.168.100.x (x ≠ 201)

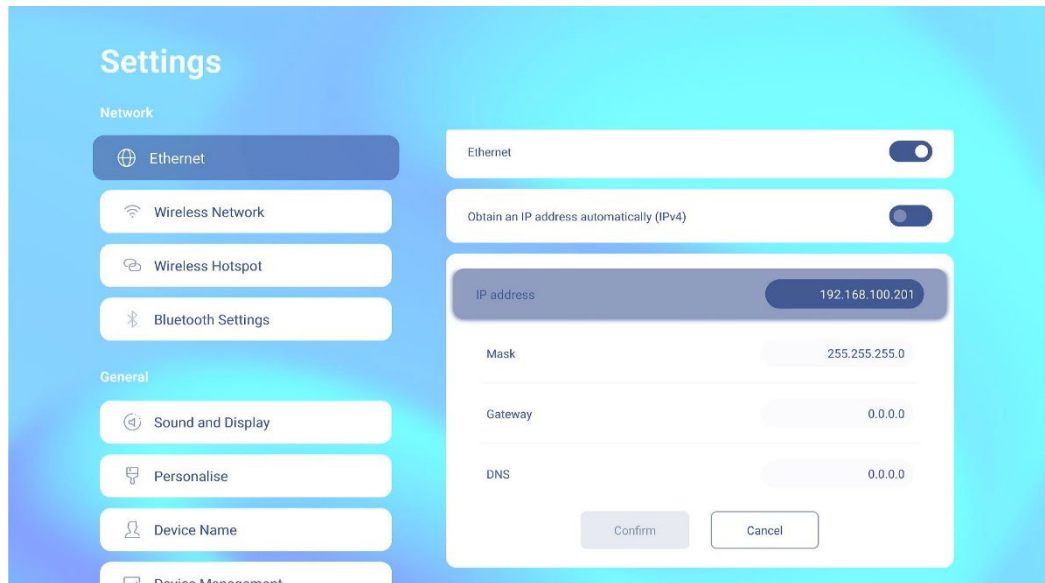

B. Install OPTOMA LCT V2 Software:

1. Insert the USB drive into the computer. Navigate to:
2. Software and hardware programs → Control software
3. Run the installer and complete the installation.
4. Launch the OPTOMA LCT V2 software.

C. Establish Connection and Enter Advanced Settings

1. Connect to Device
 - a. Launch the OPTOMA LCT V2 software.

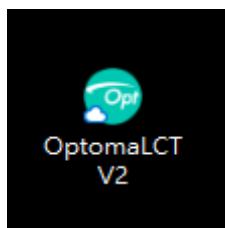

- b. Click the Reload icon in the upper-left corner. The device information

should appear.

c. Click Connect to establish the connection.

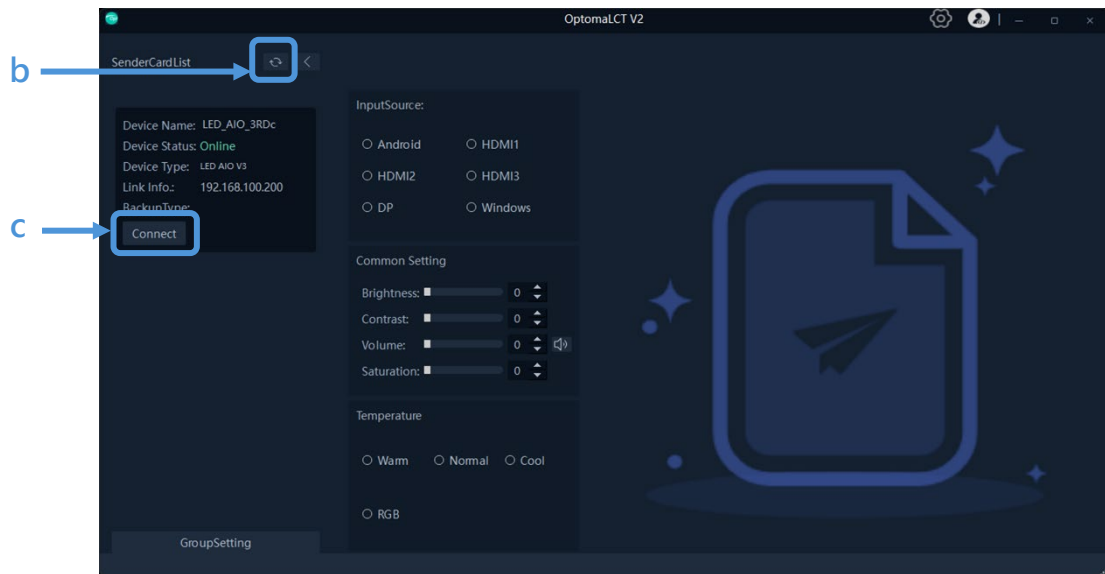

2. Enter Advanced Mode

a. Click the account icon in the top right corner to enter advanced mode.

b. When prompted, enter the password: Optoma

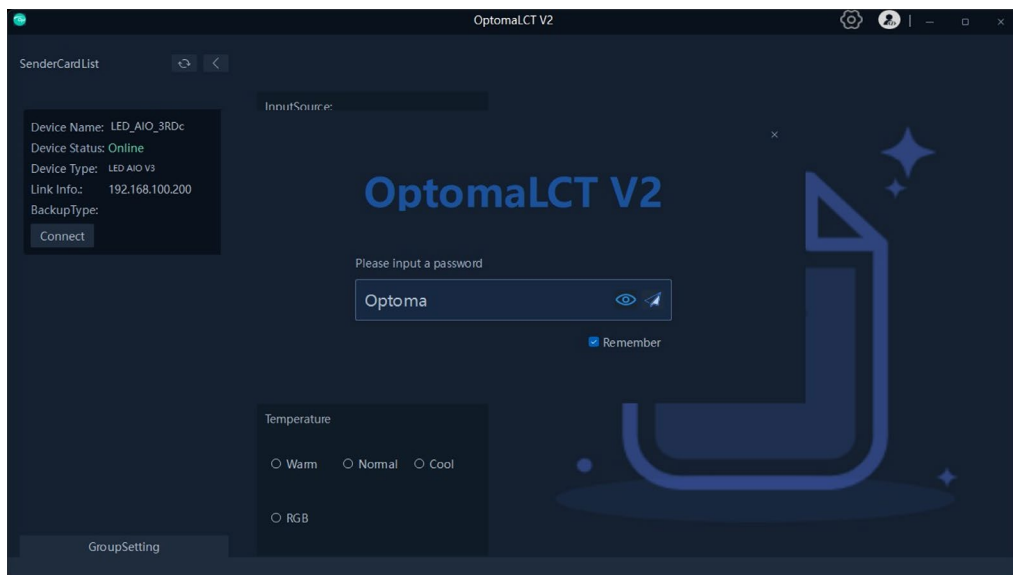

c. Select profession-debug to enter the advanced configuration mode.

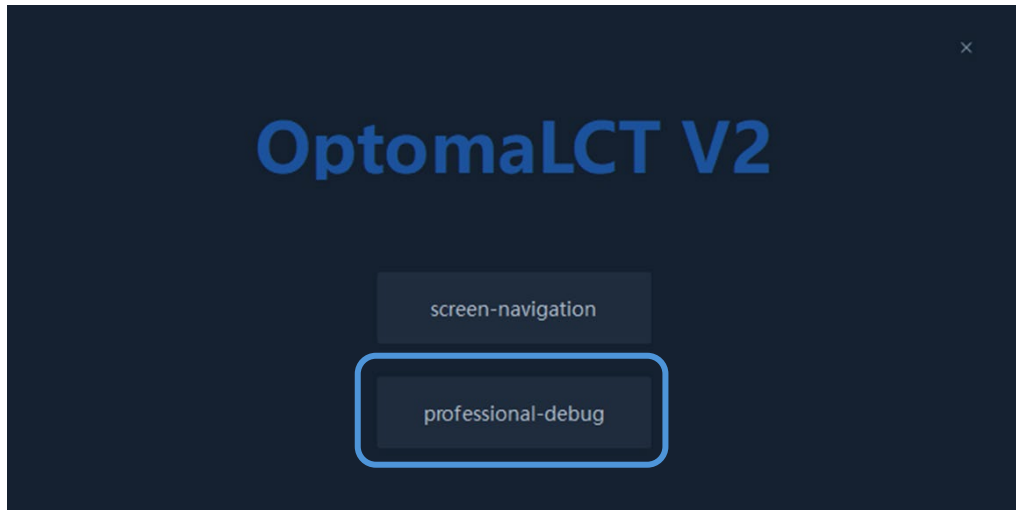

D. Resolution and EDID Settings:

1. Configure Screen Resolution and EDID

- a. Click the Screen tab at the top to enter the Screen page.
- b. Click the HDMI Setting button in the lower-right corner.

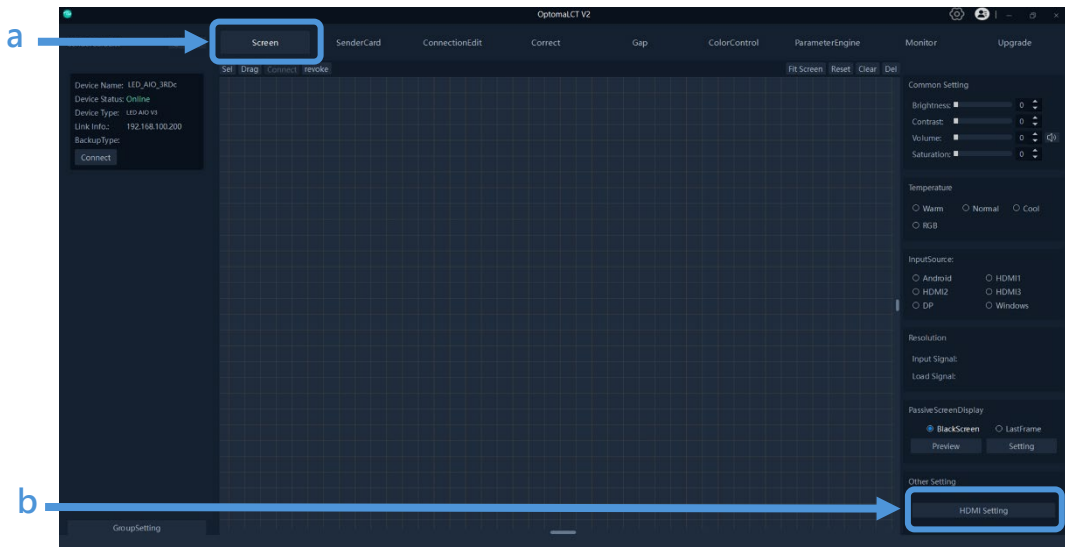

c. Under Area Settings, enter:

1. Width: 3840, Height: 1080.
2. Click Send to apply settings to the AiO.

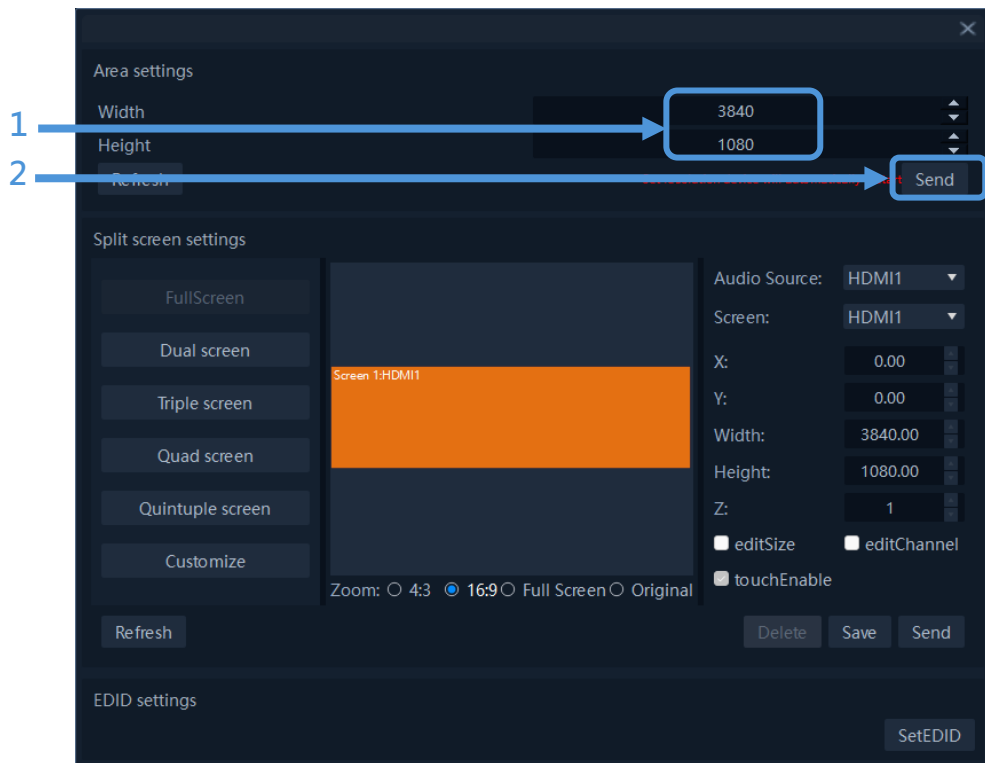

2. To set EDID:

- a. Click the SetEDID button in the lower-right corner.

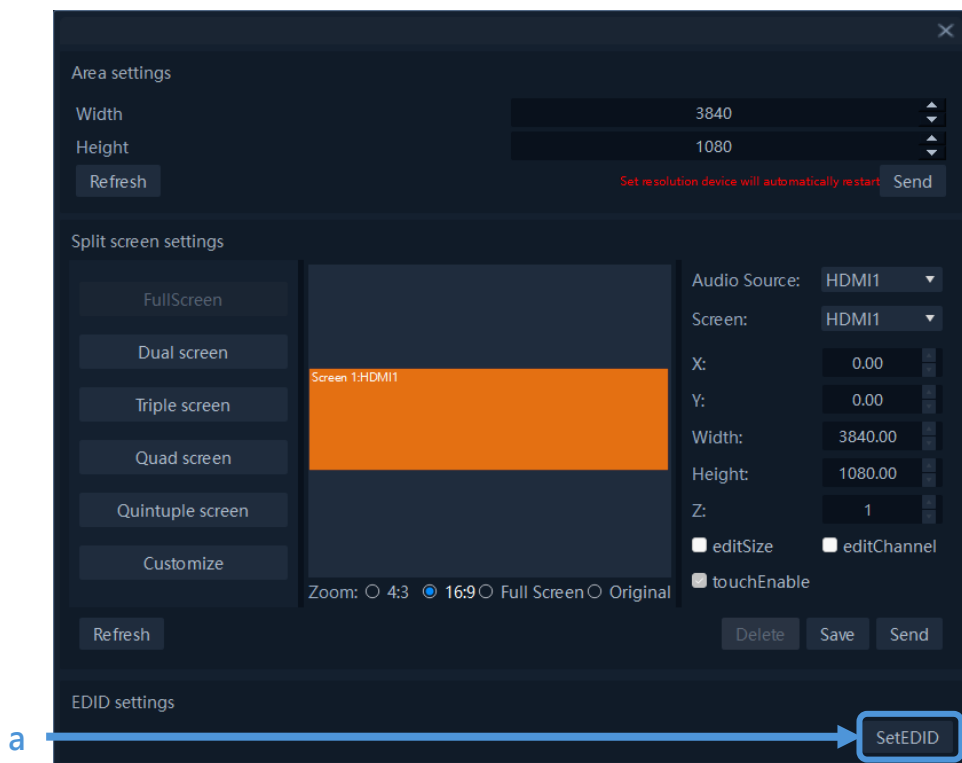

- b. Select HDMI1.
- c. Click the ... button next to File Name to choose the EDID file.
- d. Click Set EDID to complete the setting.

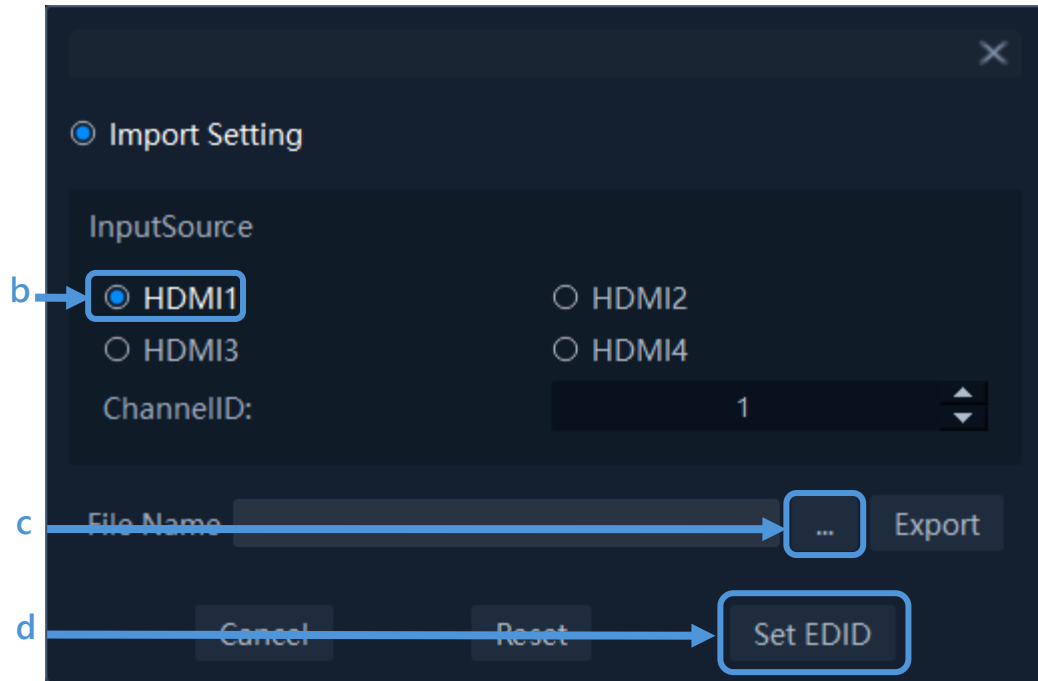

E. Display Mapping Configuration

1. Enter Display Connection Page
2. Click the ConnectionEdit tab at the top.

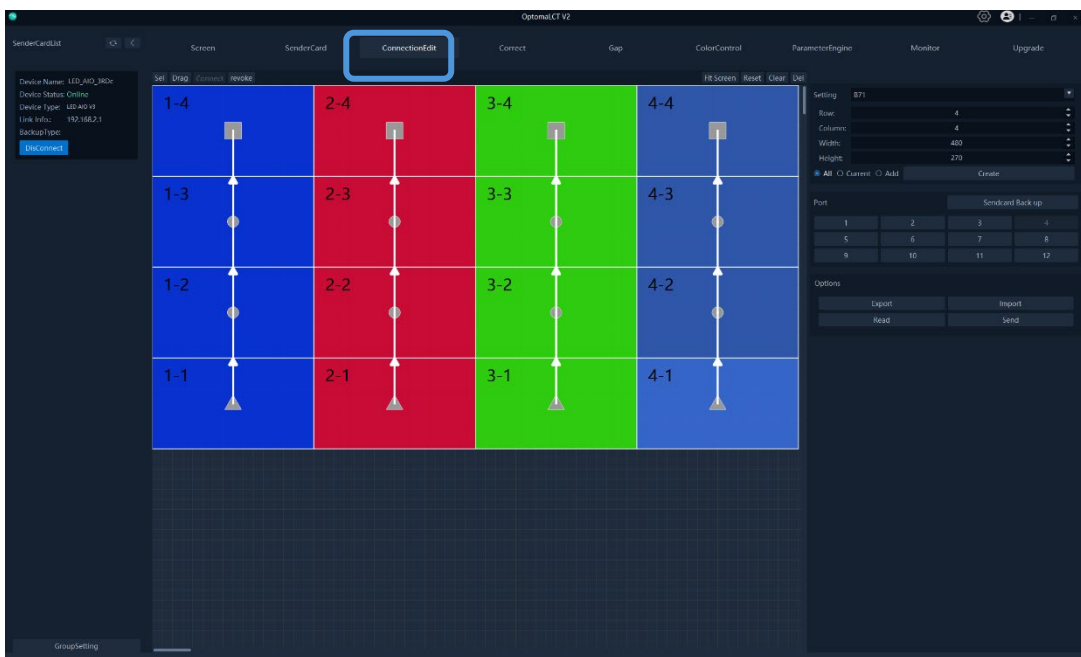

3. Method 1: Import Configuration File

- a. Click Option → Import in the lower-right corner to import the display configuration file.
- b. Verify Port 1 to Port 8 mappings. If correct, click Send to apply the settings to the AiO.

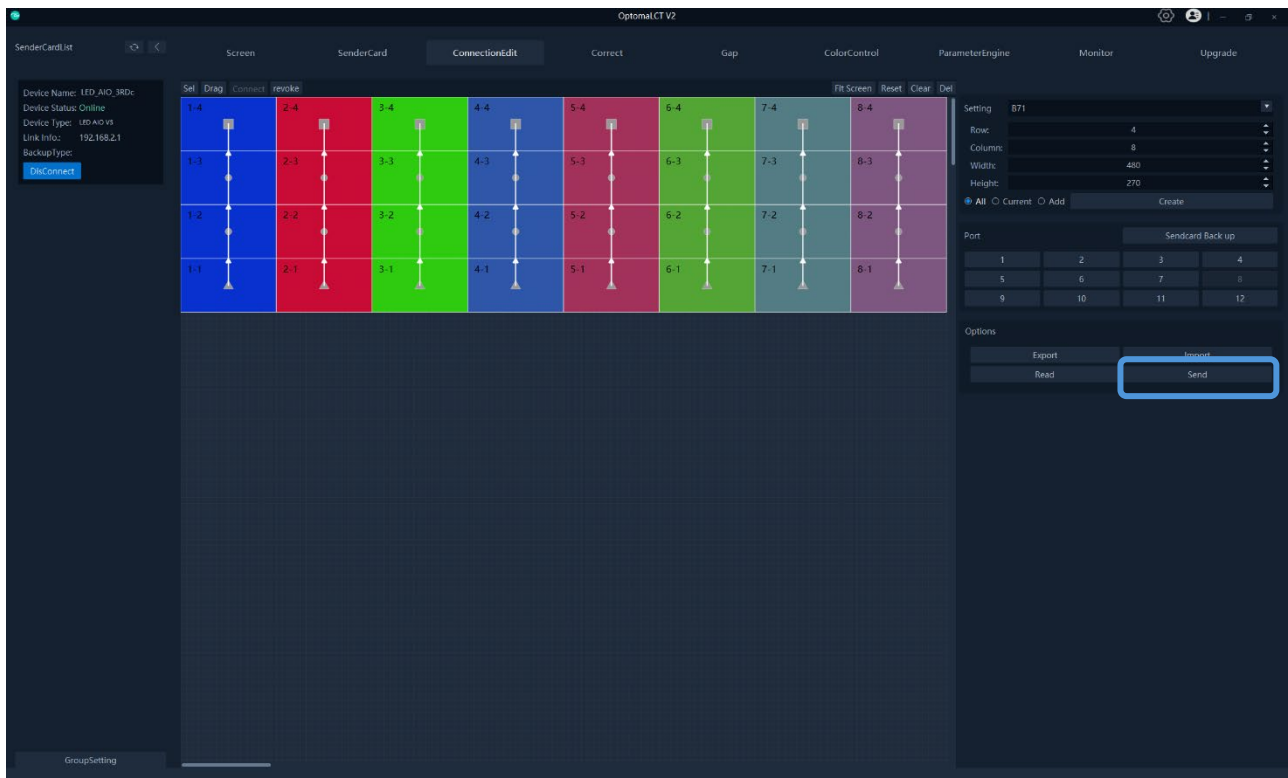

4. Method 2: Manual Configuration

- a. Input the following values at the top right configuration section:
 1. Row: 4.
 2. Column: 8.
 3. Width: 480.
 4. Height: 270.
 5. Click Create to generate the mapping table.

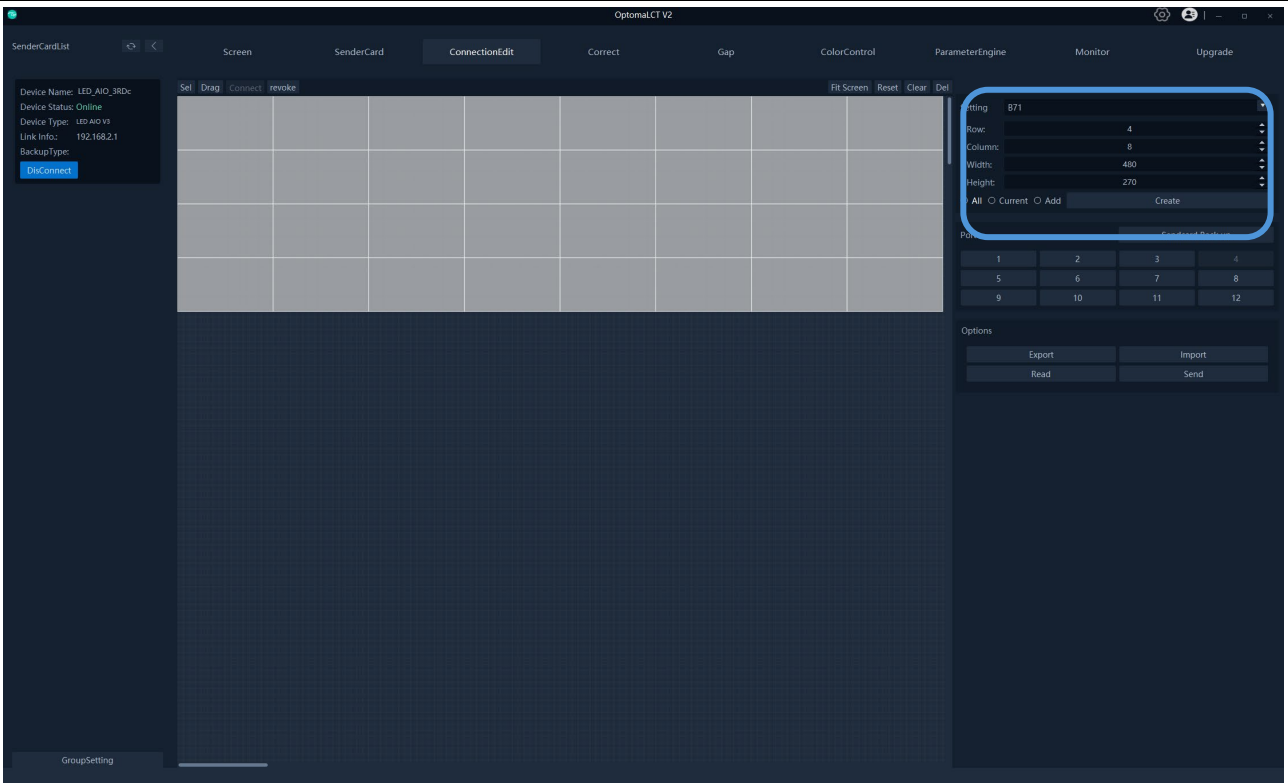

b. For each port:

1. Click Port 1 → Drag from the bottom to top of the first row to display 1-1 to 1-4.
2. Repeat for Port 2 through Port 8
3. If errors occur, use revoke to undo or clear to reset.
4. After completing the mapping, click Send to apply to the display.

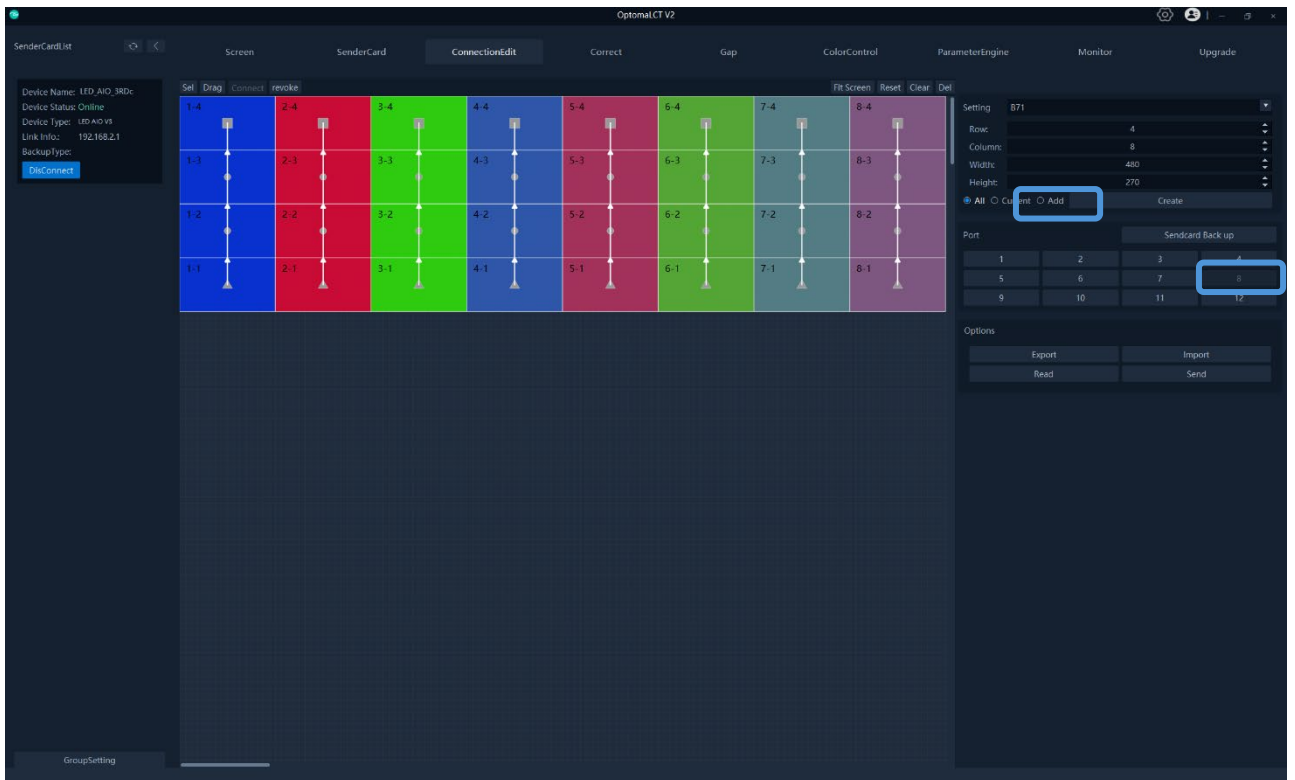
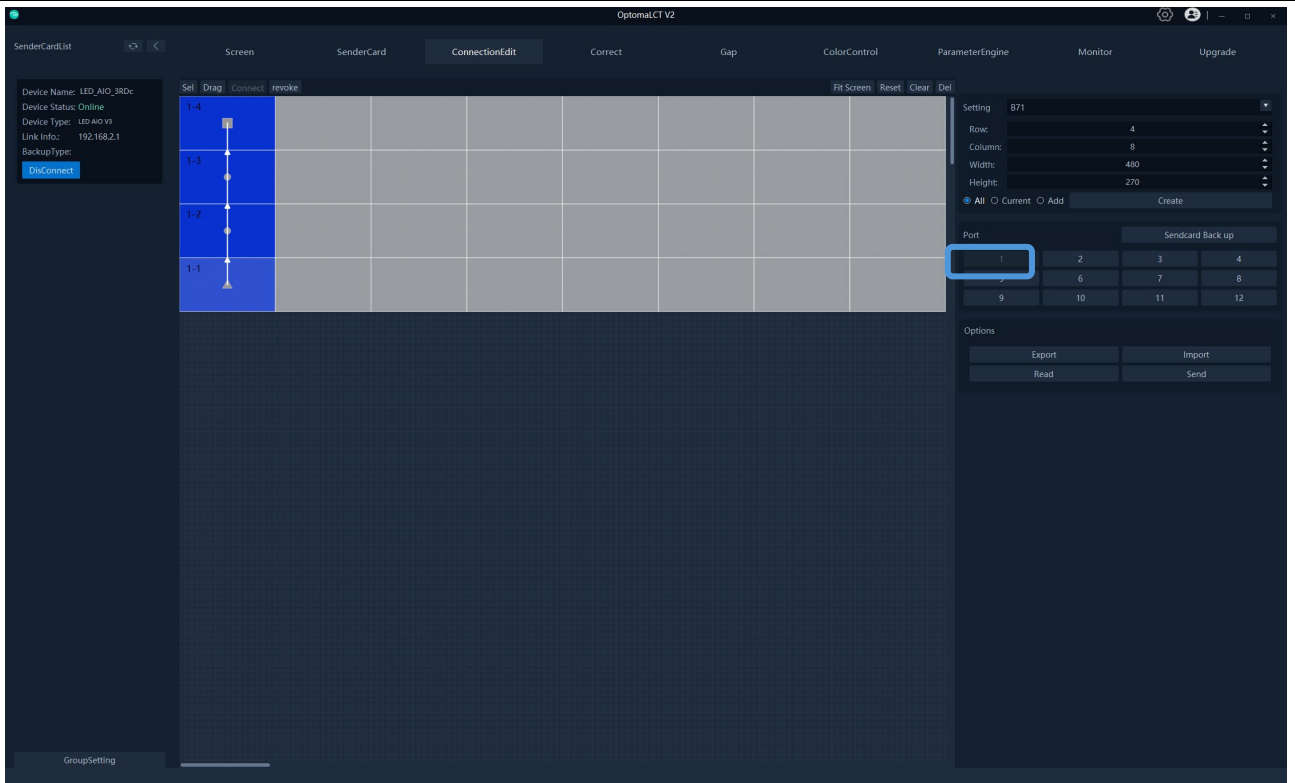

Appendix 1

HQScene200 3840*1080 Freeform Setting

Step 1. Hardware connection

Connect HQScene200 output port to UWC196 HDMI 1 (only HDMI 1 support 3840*1080 in UWC196)



Step 2. Change Output resolution to 3840*1080

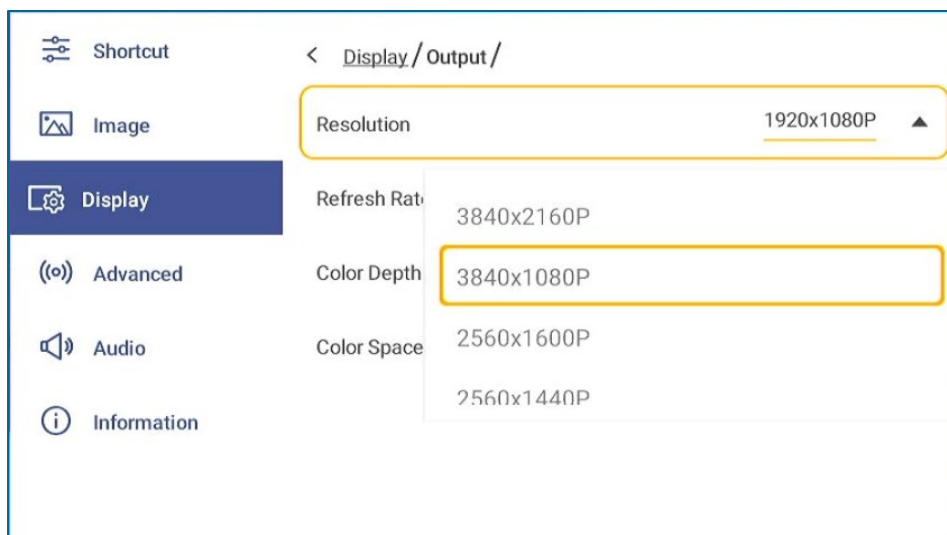

Step 3. Change resolution of Input EDID to 3840*1080

3-1. Open the Input page (Menu/Display/Input) and change the resolution of **HDMI 1** EDID to **3840x1080P**.

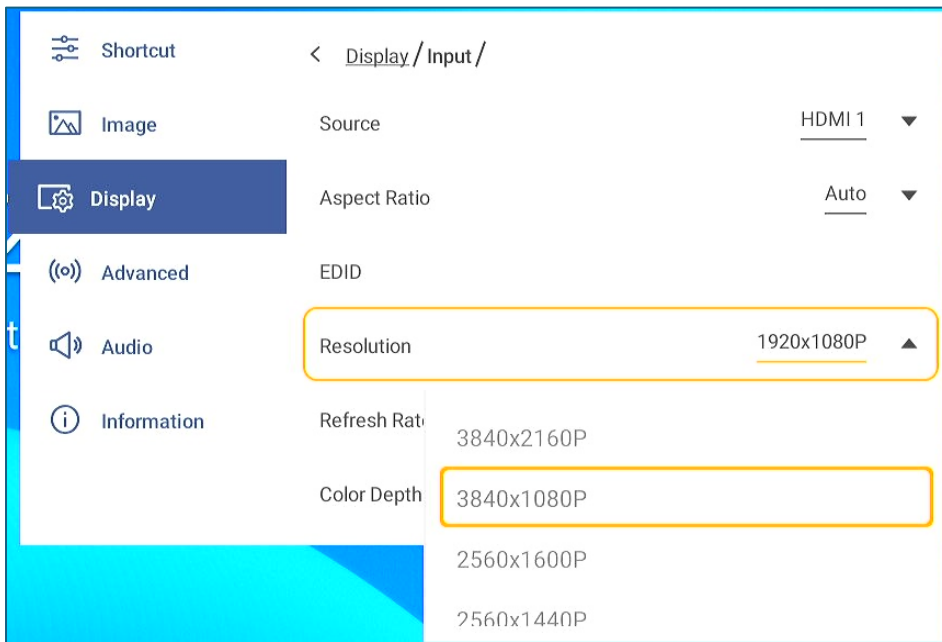

3-2. Open your computer's display page (Settings/Display), select your display and check that the display resolution is 3840x1080 (recommended) and that a multi-monitor setup is set to extend those monitors.

Notice :

If your display does not meet the following conditions, it means that your device cannot support special resolution output and you need to change another output device.

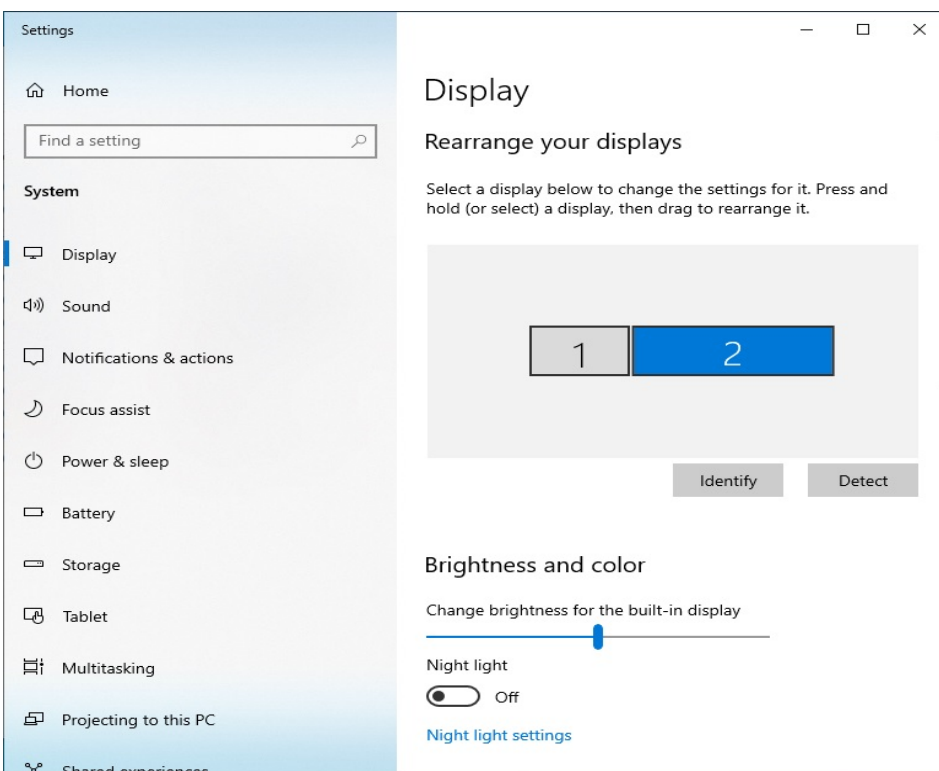

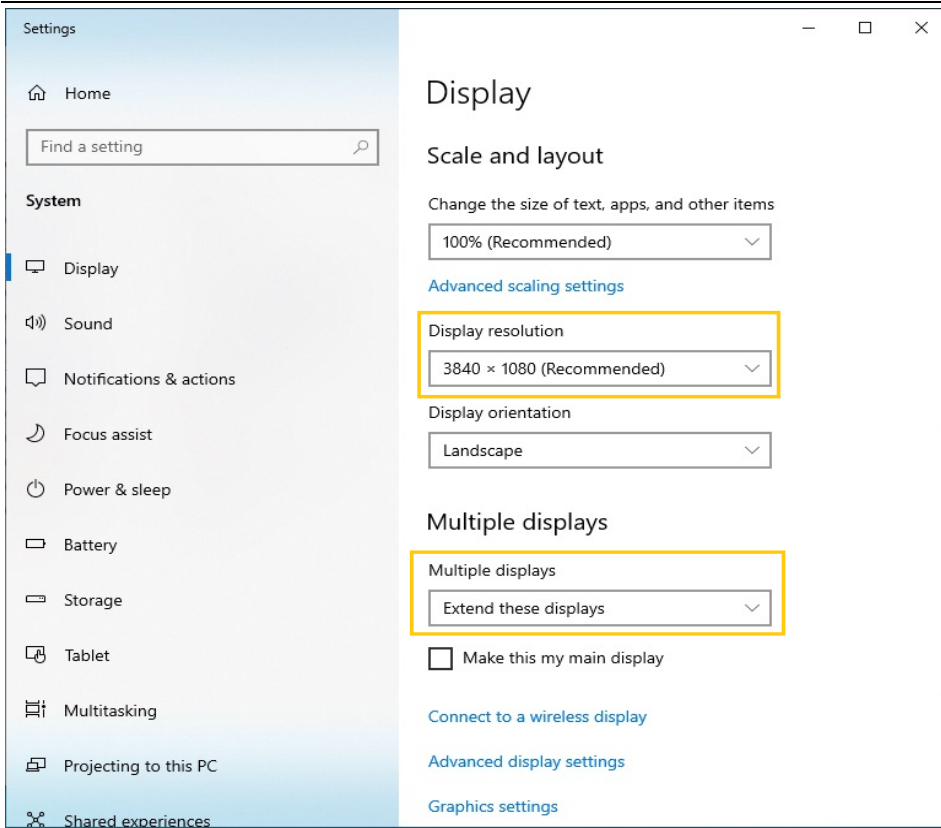

3-3. Open the Display page (Menu/Information/Display) and check that the resolution of the input HDMI 1 is 3840x1080P.

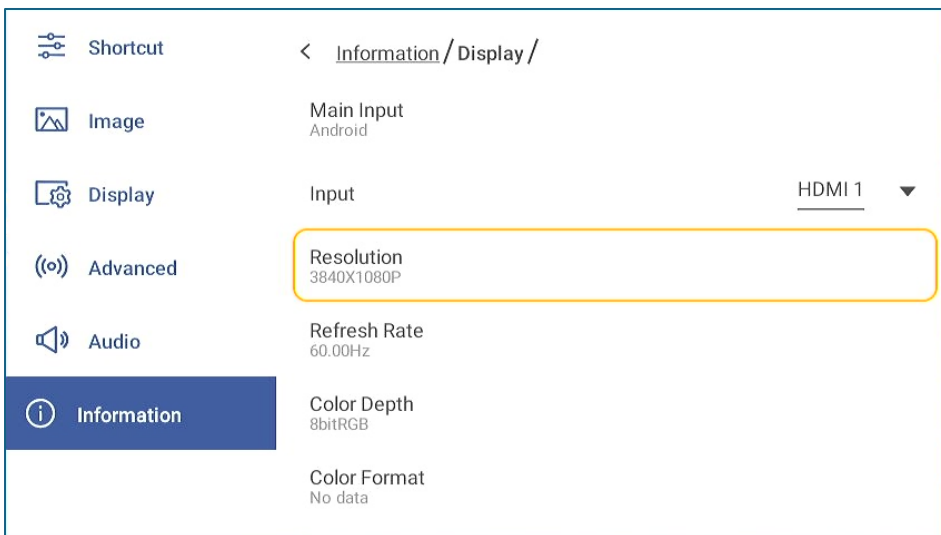

Situation: Full Screen and Side by Side

1. Turn on freeform function.

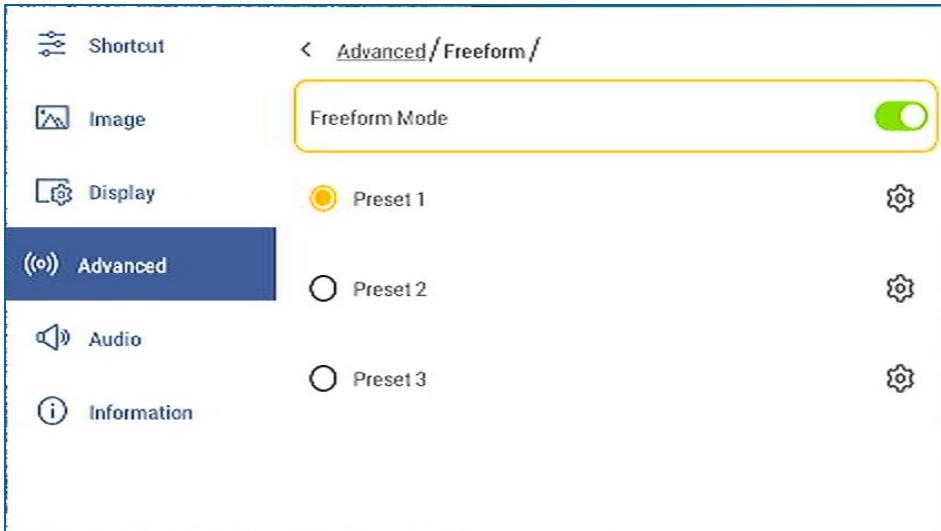

2. Select Preset 1 (Full Screen, HDMI 1 as input)



- 2-1. Click the gear icon on the right side of Preset 1.

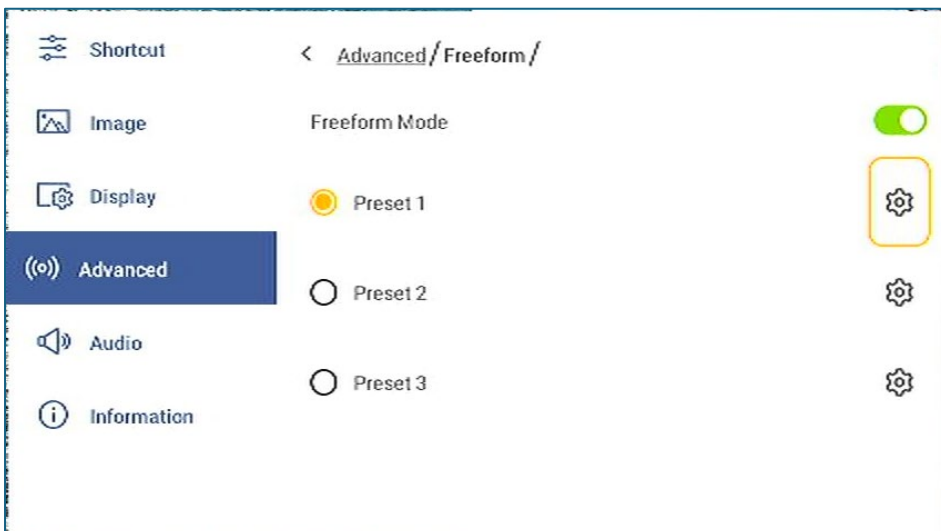

2-2. Set Preset 1 according to the following parameters.

- Layer 1: Enable
 - ✓ Input: HDMI 1
 - ✓ Width: 3840 px, Height: 1080 px, H. Position: 0 px, V. Position: 0 px.
- Layer 2: Disable
- Layer 3: Disable
- Layer 4: Disable

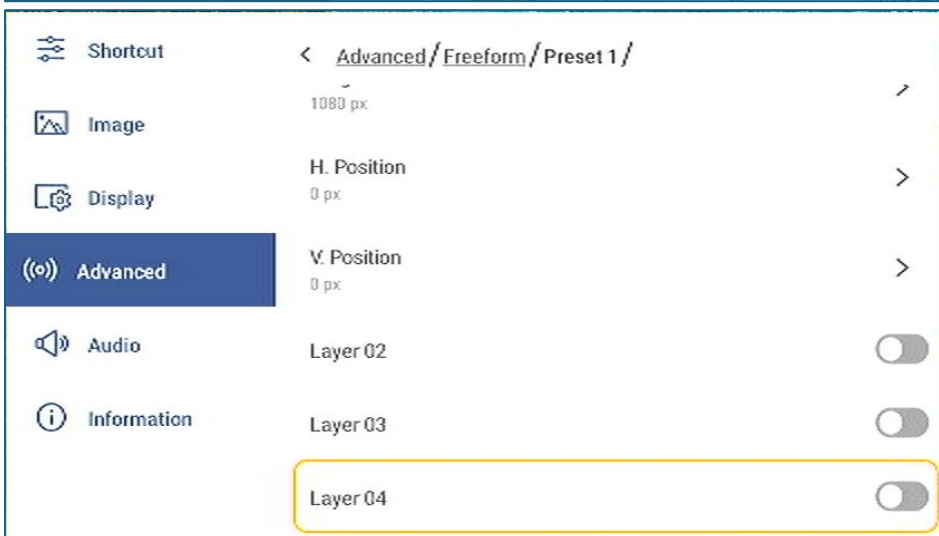

3. Select Preset 2 (Side By Side, HDMI 2, HDMI 3 as input)

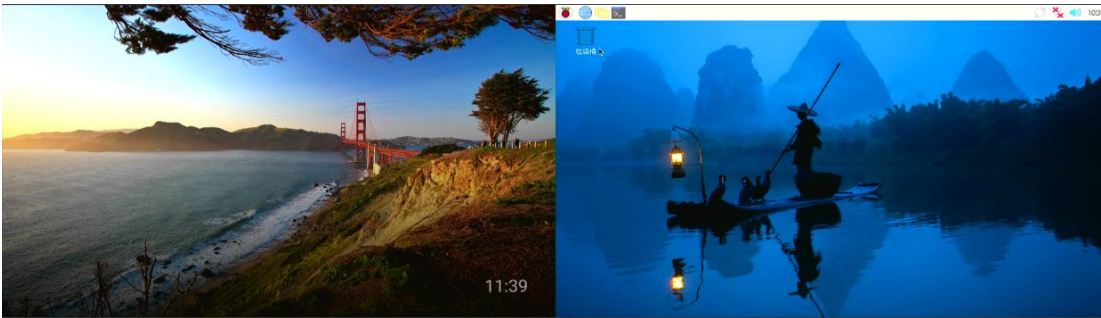

3-1. Click the gear icon on the right side of Preset 2.

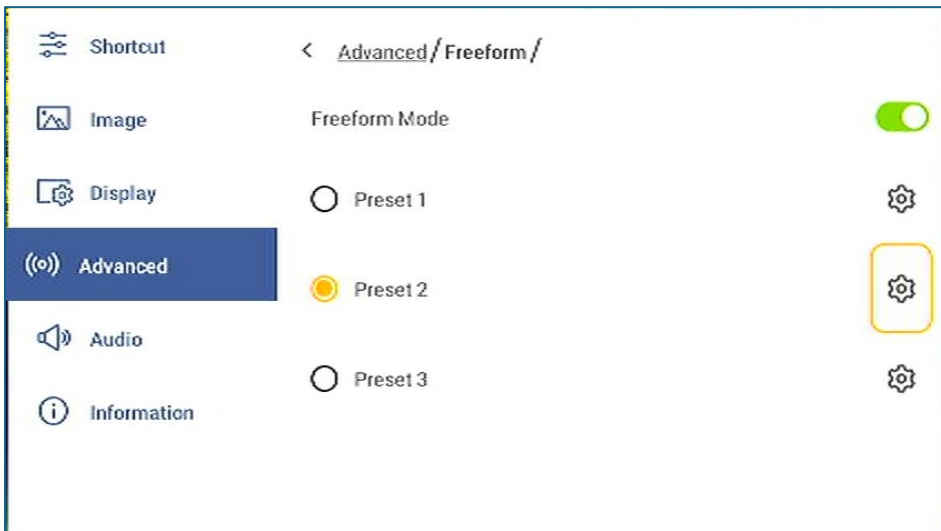

3-2. Set Preset 2 according to the following parameters.

- Layer 1: Enable
 - ✓ Input: HDMI 2
 - ✓ Width: 1920 px, Height: 1080 px, H. Position: 0 px, V. Position: 0 px.
- Layer 2: Enable
 - ✓ Input: HDMI 3
 - ✓ Width: 1920 px, Height: 1080 px, H. Position: 1920 px, V. Position: 0 px.
- Layer 3: Disable
- Layer 4: Disable

Shortcut < Advanced / Freeform / Preset 2 /

Image Layer 01

Display Input HDMI 2 ▼

(o) Advanced Width 1920 px >

Audio Height 1080 px >

Information H. Position 0 px >

Shortcut < Advanced / Freeform / Preset 2 /

Image u px

Display V. Position 0 px >

(o) Advanced Layer 02

Audio Input HDMI 3 ▼

Information Width 1920 px >

Height 1080 px >

Shortcut < Advanced / Freeform / Preset 2 /

Image 1920 px

Display Height 1080 px >

(o) Advanced H. Position 1920 px >

Audio V. Position 0 px >

Information Layer 03

Layer 04

4. Set Preset 3 (Side by Side, HDMI 2 as input).

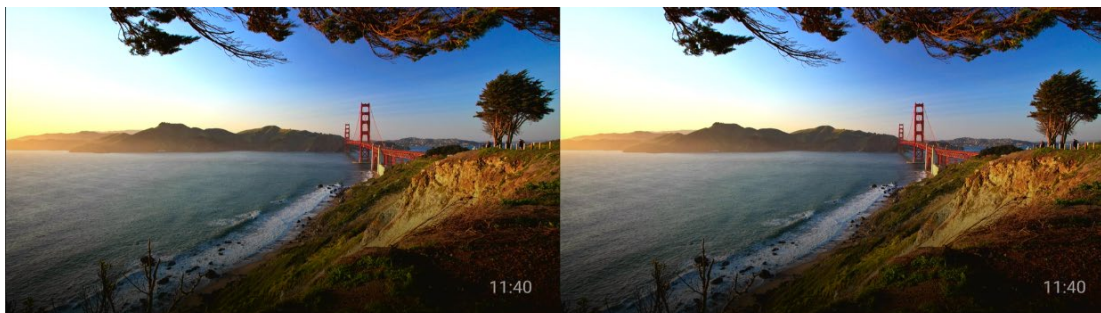

4-1. Click the gear icon on the right side of Preset 3.

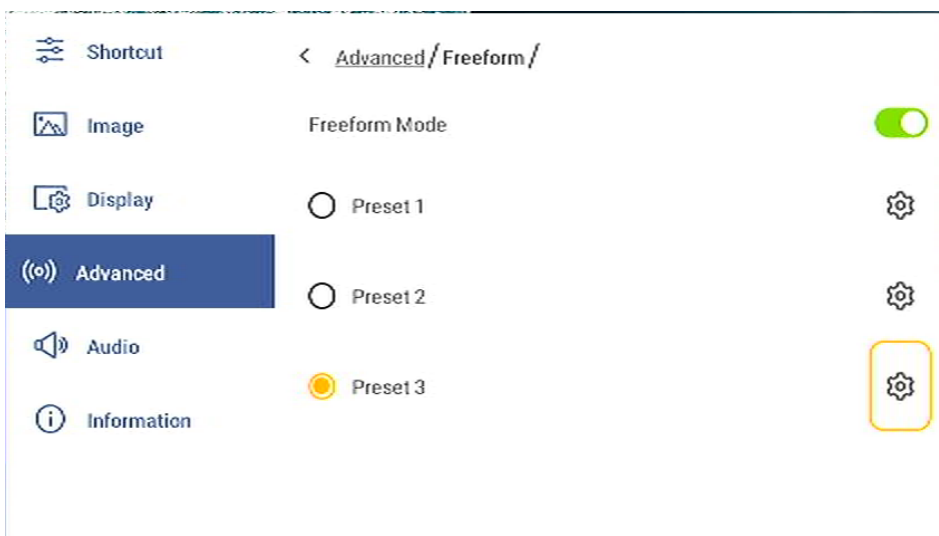

4-2. Set Preset 3 according to the following parameters.

- Layer 1: Enable
 - ✓ Input: HDMI 2
 - ✓ Width: 1920 px, Height: 1080 px, H. Position: 0 px, V. Position: 0 px.
- Layer 2: Enable
 - ✓ Input: HDMI 2
 - ✓ Width: 1920 px, Height: 1080 px, H. Position: 1920 px, V. Position: 0 px.
- Layer 3: Disable

- Layer 4: Disable

Shortcut < Advanced / Freeform / Preset 3 /

Image Layer 01

Display Input HDMI 2 ▼

(ⓘ) Advanced Width 1920 px >

Audio Height 1080 px >

Information H. Position 0 px >

Shortcut < Advanced / Freeform / Preset 3 /

Image V. Position 0 px >

Display Layer 02

(ⓘ) Advanced Input HDMI 2 ▼

Audio Width 1920 px >

Information Height 1080 px >

Shortcut < Advanced / Freeform / Preset 3 /

Image Height 1080 px >

Display H. Position 1920 px >

(ⓘ) Advanced V. Position 0 px >

Audio Layer 03

Information Layer 04

5. Switch Preset 1~3

5.1. Select preset from OSD freeform menu directly.

5.2. Press freeform switch shortcut key on the remote control can toggle sequentially through three presets



Situation: OMS Alert

1. Side by Side + OMS emergency alerts

1.1 Follow the freeform side-by-side situation setting

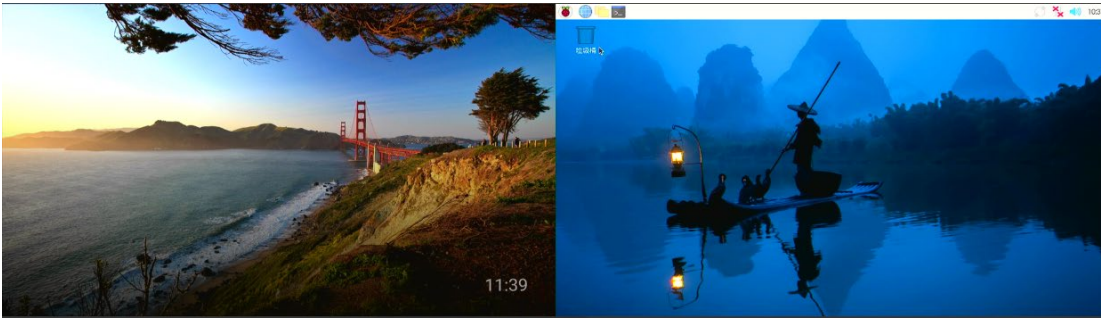

1.2 Send broadcast emergency alert from OMS server. The alert image will be displayed in the center.



2. Three layers side by side + OMS general Alert

2.1 Use freeform preset and set it as below:

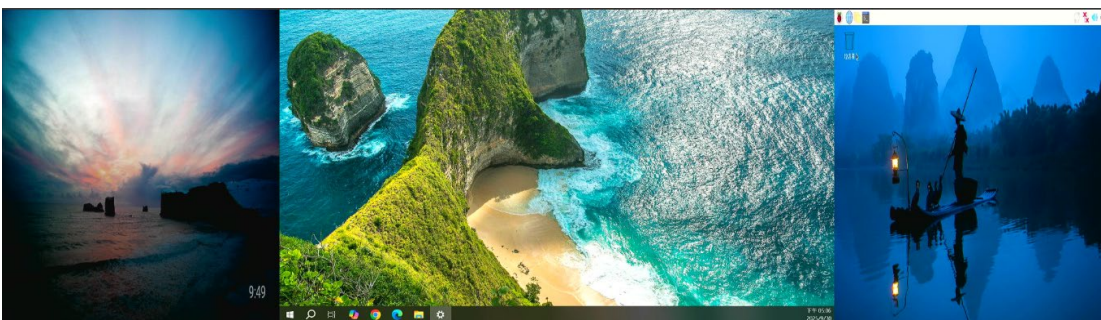

- Layer 1: Enable
- ✓ Input: HDMI 1

✓ Width: 1920 px, Height: 1080 px, H. Position: 960 px, V. Position: 0 px.

● Layer 2: Enable

✓ Input: HDMI 2

✓ Width: 960 px, Height: 1080 px, H. Position: 0 px, V. Position: 0 px.

● Layer 3: Enable

✓ Input: HDMI 3

✓ Width: 960 px, Height: 1080 px, H. Position: 2880 px, V. Position: 0 px.

● Layer 4: Disable

2.2 Send broadcast general alert from OMS server. The alert text string will be displayed in the in the center.

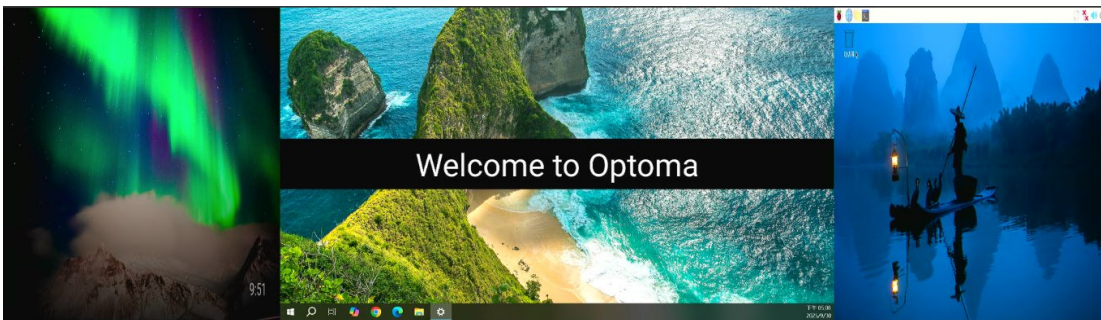

Situation: Customized two-layer, three-layer and four-layer (Layers support overlay)

1. Turn on freeform function. User can configure three preset scenarios.

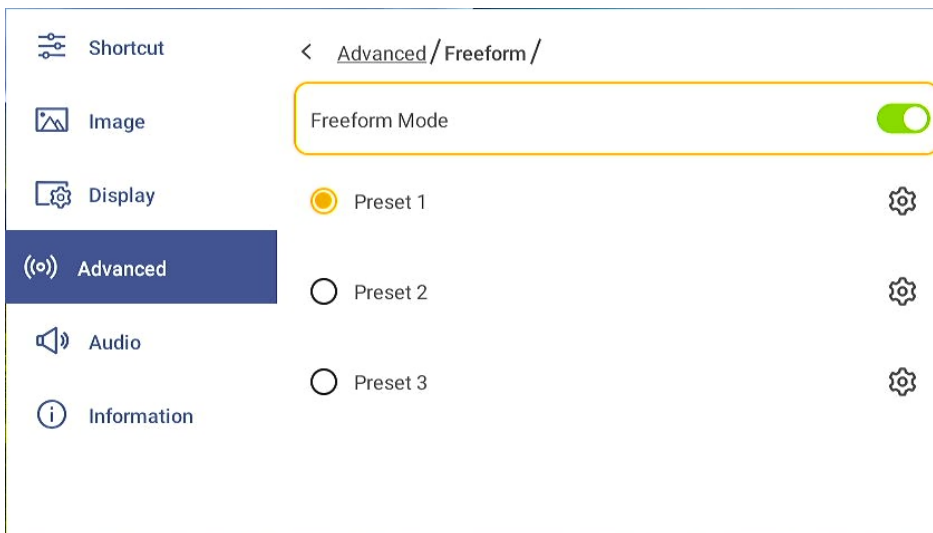

2. Customized two-layer

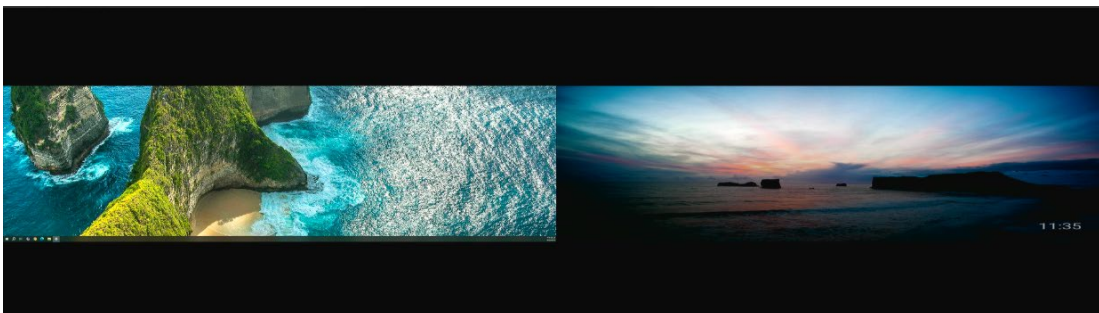

2-1. Turn on Layer 1 and Layer 2.

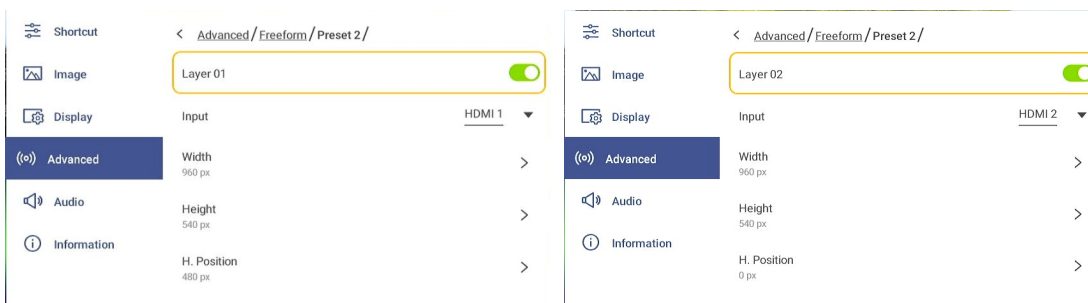

2-2. Adjust Input, Width, Height, H Position, V Position of layer 1 and layer 2

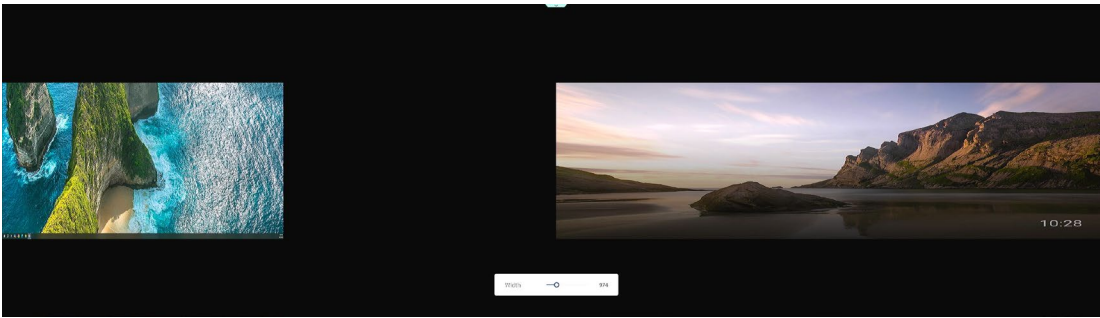

3. Customized three-layer

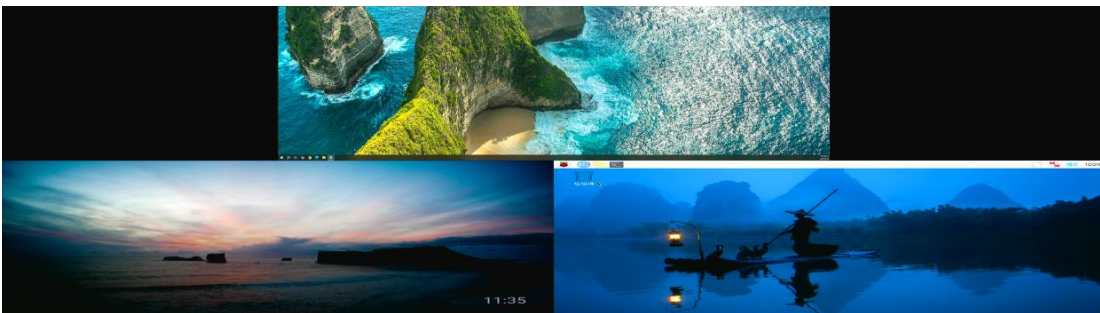

3-1. Turn on Layer 1, Layer 2 and Layer 3.

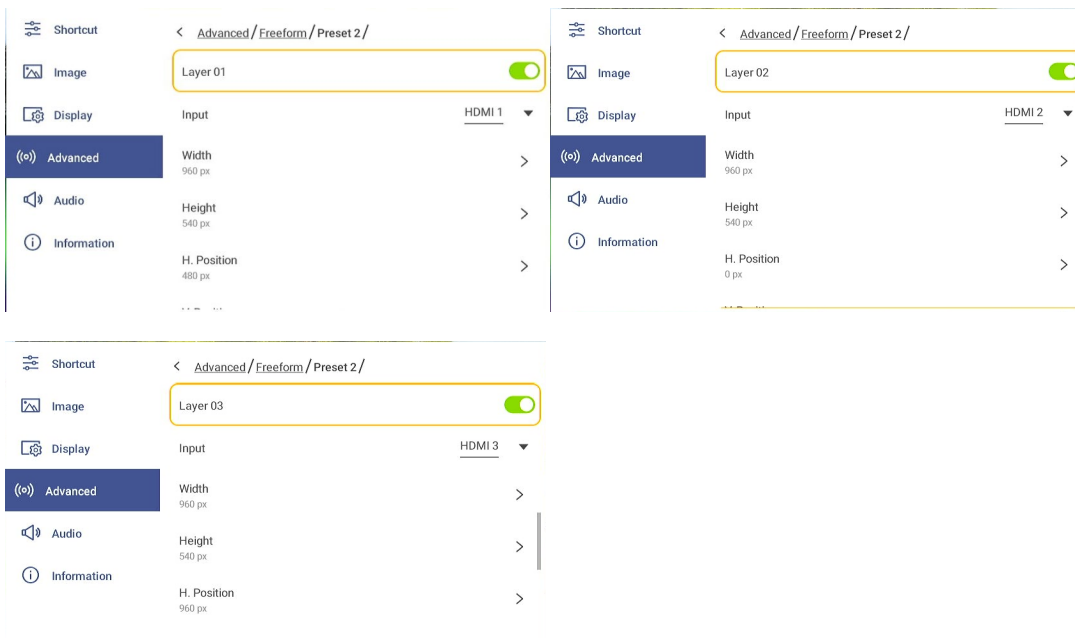

3-2. Adjust Input, Width, Height, H Position, V Position of layer 1, layer 2 and layer 3.

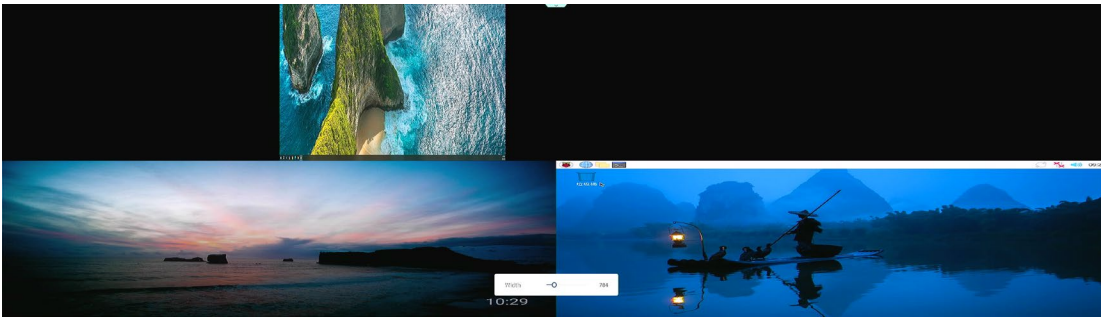

4. Customized four-layer

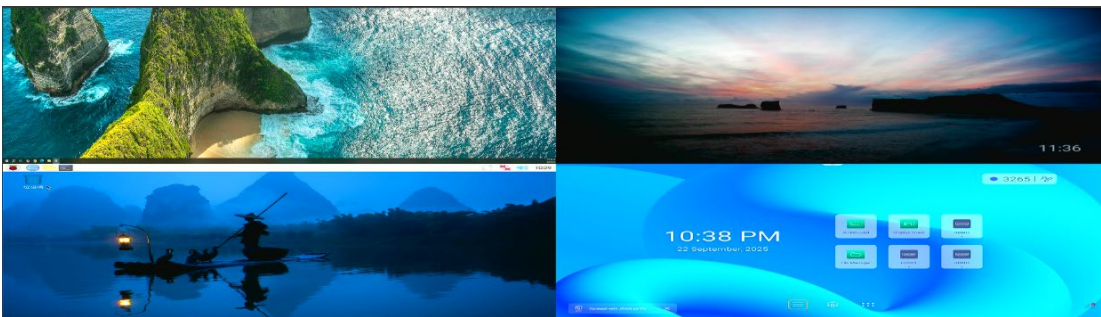

4-1. Turn on Layer 1, Layer 2, Layer 3 and Layer 4.

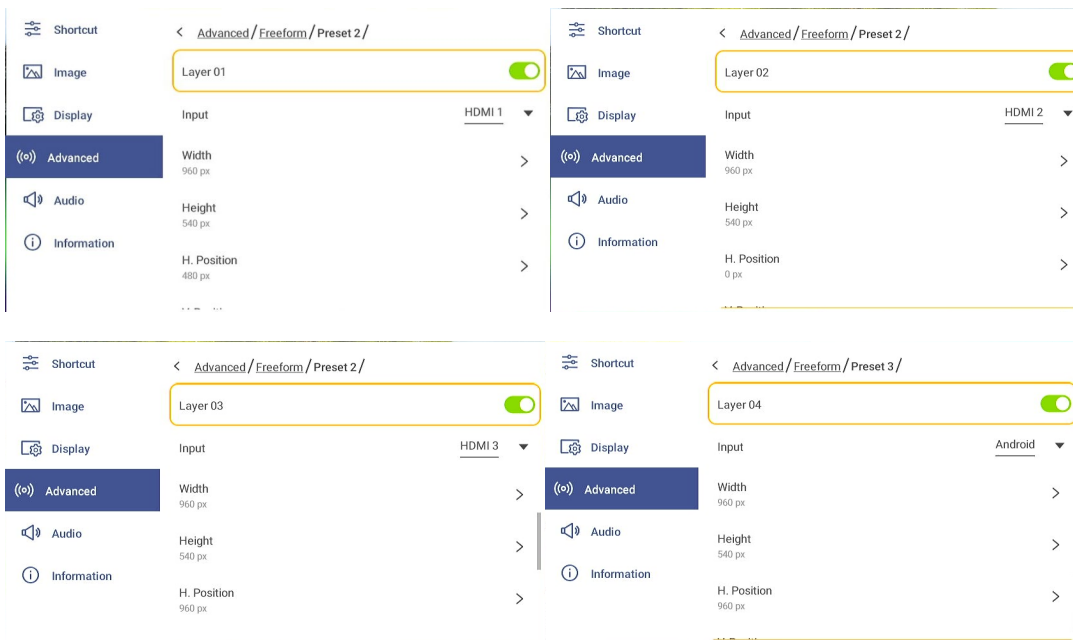

4-2. Adjust Input, Width, Height, H Position, V Position of layer 1, layer 2, layer 3 and layer 4.

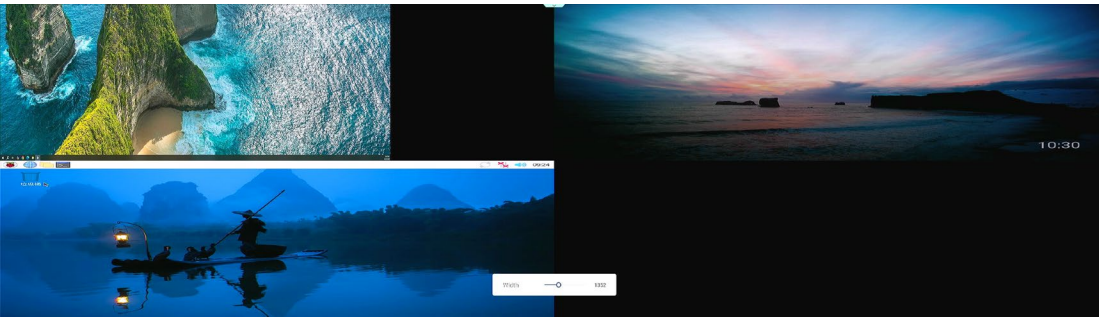

Notice:

The minimum size of layer 1 is limited to H(64), V(64), and the maximum size is full.

The size of Layer 2-4 are limited to H(64-2560)*V(64-1640).

Please note that Layer 4 will not appear immediately after configuration. You must exit the OSD menu before it becomes visible.

