

NetDirector® KVM Switches

Cat5 IP

Models:
B064-008-01-IPG
B064-016-01-IPG



Purchased product may differ from image.

Table of Contents

Table of Contents	2
Introduction	3
Important Safety Notice	3
Features	3
Remote Console Computer Requirements	4
Connected Computer/Server Requirements	4
Server Interface Units (SIUs)	4
Supported Operating Systems	4
Supported Browsers	5
Components	5
Hardware Setup	7
General Safety Instructions	7
Stacking	8
Rack Mounting	8
Single-Stage Installation	8
Two-Stage Installation	9
Laptop USB Console (LUC)	10
Hot Plugging	10
Powering Off & Restarting	10
Port ID Numbering	10
Super Administrator Setup	11
First Time Setup	11
Network Setup - IP Address Determination	11
Changing the Super Administrator Login	13
Logging Into the B064-Series KVM Switch	13
Local Console Login	13
Browser Login	14
AP Windows Client Login	14
AP Java Client Login	15
OSD Operation	16
The OSD Main Page	16
OSD Tab Bar	17
Port Access	17
User Setting and Preferences	18
Connections	19
History	23
Favorites	24
Sessions	25
Access	25
Port Configuration	26
Blade Configuration	28
User Management	29
Device Management	35
Device Information	35
Operating Mode	36
Network	36
Advanced Network Management Settings	38
OOBC	46
Security	47
Date/Time	52
Blade Server Configuration	52
Log	54
Maintenance	55
Download	58

Remote Session Operation	59
Control Panel	59
The OSD Toolbar	70
Multiuser Operation	72
Auto Scanning	72
The Log Server	73
Installation	73
Starting Up	73
The Menu Bar	73
Configure	74
Events	75
Options	76
Help	76
The Log Server Main Screen - Overview	76
Appendix	78
Keyboard Emulation	78
General Operation Troubleshooting	79
Administration Troubleshooting	80
Mouse Troubleshooting	80
Virtual Media Troubleshooting	80
AP Windows Client Troubleshooting	81
WinClient ActiveX Viewer Troubleshooting	81
Panel Array Mode Troubleshooting	82
Java Applet & AP Java Client Troubleshooting	82
Log Server Troubleshooting	82
Sun Systems Troubleshooting	83
Specifications	84
Factory Default Settings	84
Serial Adapter Pin Assignments	84
Fan Location & Speed Information	85
Temperature Sensor Location	85
Warranty	86

Introduction

Important Safety Notice



BATTERY SAFETY NOTICE

- There is a risk of explosion if the battery is replaced with an incorrect type. Dispose of used batteries according to the relevant instructions.



BATTERIE AVIS DE SÉCURITÉ

- Il existe un risque d'explosion si la batterie est remplacée par un incorrect tapez. Jeter les piles usagées selon la pertinente instructions.

Features

- Directly connect up to 8 (B064-008-01-IPG), 16 (B064-016-01-IPG) computers/servers
- Accomodate additional computers/servers in a two-level cascade installation
- Two 10/100/1000 Mbps network connections for redundant LAN or two IP operation
- Supports both IPv4 and IPv6
- Blade server support
- Supports up to 1 (B064-008-01-IPG, B064-016-01-IPG) remote sessions
- 1 Local and 1 Remote User can simultaneously access the B064-008-01-IPG, B064-016-01-IPG
- Up to 32 users can remotely share one user port
- Create up to 64 user accounts
- Multi-level authentication: super administrator; administrator; user
- Advanced security features include password protection and advanced encryption technologies - TLS 1.2 Encryption; 2048 bit RSA (encryption key up to 4096 bit); 56 bit DES; 168-bit 3DES; 256 AES; 128-bit RC4
- RJ45 connectors and Cat5e cable allow for a more efficient installation
- Browser access can be disabled – Windows® and Java GUI AP programs provided for non-browser connectivity
- Supports web-friendly access with Web Client Viewer - users can remotely access all connected servers and PCs directly off web-browsers without Java or browser plug-in installation.
- Graphical OSD and toolbars provide convenient, user-friendly operation
- Full-screen graphical OSD for the local console
- Full-screen or sizable remote desktop window; in full-screen mode the remote desktop display scales to user's monitor display size
- Panel Array Mode displays up to 32 ports at the same time
- High video resolution: up to 1920 x 1200 @ 60Hz – 24 bit color depth for the local console; up to 1920 x 1200 @ 60Hz with 24 bit color depth for remote sessions at up to 164 ft. (50 m)
- Features advanced FPGA graphics processor for improved video quality
- Multi-language support; OSD can be displayed in English, Spanish, French, German, Russian, Italian, Japanese, Korean, traditional Chinese and simplified Chinese
- Software (on-screen) keyboard
- UltraSync for USB mice – local and remote mouse movement are the same – no need to constantly re-sync the two movements
- Windows-based Log Server
- Support all major server platforms and VT100-based serial devices
- Support multi-platform server environments: PS/2 and USB
- Support 10Base-T, 100Base-T, 1000Base-T, Auto-Sense, TCP/IP, HTTP, DNS, DHCP, UDP, ARP, Ping
- Remote authentication support: RADIUS, LDAP, LDAPS, and Active Directory
- Flash upgradeable firmware over the network
- Server Interface Unit (SIU) information is stored by the KVM switch. When switched to a different port, the port settings (Port OS, OS Language, etc.) for the SIU are transferred along with it
- Virtual Media allows computers connected to the KVM switch by a B055-001-USB-V2 SIU to access DVD/CD drives, flash drives and other storage media as if they were directly connected to the computer (works in either the operating system or BIOS level)
- Includes three USB ports on the front of the unit that can be used for an external keyboard and mouse or for virtual media functionality
- Dual power supplies allow the unit to continue running in the event one power supply ceases to receive power. If one power supply fails, the other powers supply takes over to keep the unit powered and functional.
- Temperature sensors determine if fans are needed to cool the device and at what speed. The fan speed increases/decreases along with the temperature, using energy more efficiently and increasing the life of the fans and switch.
- Track critical events on the installation via SMTP email notification, SNMP traps, the included Windows-based Log Server or Syslog server
- Users can choose between any combination of 56-bit DES, 168-bit 3DES, 256-bit AES, 128-bit RC4 or Random for independent Keyboard/Mouse, video and virtual media data encryption
- Support Exit Macros
- BIOS level access
- Supports *Link Local IPv6 Address* and *IPv6 Stateless Autoconfiguration* protocols
- Modem out of band Dial In, Dial Out, Dial Back support
- Automated Certificate Signing Request (CSR) creation utility
- Supports importing third party CA certificates
- Supports IPS 140-2 level 1 security standards
- Local monitor's EDID information stored in connected Server Interface Units (SIUs) for optimal display resolution

Introduction

Remote Console Computer Requirements

- Browsers must support TLS 1.2 Encryption
 - For the browser-based Java Applet and non-browser AP Java Client, the latest version of Sun's Java Runtime Environment (JRE) must be installed, and 250 MB of memory available after installation
 - For the Log Server, you must have the Microsoft Jet OLEDB 4.0 or higher driver installed
 - For best results, we recommend computers used to access the switch have at least a Pentium 4, 2 GHz processor and at least 1 GB RAM with a minimum screen resolution set to 1024 x 768 processor, with their screen resolution set to 1024 x 768
- For best results, a network transfer speed of at least 512 kbps is recommended
 - For the browser-based Windows Client, DirectX 8 must be installed, and at least 150MB of memory available after installation
 - For the non-browser AP Windows client, DirectX 8 must be installed, and at least 90MB of memory available after installation
 - Multi-browser support: Internet Explorer, Chrome, Firefox, Safari, Opera, Netscape

Connected Computer/Server Requirements

Computers/servers to be connected to the B064-Series KVM Switch must have the following:

- VGA, SVGA or Multisync port
- For USB Server Interface Unit Connections: Type A USB port and USB host controller
 - For PS/2 Server Interface Unit Connections: 6-pin mini-DIN keyboard and mouse ports

Server Interface Units (SIUs)

Cat5e/6 cable is required to connect the B064-Series KVM Switches to one of the Server Interface Units (SIUs). The following SIUs are required for use with the B064 Series KVM Switch:

Function	SIU
Connect to a computer/server with PS/2 ports – 164 ft. (50 m) Max Distance	B054-001-PS2
Connect to a computer/server with PS/2 ports – 164 ft. (50 m) Max Distance	B055-001-PS2
Connect to a computer/server with USB ports – No Virtual Media Support; 164 ft. (50 m) Max Distance	B054-001-USB
Connect to a computer/server with USB ports – No Virtual Media Support; 164 ft. (50 m) Max Distance	B055-001-USB
Connect to a Sun computer/server with USB ports – 164 ft. (50 m) Max Distance	B054-001-SUN
Connect to a computer/server with USB ports – Supports Virtual Media; 164 ft. (50 m) Max Distance	B055-001-USB-V2
Connect to a serial based device – 492 ft. (150 m) Max Distance	B055-001-SER

Note: SIUs that were purchased prior to that of your KVM switch may require a firmware upgrade in order for them to work properly (see Maintenance under OSD Operation section for details).

Supported Operating Systems

Supported operating systems for computer/servers that connect to the B064-Series KVM switches are shown in the table at right:

Supported operating systems for users that remotely log into the B064-Series KVM Switches include Windows XP and higher, and those capable of running Sun's Java Runtime Environment (JRE) 6, Update 3, or higher.

OS	Version
Windows	XP and higher
Linux® Red Hat	7.1 and higher
Linux Fedora	Core 2 and higher
Linux SuSE	9.0 and higher
Linux Mandriva	9.0 and higher
UNIX® AIX	4.3 and higher
UNIX FreeBSD	4.2 and higher
UNIX Sun	Solaris 8 and higher
Novell® Netware®	5.0 and higher
Mac®	OS 9 and higher
DOS	6.2 and higher

Introduction

Supported Browsers

Supported browsers for users that remotely log into the B064-Series KVM Switches include:

Browser	Version
Internet Explorer®	8 and higher
Firefox®	3.5 and higher
Mozilla®	1.7 and higher
Safari®	4.0 and higher
Opera®	10.0 and higher
Netscape Navigator®	9.0 and higher

Components

Front View (B064-016-01-IPG)

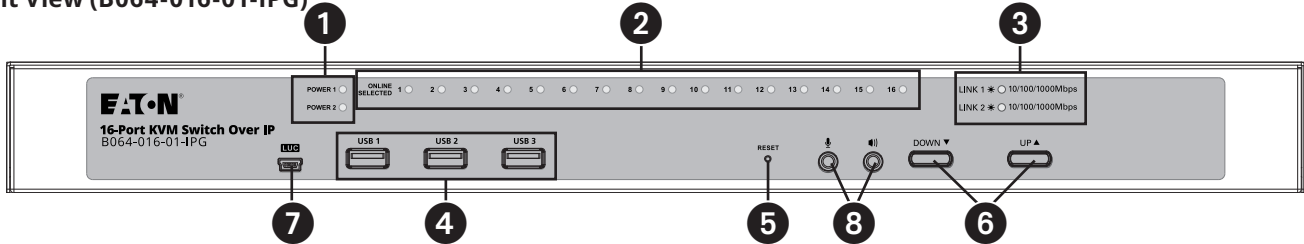

No. Component

- 1 Power LEDs
- 2 Port LEDs
- 3 LAN LEDs
- 4 USB Ports
- 5 Reset Button
- 6 Port Switching Buttons
- 7 Laptop USB Console (LUC) Port
- 8 Audio Ports

Description

Depending on which power supply is providing power, the POWER 1 or POWER 2 LED will illuminate when the KVM switch is turned on.

Port LEDs will illuminate in colors corresponding to the status of the port:

- Green** – Illuminate green when the corresponding port is connected and powered-on
- Red** – Illuminate red when the corresponding port is selected as having the KVM's focus, but is either not connected to a computer/server or is connected to a computer/server that is not powered-on
- Orange** – Illuminate orange when the corresponding port is connected, powered-on and selected as having the KVM's focus

Note: The Port LEDs are steady under normal conditions, but will flash at half second intervals when the corresponding port is being accessed under Auto Scan Mode or Skip Mode.

The Primary (Link 1) and Secondary (Link 2) LAN LEDs will illuminate in colors corresponding to the network transfer rate:

- Red** – Illuminate red at speeds of 10 Mbps
- Orange** – Illuminate orange at speeds of 100 Mbps
- Green** – Illuminate green at speeds of 1000 Mbps

Note: Only computers connected to the KVM by a B055-001-USB-V2 can access the KVM's Virtual Media functionality.

Additional USB ports support external keyboard and mouse, as well as virtual media functionality.

Note: This recessed button must be pushed with a thin object, such as the end of a paper clip or a ballpoint pen.

- Pressing and releasing the Reset Button when the KVM switch is running performs a system reset.
- Pressing and holding the Reset Button in for more than three seconds when the KVM switch is running resets the switch configuration to the factory default settings. Note: This does not clear User Account information.
- Pressing and holding the Reset Button in while powering on the switch will restore the KVM switch to its original firmware in the event of a firmware upgrade failure. Note: This operation should only be performed in the event of a firmware upgrade failure that results in the device becoming inoperable.

- Press the **Port Down** button to switch from the current port to the previous port on the installation.
- Press the **Port Up** button to switch from the current port to the next port on the installation.

A USB port that allows for direct connection of a laptop to the switch for easy console operation.

Speakers and microphone plug in here.

Introduction

Components

Rear View (B064-016-01-IPG)

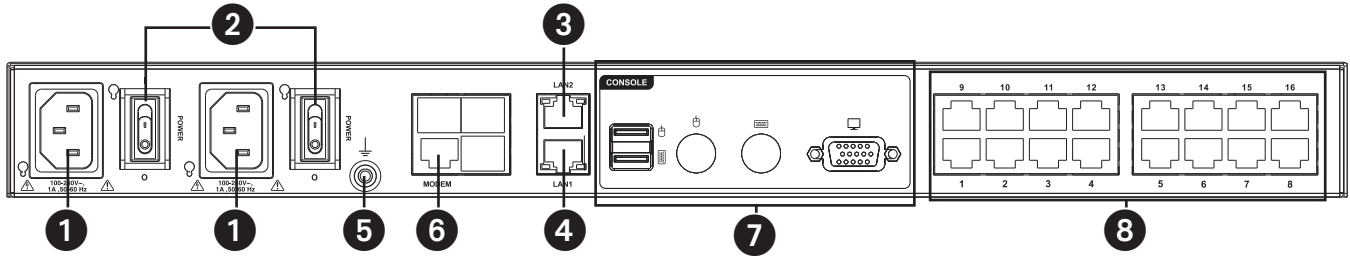

No. Component

Description

- 1** Power Sockets (C14) The two C14 power sockets are located here. Connect the included power cords (C13 to C14) from here to an appropriate power source.
Note: To help protect your system from sudden transient increases and decreases in electrical power, it is recommended that you plug your devices into an Eaton Tripp Lite series surge protector, line conditioner or uninterruptible power supply (UPS).
- 2** Power Switches The On/Off switches for the two power supplies are here.
- 3** Secondary LAN Port (LAN 2) The cable that connects the KVM switch to the backup network plugs in here.
- 4** Primary LAN Port (LAN 1) The cable that connects the KVM switch to the primary network plugs in here.
- 5** Grounding Terminal Connect the included grounding wire to this terminal to ground the KVM switch.
- 6** Modem Port An optional dial-in connection is available for use in the event the KVM switch is not available over the Primary or Secondary networks.
- 7** Local Console Ports This area features VGA port for the connection of either a VGA monitor, as well as two USB ports and two PS/2 ports for the connection of a keyboard and mouse.
- 8** Server Ports Cat5e/6 cable connects between these ports and the SIUs to connect computer/servers to the KVM switch.

Hardware Setup



WARNING

Class I Equipment. This equipment must be earthed. The power plug must be connected to a properly wired earth ground socket outlet. An improperly wired socket outlet could place hazardous voltages on accessible metal parts.



AVERTISSEMENT

Équipement de classe I. Cet équipement doit être mis à la terre. La fiche d'alimentation doit être connectée à une prise de courant mise à la terre correctement câblée. Une prise de courant incorrectement câblée pourrait introduire des tensions dangereuses sur des pièces de métal accessibles.

62368-1 Clause Equipment for Installation:

Suitable for installation in Information Technology Rooms in accordance with Article 645 of the National Electrical Code and NFPA 75. Peut être installé dans des salles de matériel de traitement de l'information conformément à l'article 645 du National Electrical Code et à la NFPA 75.

- Read all of these instructions. Save them for future reference.
- Follow all warnings and instructions marked on the device.
- Use of this equipment in life support applications where failure of this equipment can reasonably be expected to cause the failure of the life support equipment or to significantly affect its safety or effectiveness is not recommended. Do not use this equipment in the presence of a flammable anesthetic mixture with air, oxygen or nitrous oxide.
- This device is designed for IT power distribution systems with up to 230V phase-to-phase voltage.
- Do not place the device on any unstable surface (cart, stand, table, etc.). If the device falls, serious damage will result.
- Do not use the device near water.
- Do not place the device near, or over, radiators or heat registers.
- The device cabinet is provided with slots and openings to permit adequate ventilation. To ensure reliable operation and protect against overheating, these openings must never be blocked or covered.
- The device should not be placed on a soft surface (bed, sofa, rug, etc.), as this will block its ventilation openings. Likewise, the device should not be placed in a built-in enclosure unless adequate ventilation has been provided.
- Never spill liquid of any kind on the device.
- Unplug the device from the wall outlet before cleaning. Use a damp cloth for cleaning. Do not use liquid or aerosol cleaners.
- The device should be operated from the type of power source indicated on the marking label. If you are not sure of the type of power available, consult your dealer or local power company.
- To prevent damage to your installation, ensure that all devices are properly grounded.
- The device is equipped with a 3-wire grounding type plug. This is a safety feature. If you are unable to insert the plug into the outlet, contact your electrician to replace your obsolete outlet. Do not attempt to defeat the purpose of the grounding-type plug. Always follow your local/national wiring codes.
- Position system cables and power cables carefully to ensure that nothing rests on any cable. Route the power cord and cables so that they cannot be stepped on or tripped over.
- If an extension cord is used with this device, make sure that the total ampere rating of all products used on the cord does not exceed the extension cord ampere rating. Make sure that the total of all products plugged into the wall outlet does not exceed 15 amperes.
- To help protect your system from sudden transient increases and decreases in electrical power, it is recommended that you plug your devices into a surge protector, line conditioner, or uninterruptible power supply (UPS).
- When connecting or disconnecting power to hot-pluggable power supplies, observe the following precautions:
 - > Install the power supply before connecting the power cable to the power supply
 - > Unplug the power cable before removing the power supply
 - > If the system has multiple sources of power, disconnect power from the system by unplugging all power cables from the power supplies
 - > Never push objects of any kind into or through cabinet slots. They may touch dangerous voltage points or short out parts, resulting in a risk of fire or electrical shock
 - > Do not attempt to service the device yourself. Refer all servicing to qualified service personnel
- If the following conditions occur, unplug the device from the wall outlet and bring it to qualified service personnel for repair:
 - > The power cord or plug has become damaged or frayed
 - > Liquid has been spilled into the device
 - > The device has been exposed to rain or water
 - > The device has been dropped or the cabinet has been damaged
 - > The device exhibits a distinct change in performance, indicating a need for service
 - > The device does not operate normally when the operating instructions are followed

Hardware Setup

- Adjust only those controls that are covered in the operating instructions. Improper adjustment of other controls may result in damage that will require extensive repair work by a qualified technician.
- Do not connect the RJ11 connector marked “UPGRADE” to a public telecommunication network.

Rack Mounting Safety Instructions

- Before working on the rack, make sure that the stabilizers are secured to the rack, extended to the floor, and that the full weight of the rack rests on the floor. Install front and side stabilizers on a single rack or front stabilizers for joined multiple racks *before* working on the rack.
- Always load the rack from the bottom up, and load the heaviest item in the rack first.
- Make sure that the rack is level and stable before extending a device from the rack.
- Use caution when pressing the device rail release latches and sliding a device into or out of a rack; the slide rails can pinch your fingers.
- After a device is inserted into the rack, carefully extend the rail into a locking position, and then slide the device into the rack.
- Do not overload the AC supply branch circuit that provides power to the rack. The total rack load should not exceed 80 percent of the branch circuit rating.
- Make sure that all equipment used on the rack, including power strips and other electrical connectors, is properly grounded.
- Ensure that proper airflow is provided for devices in the rack.
- Ensure that the operating ambient temperature of the rack environment does not exceed the maximum ambient temperature specified for the equipment by the manufacturer.
- Do not step on or stand on any device when servicing other devices in a rack.

Stacking

The KVM switch can be placed on any level surface that can safely support its weight plus the weight of attached cables. When placing the KVM switch on a desktop, remove the backing material from the rubber feet that came with this package and affix them to the switch's bottom panel at the corners.

Note: To ensure adequate ventilation, allow at least 2 inches (5 cm) on each side, and 5 inches (13 cm) at the back for power cord and cable clearance.

Rack Mounting

The KVM switch can be mounted in a 19-in (1U) rack. The rack mount brackets can be installed on either the front or the back of the unit so that it can be mounted to the front or back of the rack.

1. Depending on whether you front-rack mount or rear-rack mount the unit, remove the two screws located on both sides of the front or back of the unit.
2. Use the screws supplied with the rack mount kit to attach the rack mount brackets to the front or rear of the unit.
3. Position the device in the front or rear of the rack and align the holes in the mount brackets with the holes in the rack.
4. Secure the rack mount brackets to the rack using user-supplied screws.



Use user supplied hardware to attach to the rack

Use the M3x8 Phillips head hex screws provided with the rack mount kit

Single-Stage Installation

In a single-stage installation, there are no additional KVM switches cascaded or daisy-chained from the B064-Series KVM. To set up a single-stage installation, refer to the following instructions and the corresponding installation diagrams.

1. Make sure that power to all the devices you will be connecting, including all pre-existing devices on the installation, have been turned off.
2. **Optional:** Plug your Local Console's keyboard, monitor, and mouse into the KVM's Local Console Ports.
3. Use Cat5e cable to connect any available KVM port to a Server Interface Unit (SIU). See the chart in the *Server Interface Unit* section to determine the appropriate SIU.
4. Connect the Server Interface Unit to the computer/server.
5. Connect a Cat5e cable from the network into the KVM switch's primary network port (LAN 1).
6. **Optional:** Connect a second Cat5e cable from the network into the KVM switch's backup (secondary) network port (LAN 2).
7. **Optional Dial-In Modem Connection:** Use Cat5e cable to connect the KVM switch's Modem port.

Hardware Setup

Single-Stage Installation

- Use the included grounding wire to ground the unit. Connect one end of the wire to the grounding terminal, and the other end of the wire to a suitable grounded object.
- Plug the included power cords into the KVM switch's Power Sockets, and then into a Surge Protector, Uninterruptible Power Supply (UPS) or PDU.
- Turn on the power to the KVM switch. Once it is powered up, turn on the power to the connected computers.

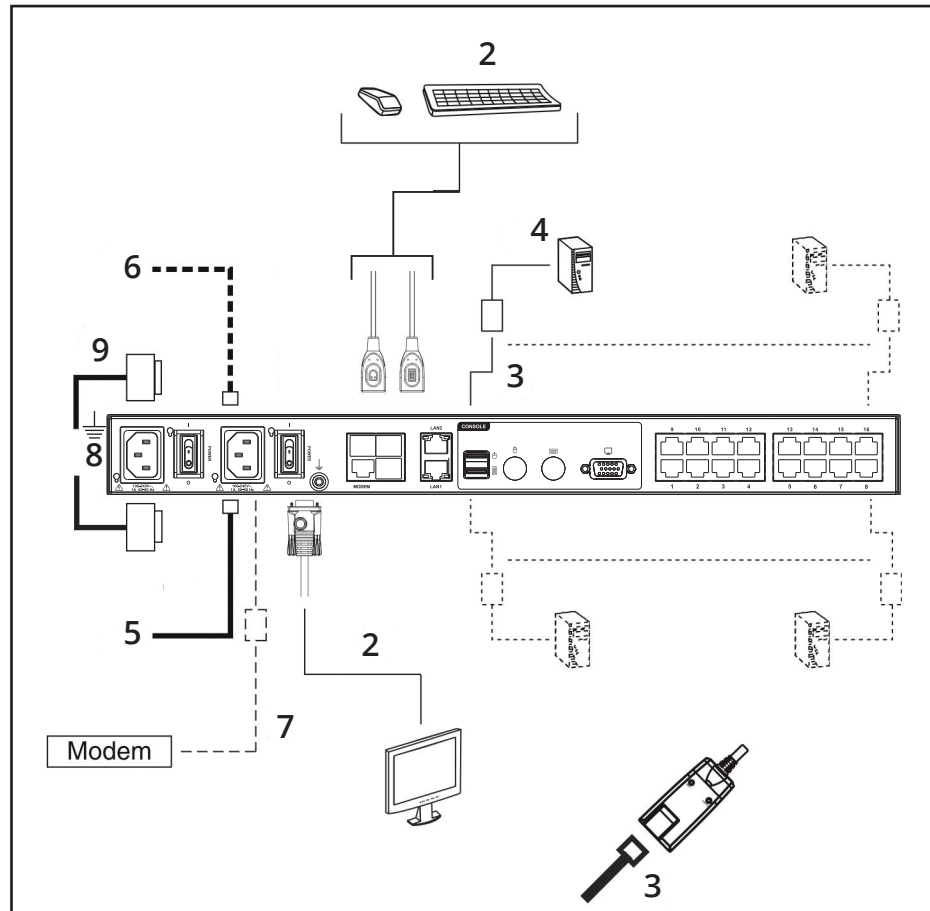

Two-Stage Installation

Up to 32 additional B064-016 KVM switches can be cascaded from your unit's KVM ports, expanding the number of connected computers/servers up to 256. In a cascaded installation, the top KVM Switch is considered the first-stage unit, the cascaded switches are considered second-stage units.

To set up a two-stage installation:

- Ensure that power to all the devices you will be connecting, including all pre-existing devices on the installation, have been turned off.
- Use Cat5e/6 cabling to connect an available KVM port on the first-stage unit to a B054-001-PS2 or B055-001-PS2 SIU.

Note: Although USB SIUs will allow you to cascade to a second-stage KVM, only PS/2 SIUs will properly display the cascaded KVM in the OSD. When connected via PS/2 SIU, the cascaded KVM will be displayed as an expandable port, allowing you to easily access the connected computers. When connected via USB SIU, the cascaded KVM will be displayed as an ordinary port. To access computers connected to the KVM, you will have to use the cascaded KVMs OSD.

- Plug the SIU's KVM connectors to the Keyboard, Video, and Mouse Console ports of the second-stage B064-016 unit.

Note: The distance between the second-stage unit and the first-stage Unit cannot exceed 164 ft. (50 m).

- Use the appropriate KVM Cable Kits (See the Second Stage KVMs owner's manual), to connect any available KVM port on the second-stage unit to the Keyboard, Video and Mouse ports of the computer/server you are installing.

Hardware Setup

Two-Stage Installation

5. Plug the power cord that came with the cascaded KVM switch into its power socket, and then into a Surge Protector, Uninterruptible Power Supply (UPS) or PDU.
6. Repeat these steps for any other second-stage units you wish to connect.
7. First power on the first-stage KVM Switch and then power on all second-stage KVM switches.
8. Turn on the power to all of the connected computers/servers.

Note: The Power On sequence requires that the first-stage KVM Switch be powered on first. After the first-stage KVM Switch has been powered on, all second-stage units must be powered on. After the second-stage units have been powered on, the connected computers/servers can be powered on.

Laptop USB Console (LUC)

The front panel of the KVM switch features a USB Micro-B port, which connects to the USB port on a laptop, to provide console control of the KVM switch. To use this feature, connect your laptop to the LUC port on the front of the KVM using a USB Micro-B cable. When connected, an extra drive will appear in your computer's My Computer screen. Click on this drive to bring up the Windows and Java Non-Browser Clients. Run the desired client to access the KVM switch. The client's login screen will appear, with the KVM showing up as a USB Mass Storage device in the Login Screen's Server List. Highlight the KVM and then connect per the instructions in the *AP Windows Client Login* and/or *AP Java Client Login* sections of this manual.

Hot Plugging

The B064-Series KVM Switches support hot plugging: components can be removed and added back into the installation by unplugging and replugging their cables from the ports without the need to shut the unit down. The KVM also includes an Adapter ID function that stores the port settings of the SIU (Port OS, OS Language, etc.), allowing you to switch an SIU and its connected computer to a new port without having to re-enter its port settings. The settings are stored by SIU only; therefore, the correct settings will not transfer if you change the computer connected to the SIU. Also, the Adapter ID function only applies when switching to ports on the same KVM switch.

Powering Off & Restarting

If it becomes necessary to power off the B064-Series KVM Switch, or the switch loses power and needs to be restarted, wait 10 seconds before powering it back on. Connected computers should not be affected by this but if any of them should fail, simply restart them.

Port ID Numbering

Each computer on the installation is assigned a unique Port ID. The Port ID is a one or two segment number that is determined by the Stage Level and KVM port number of the KVM switch to which the computer/server is connected.

Single-Stage Installations

Single-stage installations will have a one segment Port ID consisting of two digits.

Two-Stage Installations

Two-stage installations will have a two segment Port ID consisting of 4 digits. (2 digits per segment)

- The first segment of the Port ID represents the port number of the first-stage KVM switch to which the cascaded unit is connected.
- The second segment of the Port ID represents the port number of the second-stage KVM switch to which the computer/server is connected.

(For example, a computer attached to port 3 of a second-stage KVM switch that is connected to port 15 of the first-stage KVM switch will have a Port ID of 03-15)

Super Administrator Setup

The B064-Series KVM Switchs supports three types of users:

User Type	Description
Super Administrator	Super Administrators have full access to all Ports and Devices in the KVM installation. They can manage all aspects of the installation.
Administrator	Administrators have access to Ports and Devices that are authorized by the Super Administrator. They can manage Users and Groups and configure their personal working environment.
User	Users can access Ports and Devices authorized by Super Administrators or Administrators and they can configure their personal working environment.

First Time Setup

Once the B064-Series KVM Switch has been installed, the Super Administrator must prepare the unit up for user operation by setting the network parameters and adding users.

Network Setup - IP Address Determination

If you are an administrator logging in for the first time, you must access the B064-Series KVM Switch in order to give it an IP address to which users can connect. B064-Series KVM switches support both standard IPv4 and IPv6. There are three methods of doing this: *Local Console*, *IP Installer* and *Browser*.

1. Local Console

After the local console has been connected and the B064-Series KVM Switch is turned on, a login prompt appears on the console monitor:

B064-016-01-IPG Login

Username

Password

Log in using the default Username: *administrator* and Password: *password*. For security purposes, it is strongly recommended that you change these to a unique Username and Password. (See *Changing the Super Administrator Login* section for instructions.)

After you successfully log in, the *Local Console Main Screen* appears:

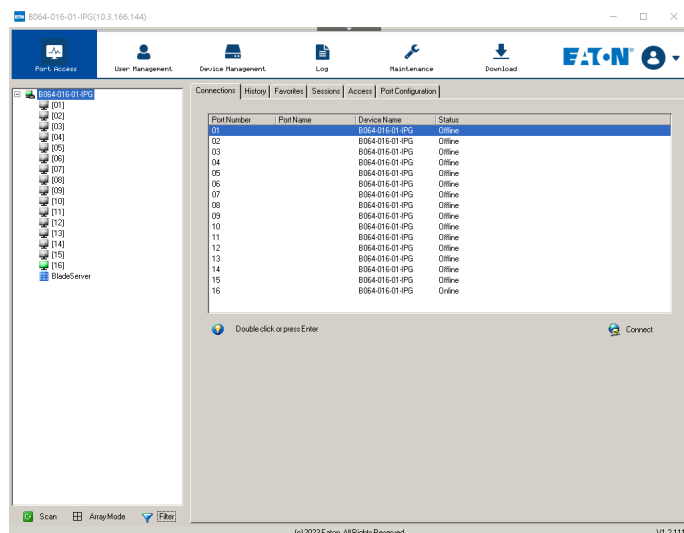

1. Click the Device Management icon at the top of the screen.
2. On the screen that appears on the right-hand side of the page select the Network tab.

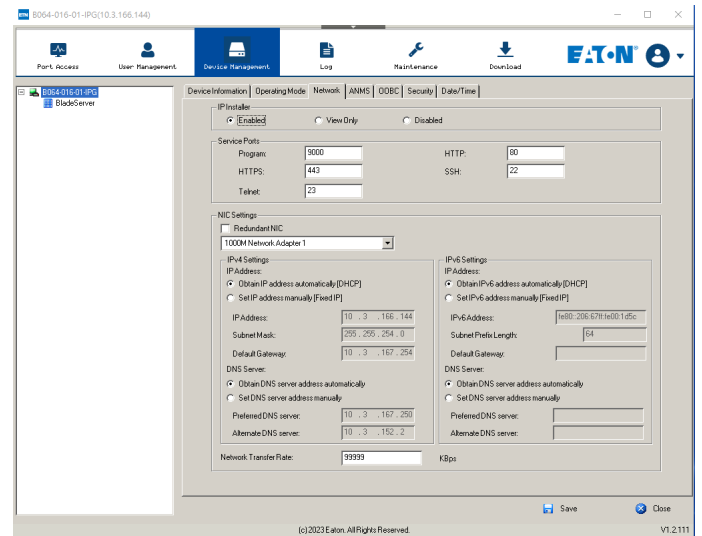

Super Administrator Setup

Network Setup - IP Address Determination

NIC Settings

The B064-Series KVM Switch has two network interfaces. The NIC Setting section of the Network tab allows you to assign a single IP Address and DNS Server for both network interfaces, or to assign a separate address for each.

Redundant NIC

If Redundant NIC is enabled (the default), both interfaces use the IP address assigned to Network Adapter 1. Under this configuration, the B064-Series KVM Switch will switch to the second network interface in the event there is a crash on the first network interface.

- If you select Redundant NIC, the *Network Interface* drop-down menu will be frozen to Network Adapter 1, and you will only have to enter IP Address and DNS Server settings once.
- If you do not select Redundant NIC, you will have to enter IP Address and DNS Server settings for both Network Adapter 1 and Network Adapter 2. Use the *Network Interface* drop-down menu to select the Network Adapter you want to configure.

IP Address and DNS Server Address

The B064-Series KVM switch supports both IPv4 and IPv6 addresses. The *Network* page allows you to set the IP address manually, or to select to have it automatically assigned via DHCP server. By default, the IP address is set to be assigned automatically via DHCP server.

- To have the IP address assigned by your DHCP server, check the *Obtain IP address automatically (DHCP)* check box in the IPv4 or IPv6 settings section, depending on your network.
- To assign an IP address yourself, check the *Set IP address manually* check box in the IPv4 or IPv6 settings section, depending on your network. When checked, the IP address and DNS server address fields open up, allowing you to enter in the desired settings. Once you have entered in all the IP address and DNS server address information, click the *Save* button at the bottom of the screen. Upon logging out of the KVM (click the *Logout* icon in the upper-right corner of the OSD), the KVM will reset itself and the IP address settings you just entered will be implemented.

Note: When manually assigning a DNS Server address, it is required that you enter the Preferred DNS server, but the Alternate DNS server is an optional field.

See *Network* section under *Device Management* for more information on these settings.

2. IP Installer

For computers running Windows, an IP address can be assigned with the IP Installer utility:

Note: In order to use the IP Installer, the *IP Installer Enabled* check box in the *Network* page must be checked. (See *Network* section under *Device Management in OSD Operation for details*.) By default, the *IP Installer View Only* check box is checked, allowing you to view the KVMs IP Address using the IP Installer but not change it.

1. Obtain the IP Installer file from the CD that came with the B064-Series KVM Switch and save it to a desired location on a computer that is on the same network as your B064-Series KVM Switch.

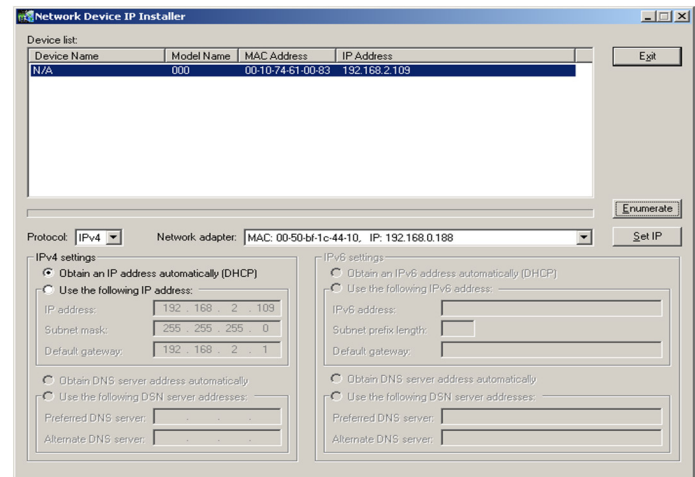

2. Go to the IP Installer file that you just saved and run the IPInstaller.exe file.

3. Select the B064-Series KVM Switch in the Device List.

Note: If the list is empty, or your device doesn't appear, click *Enumerate* to refresh the Device List. If there is more than one device in the list, use the MAC address to pick the one you want. The B064-Series KVM Switches MAC address is located on its bottom panel.

4. From here you can choose to *Obtain an IP address automatically (DHCP)*, or *Specify an IP address*. If you choose to assign your own address, fill in the *IP Address*, *Subnet Mask*, and *Gateway* fields with information appropriate to your network.

5. Click *Set IP*.

6. After the IP address shows up in the Device List, click *Exit*.

3. Browser

By default, the KVM switch is set to have its IP address assigned automatically via DHCP server. If the KVM is connected to a network without a DHCP server, it boots with a default IP address. On IPv4 networks, the default IP is 192.168.0.60. If the KVM is on an IPv6 network, the default IP address is determined by the KVMs MAC address. For example, if the KVM has a MAC address of 00-10-74-13-81-01, the IPv6 address is **FE80:0:0:0:0010:74FF:FE13:8101**. The parts of the IP address that are bolded and underlined are fixed.

1. Access the B064-Series KVM switch by using the default URL mentioned above.
2. Assign a fixed IP address for the KVM using the same instructions as described in the *Local Console* section of this chapter.

Super Administrator Setup

Changing the Super Administrator Login

To change the default Super Administrator Username and Password, do the following:

1. At the top of the OSD page, click *User Management*.

Since this is the first time the page is being accessed, only the Super Administrator appears:

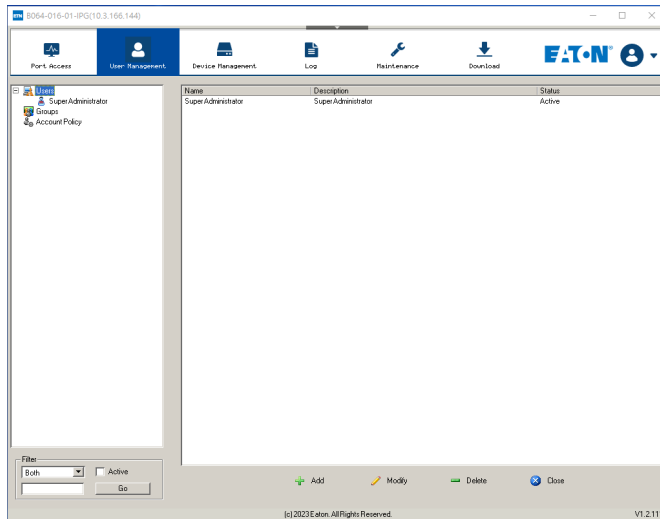

2. Click Administrator in the left panel; or, select Administrator in the central panel and click the Modify button at the bottom of the page.

A screenshot of the 'User Information' dialog box. It contains the following fields and options:

- Username:** Super Administrator
- Password:** [Redacted]
- Confirm Password:** [Redacted]
- Description:** Super Administrator
- Role:** Radio buttons for Super Administrator (selected), Administrator, and User.
- Permissions:** A grid of checkboxes for various functions: Device Management, Maintenance, Windows Client, Telnet Client, Port Configuration, System Log, Java Client, Force to Grayscale, User Management, View only, and SSH Client. Most are checked.
- Status:** A section with checkboxes for account settings: Disable account, Account never expires (selected), Account expires on [Date field], User must change password at next logon, User cannot change password, Password never expires (selected), and Password expires after [30] days.

The *User Information* page appears:

3. Change the Username and Password to something unique.
4. Re-enter the password to confirm it is correct.
5. Click Save.
6. When the dialog box informing you that the change completed successfully appears, click OK.

Logging Into the B064-Series KVM Switch

The B064-Series KVM Switches can be accessed in the following ways: via local console, an internet browser, the AP Windows Client and/or the AP Java Client. Operating the KVM switch and configuring its settings is done the same regardless of how you connect to the B064-Series KVM Switch; the only difference is the way in which you establish the connection. This chapter describes the login procedures for each of these methods.

Local Console Login

The local console login dialog box is displayed once the installation is complete. Simply key in your Username and Password and click Login to bring up the OSD Main Page.

Note: If you supply an invalid login, the authentication routine will return an *Invalid Username or Password* message. If you see this message, log in again being careful to enter the correct Username and Password.

Logging Into the B064-Series KVM Switch

Browser Login

The B064-Series KVM Switches can be accessed via Internet browser from any platform that has the Java Runtime Environment 6, Update 3, or higher installed. If you don't already have the required JRE installed, it is available for free download from the Java web site: www.java.com

Note: Windows 7 users must run Internet Explorer as an administrator for the Active X control to work properly. If you don't run Internet Explorer as an administrator, you will not be able to access the connected computers.

To access the switch via browser, do the following:

1. Open the browser and specify the IP address of the B064-Series KVM Switch you want to access, as given to you by your system administrator.

Note: For security purposes, a login string may have been set by the administrator. If so, you must include a forward slash and the login string along with the IP address when you log in. (For example, a computer with a login string of B064-016-01-IPG would have a URL such as 192.168.0.100/B064-016-01-IPG)

2. When you try to log into the device from your browser, a Security Alert message appears to inform you that the device's certificate is not trusted, and asks if you want to proceed. The certificate can be trusted, but the alert is triggered because the certificate's name is not found on Microsoft's list of Trusted Authorities.

You have two options:

- If you are working on a computer other than your own, accept the certificate for just this session by clicking Yes.
- If you are working at your own computer, install the certificate. After the certificate is installed, it will be recognized as trusted. To install the certificate, do the following:
 - a) In the Security Alert dialog box, click *View Certificate*. The Certificate Information dialog box appears.**Note:** You may need to run Internet Explorer as an Administrator in order to view and install the certificate.
 - b) Click *Install Certificate*.
 - c) Follow the Installation Wizard to complete the installation. Unless you have a specific reason to choose otherwise, accept the default options.
 - d) When the Wizard presents a caution screen, click *Yes*.
 - e) Click *Finish* to complete the installation and click OK to close the dialog box. The certificate is now trusted.

Upon installing the certificate or accepting the unrecognized certificate for the current session, the browser login dialog box appears.

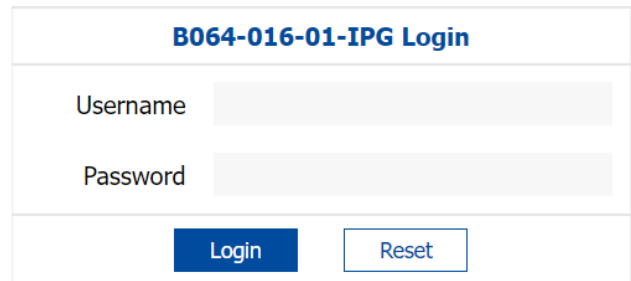

3. Provide a valid Username and Password (set by the KVM switch's administrator), and click *Login* to bring up the OSD Main Page.

Note: If you supply an invalid login, the authentication routine will return an *Invalid Username or Password* message. If you see this message, log in again being careful to enter the correct Username and Password.

AP Windows Client Login

In some cases, the Administrator may not want the B064-Series KVM Switches to be available via browser. The Windows AP Client allows Windows systems users access to the KVM switch without having to go through a browser.

The AP Windows Client can be found in the Download Section of the OSD. If browser access to the KVM switch has already been disabled, you will need to obtain the file from your system administrator. Once you have saved the AP Windows Client, go to its location and double-click the *WinClient.exe* icon to bring up the Windows Client Connection Screen.

Note: If you have trouble opening the AP Windows Client, save it to your desktop and try again.

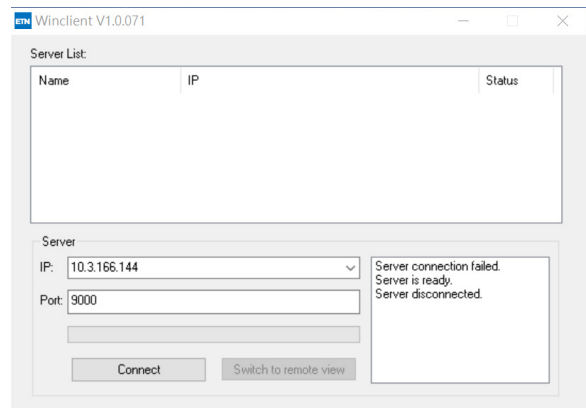

Logging Into the B064-Series KVM Switch

AP Windows Client Login

The Connection Screen

A description of the contents of the Connection Screen is given in the following table:

Item	Description
Menu Bar	The Menu Bar contains two menus; File and Help. The File Menu allows the operator to Create, Save, and Open Work files.
Server List	Each time the WinClient.exe file is run, it searches the User's LAN segment for B064-Series KVM Switches, and lists the ones it finds in this box. Double-click on any of the units in this list to connect to it. Note: For a switch to show up in the Server List, the Enable Device List check box in the Operating Mode page (see Operating Mode section under Device Management in OSD Operation for details) must be checked and the Program service port in the Network page (see Network section under Device Management in OSD Operation for details) must be set to the same number as in the AP Windows Client Port field.
Server	This area is used when you want to connect to a B064-Series KVM Switch at a remote location. <ul style="list-style-type: none">Click on the IP drop-down and select an address from the list. If the address you want is not listed, key in the target IP address in the IP field, and its port number in the Port field.When the IP address and port number have been specified, click Connect to bring up a login dialog box. Provide a Username and Password as provided by your system administrator and click OK to establish a connection with the B064-Series KVM Switch.When you have finished with your session, click Disconnect to end the connection.
Message List	Lists status messages regarding the connection to the B064-Series KVM Switch.
Switch to Remote View	Once a remote connection with a B064-Series KVM Switch has been established, this button becomes active. Click it to switch to the KVM Switch's Main OSD Page.

AP Java Client Login

In those cases in which the Administrator does not want the B064-Series KVM Switch to be available via browser and the remote user is not running Windows, the AP Java Client provides access to the KVM switch.

After downloading the AP Java Client, go to the location on your hard disk where you downloaded the program and double-click on it to bring up the connection screen. The AP Java Client connection screen is the same as the Windows version, except that it does not contain a menu bar with File and Help menus.

Note: When accessing the AP Java Client for the first time, you will be prompted to provide a serial number. This serial number can be found on the CD that came with your KVM.

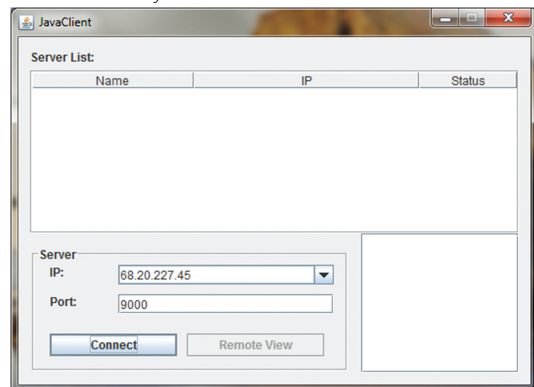

1. If your KVM is displayed in the Server List, connect to it by highlighting it and clicking on the *Connect* button.

Note: For a switch to show up in the Server List, the Enable Device List checkbox in the Operating Mode page (see Operating Mode section under Device Management in OSD Operation for details for details) must be checked and the Program server port must match what is set in the Network page (See Network section under Device Management in OSD Operation for details.)

2. If your KVM does not display in the *Server List*, enter in its IP address in the IP server field and click the *Connect* button.

3. Upon clicking the connect button, you will be prompted to enter your username and password. Enter in your username and password and press OK.

4. When connected, the *Remote View* button will be activated. Click on it to access the KVM remotely. Click on the *Disconnect* button to log out of the KVM switch.

OSD Operation

The OSD Main Page

After logging into the KVM switch, the OSD Main Page appears. Depending on how you logged into the switch, the interface will vary slightly. The following section describes the differences between these interfaces and the icons and functions you will find in them.

Web Browser Main Page

When logging into the KVM switch via web browser, the following page is displayed.

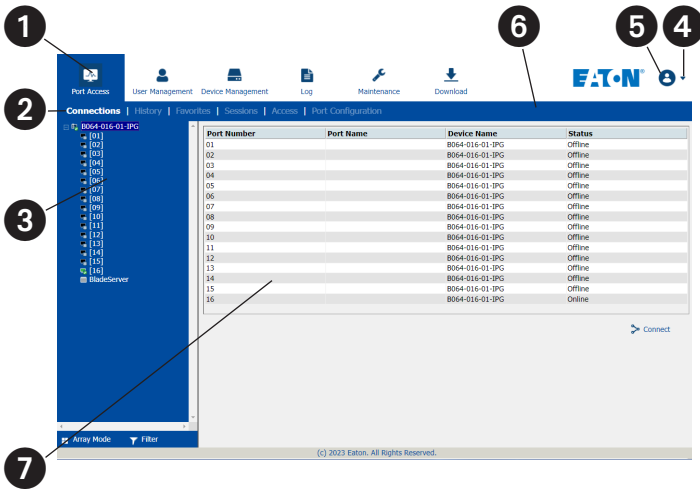

The following chart describes the components of this page.

No.	Component	Description
1	Tab Bar	The Tab Bar consists of category icons that take you to the various interfaces used to operate the KVM switch. The icons that are displayed in the Tab Bar depend on your user type (Super Administrator, Administrator, User), your permissions and the method you use to log into the KVM switch.
2	Menu Bar	The Menu Bar consists of sub-categories of the selected category icon. As with the Tab Bar, the sub-categories that show up in the Menu Bar depend on your user type and permissions.
3	Sidebar	The Sidebar displays a Tree Diagram that lists all of the functions available for the chosen category and sub-category. Clicking on one of the Sidebar functions will pull up the corresponding interface in the Interactive Display Panel. At the bottom of the Sidebar is a Filter button that allows you to display only the parts of the Tree Diagram that you filter for. (See <i>Filter</i> section under <i>Connections</i> in <i>OSD Operation</i> for details.)
4	About	Clicking on this icon pulls up the KVM switches firmware version
5	Logout	Clicking on this icon logs you out of the KVM switch
6	Welcome Message	When enabled (see <i>User Preferences</i> section under <i>OSD Operation</i> for details), this section of the main page will display a welcome message. This is disabled by default.
7	Interactive Display Panel	This is the main work area of the OSD. Different interfaces are displayed here depending on your category, sub-category and sidebar selections.

AP Client Main Page

When logging into the KVM switch via the non-browser AP Windows or Java client, the following page is displayed.

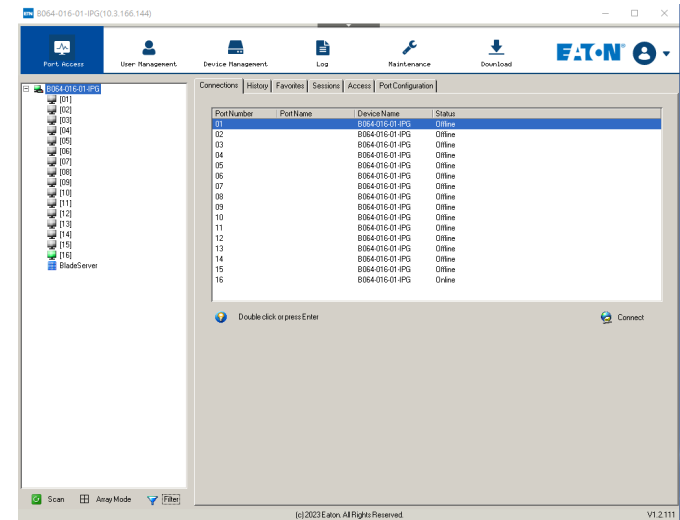

The AP Client Main Page differs from the Web Browser Main Page as follows:

- Instead of a Menu Bar, the AP Client Main Page has a set of notebook tabs that are used to select sub-categories. As with the Web Browser Main Page, the notebook tabs displayed depend on the user type and permissions.
- In addition to the Filter button at the bottom of the Sidebar, there is a Scan button and an Array Mode button.
- There is a hidden Control Panel (see *Control Panel* section under *Remote Session Operation* for details) at the upper center of the screen that becomes visible when you mouse over it.
- In addition to the two icons in the upper-right corner of the Web Browser Main Page, there is a third icon that closes the OSD and displays the screen of the last selected port.

The OSD can be navigated via keyboard using the commands in the table below:

Command	Description
Ctrl + P	Opens the Port Access category page
Ctrl + U	Opens the User Management category page
Ctrl + C	Opens the Device Management category page
Ctrl + L	Opens the Log category page
Ctrl + M	Opens the Maintenance category page
Ctrl + D	Opens the Download category page
F1	Displays the KVM switches firmware version
F2	Press to edit the name of the selected port
F4	Selects the Sidebar panel
F5	Selects the Interactive Display Panel
F7	Closes the OSD and displays the screen of the last selected port
F8	Logs you out of the KVM switch

OSD Operation







The OSD Main Page

Local Console Main Page



The Local Console Main Page is the same as the AP Client Main Page except that the Downloads icon in the tab bar is not available.

OSD Tab Bar

The number and type of icons that appear on the tab bar at the top of the page are determined by user type (Super Administrator, Administrator or User) and the permissions assigned when the account was created. The functions associated with each of the icons are explained in the following table:

Icon	Description
	Port Access: This page is used to access and control the devices on the KVM switch installation. This page is available to all users.
	User Management: This page is used to create and manage Users and Groups, and to assign devices to them. This page is available to Super Administrator and Administrators, ordinary users will not have access to it.
	Device Management: This page is used by the Super Administrator to configure and control the overall operation of the KVM switch. This page is available to Super Administrators or Administrators/Users who have been given access.
	Log: This page displays the contents of the log file. (See <i>Log</i> section under <i>OSD Operation</i> for details.)
	Maintenance: This page is used to install new versions of the B064-Series KVM Switch firmware. This page is available to Super Administrators or Administrators/Users who have been given access.
	Download: Users with appropriate permission can click this icon to download the AP Windows Client, the AP Java Client and the Log Server. This page is available to all users, although what downloads a User can access is determined by the Super Administrator or Administrator. <i>Note: The Download icon is not available via the local console.</i>

There are three small icons in the upper right-hand corner of the page. Their functions are described in the following table:

Icon	Description
	Click this icon to close the OSD page and return to the display of the last selected port. Note: <i>This icon is not available in the Web Browser Main Page.</i>
	Click this icon to display the firmware version of the B064-Series KVM Switch.
	Click this icon to log out and end your B064-Series KVM Switch session.

Port Access

The Port Access section of the OSD is where users can access KVM ports, and control settings that directly affect that access. The sub-sections contained in the Port Access section are described in the pages that follow.

OSD Operation

User Setting and Preferences

User Settings

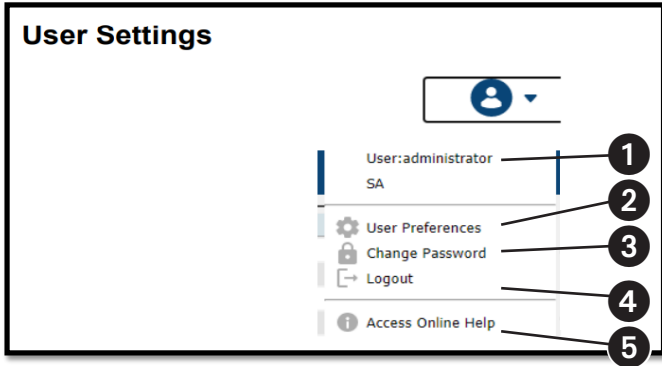

No.	Item	Description
1	User Information	Displays the user information and description.
2	User Preferences	Configures the user preference settings.
3	Change Password	Changes the login password.
4	Logout	Logs out and ends the session.
5	Access Online Help	Click to visit Eaton's website.

User Preferences

The User Preferences page allows users to set up their own individual working environments. The switch stores a separate configuration record for each user profile and sets up the working configuration according to the Username that was keyed into the Login dialog box:

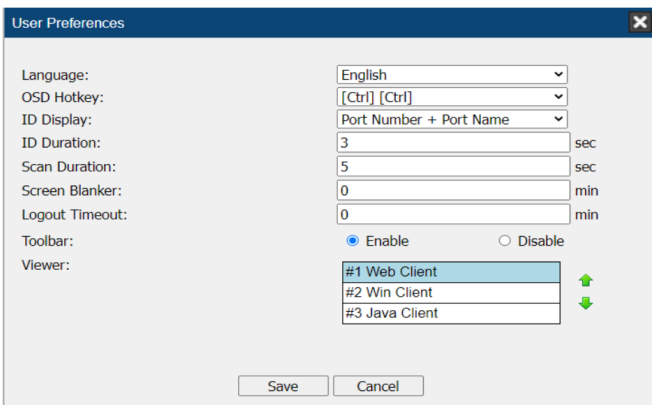

Setting	Function
Language	Selects the language that the interface displays in.
OSD Hotkey	"Selects which Hotkey controls the GUI function: [Scroll Lock] [Scroll Lock] is the default. To select a different combination, click the arrow at the right of the box to view a drop-down the list of choices."
ID Display	Selects how the Port ID is displayed: the Port Number alone (PORT NUMBER), the Port Name alone (PORT NAME) or the Port Number plus the Port Name (PORT NUMBER + PORT NAME). The default is PORT NUMBER + PORT NAME.
ID Duration	Determines how long a Port ID displays on the monitor after a port change has taken place. You can choose an amount from 1 - 255 seconds. The default is 3 Seconds. A setting of 0 (zero) indicates the Port ID is always on.
Scan Duration	Determines how long the focus dwells on each port as it cycles through the selected ports in Auto Scan Mode. Key in a value from 1 - 255 seconds. The default is 5 seconds and a setting of 0 disables the Scan function.

Setting	Function
Screen Blanker	If there is no input from the console for the amount of time set with this function, the screen will be blank. Key in a value from 1 - 30 minutes. A setting of 0 disables this function. The default is 0 (disabled). Note: Although this function can be set from either the local console or a remote login, it only affects the local console monitor.
Logout Timeout	If there is no user input for the amount of time set with this function, the user is automatically logged out. A login is necessary before the KVM over IP switch can be accessed again.
Toolbar	Selects whether or not the Port Toolbar is enabled when a port is accessed
Viewer*	In the browser version of this page, a Viewer section is available. You can choose which viewer method is preferred when connecting to a port by clicking the up or down arrow to shift viewer method position around. Usable viewers are automatically determined by the status of the system at the time of the login and by the type of browser. When you try to connect to a port (double-click the port or select a port and click the Connect), the system will use the viewer according to the viewer list.  <ul style="list-style-type: none"> The top-most method is the most preferred method and is listed as #1 (Web Client by default). If the preferred method is supported when connecting to a port, the system will try connecting using the preferred method. If the method is not supported, the system will try connecting using the next method, and try the last method last.
Save	"Click Save to save any changes made to the User Preferences settings."

Notes:

- *This item is only available with the browser version.
- The local console's User Preferences page additionally (and exclusively) provides the alarm setting for users to turn the device's alarm on (default) or off.

OSD Operation

Connections

The OSD Main page is the same screen that you get when navigating to the Connections sub-section of the Port Access section. From this page you can connect to the KVM ports.

All switches and their ports, including cascaded KVM switches, are listed in a tree structure in the panel at the left of the screen:

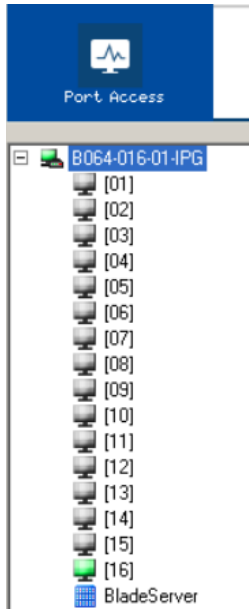

When accessing a port for the first time via web browser, users will experience a series of prompts:

Internet Explorer

When logging onto the KVM switch via Internet Explorer, the default viewer is the Windows ActiveX viewer. To use the Java Viewer when accessing the KVM switch via Internet Explorer, you need to update the *Viewer* setting in the *User Preferences* page (See *User Preferences* section under *OSD Operation* for details).

Note: Windows 7 users must run Internet Explorer as an administrator for the Active X control to work properly. If you don't run Internet Explorer as an administrator, you will not be able to access the connected computers.

1. When using the Windows ActiveX Viewer and clicking on a port for the first time, a screen will open up and you will be prompted to install the Windows ActiveX control. Click on the prompt and choose to install the ActiveX control.

Note: The screen that opens up may display a page that says the web pages certificate can not be trusted. If this is the case, click on the option to continue to the web page anyway.

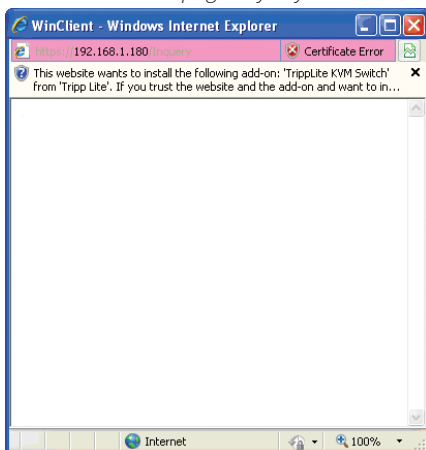

2. When you install the ActiveX control, you may be prompted to resend the information in order to display the web page.

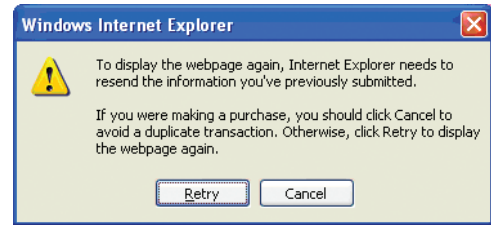

Click *Retry*.



3. Lastly, you will be prompted to install the software. Click *Install*.

Non-Windows Browser

When using a non-Windows browser, you will automatically be connected to remote computers using the Java Viewer.

1. When clicking on a port for the first time, you will be prompted to run the Java Viewer. Click *ok*. (To avoid this prompt every time you access a port, check the checkbox next to *Do this automatically for files like this from now on*.)

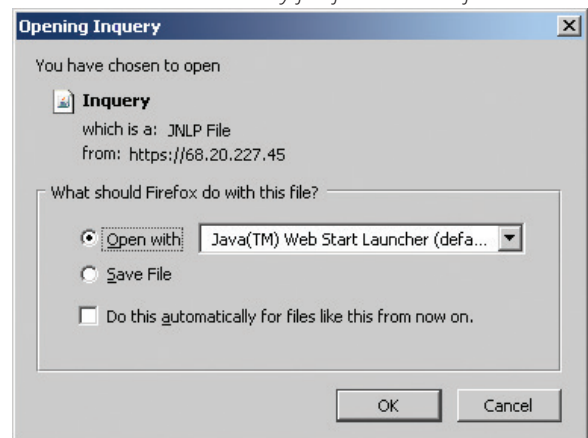

2. You will then be prompted to run the Java Viewer, and trust the publisher (Tripp Lite). Click *Run*.



Connections

The Port Selection List

- Users only see the switches and ports they have been given access to.
- Ports and cascaded KVM switches are located under their parent switches. Click the *Plus (+)* in front of a switch to expand the tree and see the ports underneath it.
Note: *In order for a cascaded B064-016 to show up as an expandable KVM in the port list, you must use a PS/2 SIU to cascade it from the first-level KVM. If you use a USB SIU, it will be displayed as an ordinary port, and you will have to use the B064-016 OSD to access computers/servers connected to it.*
- When expanded, there is a *Minus (-)* before the KVM's device name. Click the *Minus (-)* to collapse the tree and hide the ports.
- A port's ID number is displayed in brackets next to the port icon. For convenience, you can give each port a unique name in addition to this ID.
- KVM switches and ports that are on line have their monitor screen icons lit green. The monitor screens are gray for devices and ports that are offline.

Port Configuration

When accessing the KVM via AP Windows or Java Client, right-click on any port in the *Sidebar* to configure a connected computer or switch. (This feature is not available when accessing the OSD via web browser.) A list with options pops up. Listed items vary depending on user type and whether a cascaded KVM switch or a computer/server port was selected. Available configuration items are:

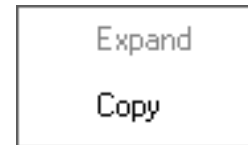

Item	Access Type	Description
Expand/ Collapse	Super Administrators, Administrators and Users	<ul style="list-style-type: none"> • If the device's ports are not displayed, the dialog box entry is <i>Expand</i>. Click <i>Expand</i> to open the tree and display the ports. • If the device's ports are displayed, the dialog box entry is <i>Collapse</i>. Click <i>Collapse</i> to close the tree view. <p>Note: <i>This item is only active for KVM switches that have child devices connected to them. This has the same effect as clicking the Plus (+) or Minus (-) in the tree view.</i></p>
Copy	Super Administrators, Administrators and Users	This item is only available for ports with computers/servers connected to them. It is used when creating a <i>Favorites</i> bookmark. (See <i>Adding a Favorite</i> section under <i>Favorites</i> in <i>OSD Operation</i> for details.)

Port Naming

For convenience, especially in large installations with many KVM switches and ports, each port can be given a unique name. To assign, modify or delete a port name, follow the instructions below.

Note: *Administrators and Users must be given configuration access to a KVM or computer port to be able to edit the port name. (See Device Assignment section under User Management in OSD Operation for details.)*

1. Click once on the port you want to edit to highlight it, wait one second and click on it again. *Note: This is not a double-click; it involves two separate clicks. Double-clicking will switch you to the device attached to the port.*

You can also right-click on the port you want to edit and select *Rename* in the popup box that appears (non-browser clients only).

After a second or two, the display changes to provide a text input box.

2. Key in a name for the port (or change/delete a previous one). The maximum number of characters allowed for a port name is 20. You can use any combination of letters, numbers, and symbols on the typewriter keys of keyboards with PC US English layout.
3. When you have finished editing the port name, press **[Enter]** or click anywhere outside of the input box to complete the operation.

OSD Operation

Connections

Port Properties

The port's settings can be changed via the Port Configuration page (see Port Configuration in **OSD Operation** for details).

Field	Description
Port OS	Specifies the operating system for the computer/server connected to the port. Choices are Windows, Mac, Sun, and Other. The default is Windows.
OS Language	Specifies the operating system language being used by the computer connected to the port. Click on the drop-down list to choose from a number of languages. The default is English US.
Cable Length	Specifies the length of the Cat5e cable that is being used to connect the computer to the port. Because the quality of video decreases when using longer cable, the B064-Series KVM Switch will make adjustments to improve the video quality based on this setting. Choices are Short (less than 32 ft.), Medium (32-82 ft.), and Long (greater than 82 ft.). The default is Short.
Access Mode	<p><i>Access Mode</i> defines how the port is to be accessed when multiple users are logged on. Choices are <i>Exclusive</i>, <i>Occupy</i>, and <i>Share</i>.</p> <p>Exclusive: The first user to switch to the port has exclusive control over the port. No other users can view the port. The Timeout function does not apply to ports which have this setting.</p> <p>Occupy: The first user to switch to the port has control over the port. However, additional users may view the port's video display. If the user who controls the port is inactive for longer than the time set in the Timeout box, port control is transferred to the next user to move the mouse or strike the keyboard.</p> <p>Share: Users simultaneously share control over the port. Input from the users is placed in a queue and executed chronologically. Under these circumstances, users can take advantage of the Message Board. The message board allows the user to manually take control of the keyboard and mouse only, or of the keyboard, mouse and video of a Share port. (See <i>Message Board</i> section under <i>Control Panel</i> in <i>Remote Session Operation</i> for details.)</p>
Occupy Timeout	<p>Please click the master KVM switch to access the Occupy Timeout setting.</p> <p>This field displays the timeout value that is set for all ports in the installation. When the port's Access Mode has been set to Occupy, if there is no activity from the user occupying the port for the amount of time set here, the user is timed out and the port is released. The first user to send keyboard or mouse input after the port has been released gets to occupy the port. As this setting is the same for all ports, you are not allowed to configure it on a port-by-port basis. This setting can be changed using the Port Properties dialog box for the master KVM switch, which is discussed in the Port Properties section.</p>

After making your configuration choices, click *Save* to save your new settings and close the dialog box.

Connections

Scan **Scan**

The *Scan* function automatically switches among all the ports accessible to the logged-on user at regular intervals, allowing their activity to be monitored automatically. (See *Auto Scanning* section under *Remote Session Operation* for details.) *Note: The Scan icon will not appear when accessing the KVM switch via web browser.*

Array Mode **Panel Array Mode**

Panel Array Mode also permits port activity to be monitored automatically. The screen displays a grid of panels, each representing a port on the installation. Only ports that are on line and user accessible are displayed. Off-line or non-accessible ports are left blank. (See *Panel Array Mode* section under *The OSD Toolbar* in *Remote Session Operation* for details.)

Filter **Filter**

Filter allows you to control which ports are displayed in the *Port Selection List*, as well as which ports are scanned when *Auto Scan Mode* is invoked. When you click *Filter*, the bottom of the panel changes to look similar to the figure, below:

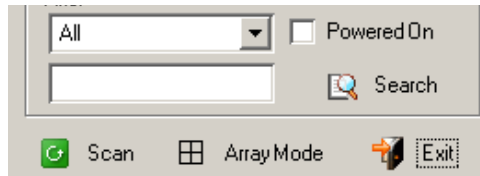

All – with no other filter options selected, lists all of the ports on the installation.

- Putting a check mark in the *Powered On* checkbox lists only the ports that have their attached devices powered on.
- The text input box and *Search* button allow you to key in a search string so that only port names that match what you key in show up in the list.

Interactive Display Panel

The *Connections* sub-section will display port status information on the *Device Level* and port connection and configuration options at the *Port Level*.

Device Level

When a KVM switch is selected in the *Sidebar* tree, the *Connections* sub-section will display a list of the ports that are accessible to the logged-on user.

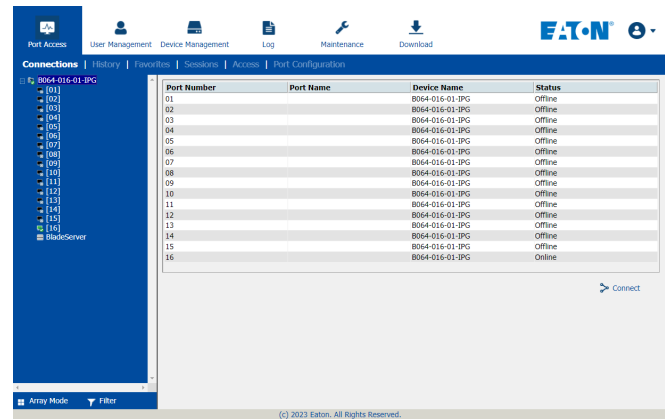

OSD Operation

Connections

The chart below describes the attributes that are listed for each port.

Attribute	Description
Port Number	The KVM switch port that the computer or KVM is connected to
Port Name	If a port is assigned a name, it is displayed here
Device Name	The name of the KVM switch that the port is on
Status	Current status of the computer or KVM connected to the port; Online or Offline
Connect	A <i>Connect</i> icon will be located underneath the port list. Highlight a port and click <i>Connect</i> to open up a remote session with the selected port displayed.

Note: When accessing the KVM via web browser, this page can be sorted by any attribute by clicking on the column header.

Port Level

When a port is selected in the *Sidebar* tree, the *Connections* sub-section will display port connection and configuration options.

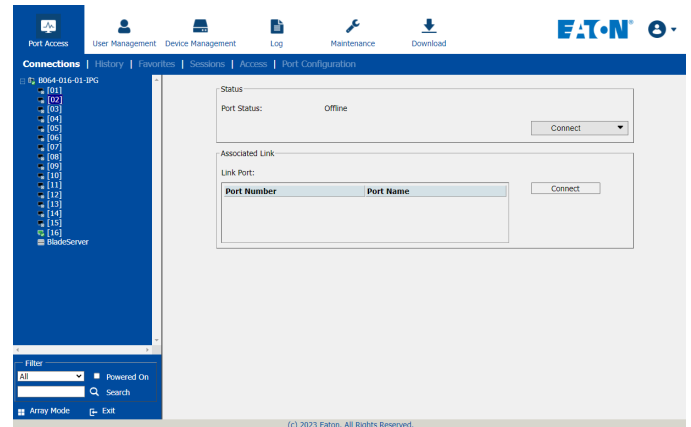

The chart below describes the sections that are displayed on this page.

Section	Description
Status	This displays the <i>Port Status</i> ; whether it is online or offline, and whether virtual media can be mounted to it. Click on the <i>Connect</i> button to open a remote session with the selected port displayed.
Associated Link	Each port can have additional ports associated with it, so that the user can access multiple ports via one connection page. <i>Associated Links</i> can be added/removed from the <i>Port Configuration</i> sub-section (see <i>Port Configuration</i> section under <i>OSD Operation</i> for details). When ports are available in the <i>Associated Link</i> section, simply highlight one and click the <i>Connect</i> button to open a remote session with that port displayed.

History

The *History* page provides a record of each time that a port was accessed.

- If there are more entries than there is room on the screen, a scroll bar appears to let you scroll up and down to see the entire record.
- To clear the records and start over, click the *Clear History* button at the bottom right corner of the page.

Note: You can access a port in the *History* page by double clicking it, or highlighting it and pressing **[Enter]**. When accessing the KVM switch via web browser, you can sort the results by clicking on any of the column headers.

Favorites

Favorites is similar to a bookmarks feature. Frequently visited ports can be listed on this page. Open this page and select the port instead of searching for it in the tree view. This feature is especially useful for larger, cascaded installations. *Note: Each Favorites bookmark that you create is a folder in which multiple ports can be saved.*

Adding a Favorite

To add a port to *Favorites*, do the following:

1. Right click in the main panel and click on the *Add Favorite* option that appears. An entry appears named *Untitled Favorite*.

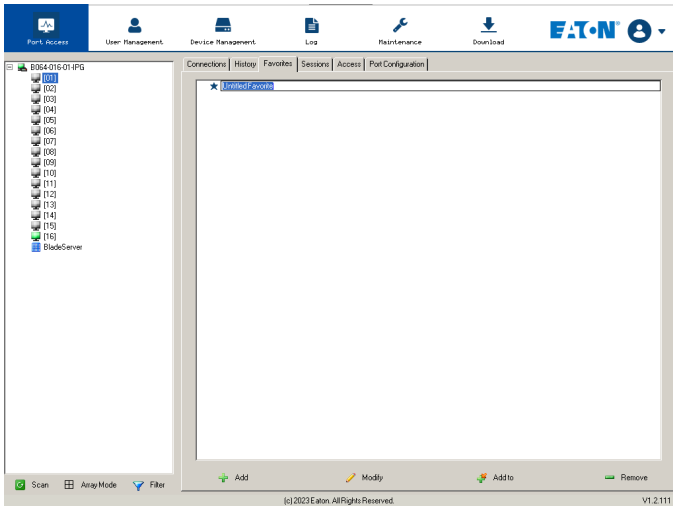

2. Click inside the text entry box to erase *Untitled Favorite* and key in the desired name.
3. To add a port, drag it from the *Port Select* list and drop it into the *Favorites* bookmark you just created. You can also add a port by right-clicking on it and selecting *Copy*. After copying, right-click on the *Favorites* bookmark and select *Paste*. The KVM switch the port is connected to goes into the *Favorites* bookmark along with the port. The port is located under the switch, as it would be in the tree view on the left-hand panel.

Note: Right-clicking on a port that is already in a *Favorites* bookmark will give you the option to cut the port out of that bookmark and paste it into another *Favorites* bookmark.

4. Repeat step 3 for any other ports you want to add to your *Favorites* bookmark.

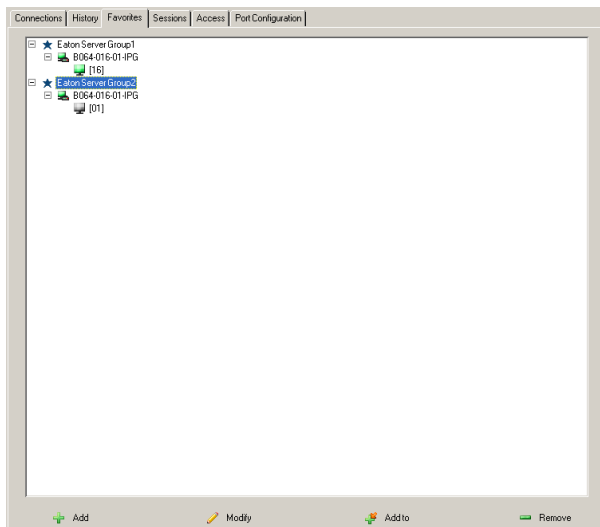

Modifying a Favorite

To modify a *Favorites* bookmark, right-click on it and select one of the options from the pop-up menu that appears. The menu that appears allows you to perform the following options:

Collapse/Expand – As with the tree view on the right-hand side of the page, this option allows you to either collapse or expand the *Favorites* bookmark and all of its included ports

Add Favorite – Select this option to create a new *Favorites* bookmark

Delete – Select this option to delete the selected *Favorites* bookmark

Rename – Select this option to change the name of the *Favorite* bookmark

Copy – Select this option to copy all of the *Favorites* bookmark's contents, in order to paste them into another *Favorites* bookmark

Paste – Select this option to paste copied ports into the selected *Favorites* bookmark

Note: Right-clicking on a port that is already in a *Favorites* bookmark will give you the option to Cut the port out of that bookmark and paste it into another *Favorites* bookmark.

OSD Operation

Sessions

The *Sessions* sub-section allows Super Administrators and Administrators to see who is logged into the KVM switch, and provides information about each of their sessions. Super Administrators can see all accounts that are logged into the KVM, whereas Administrators are only able to see Administrator and User accounts.

It also provides the option of ending a session by selecting the account from the *Sessions* list and clicking the *End Session* icon. To refresh the *Sessions* list to display the most current information, click on the *Refresh* icon.

Note: The *Sessions* tab is only available for Super Administrators and Administrators. Users will not be able to access it.

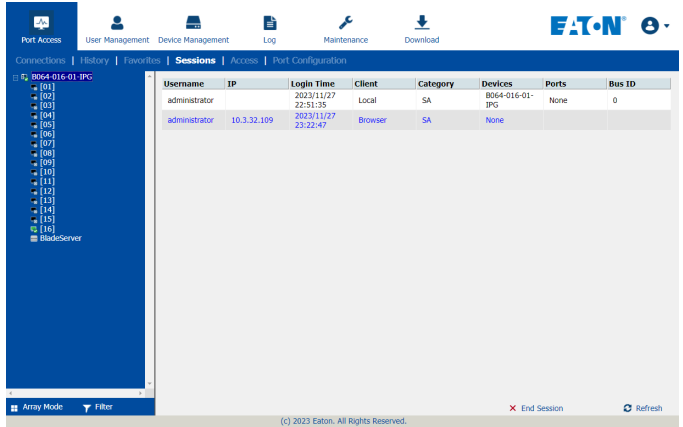

Access

The *Access* sub-section allows Super Administrators and Administrators to set user/group access and configuration rights for switches and ports. As with the *Sessions* sub-section, Super Administrators can see all accounts, whereas Administrators can only see Administrator, User and Group accounts. The browser and non-browser *Access* sub-sections are the same, except the non-browser page includes drop-down filters above each column. These filters allow you to choose which accounts are displayed. For example, you can choose to display only those accounts that are given configuration access to the selected KVM/port by choosing the *Permitted* option from the drop-down menu above the configuration column.

Note: The *Access* sub-section is not available to User accounts, and will not show up when they log into the OSD. The *Access* sub-section does not appear when a *Blade Server* is selected in the *Sidebar* tree.

When the master KVM switch is highlighted in the port list, the *Access* sub-section displays only one setting column; Config. When a port is highlighted in the port list, the *Access* sub-section displays three settings columns; Access, Mount USB and Config. The section that follows describes these settings, and how to edit them.

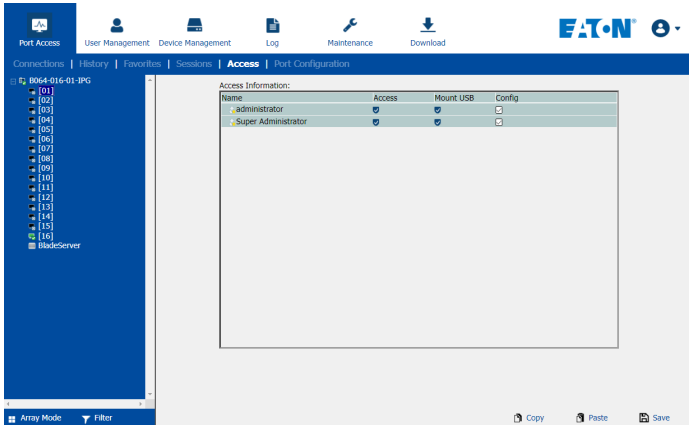

OSD Operation

Access

Setting	Description
Access	The <i>Access</i> setting determines if an account is allowed to access the selected port, and if so, what level of access the account has. To edit this setting, click on the box in the <i>Access</i> column next to the account you wish to edit. Continue to click until you toggle to the desired setting. Full Access - This setting is represented by an icon that shows a pair of glasses and a pencil. It allows the corresponding account to both view video and perform operations on the selected port. View Only - This setting is represented by a pair of glasses only. It allows the corresponding account only to view video of the selected port. No Access - This setting is represented by an X, and denies the corresponding account access to the selected port.
Mount USB	The <i>Mount USB</i> setting determines if an account is allowed to access the virtual media functionality on the selected port, and if so, what level of access the account has. To edit this setting, click on the box in the <i>Mount USB</i> column next to the account you wish to edit. Continue to click until you toggle to the desired setting. Full Access - This setting is represented by an icon that shows a pair of glasses and a pencil. It allows the corresponding account to both read and write to virtual media mounted to the selected port. View Only - This setting is represented by a pair of glasses only. It allows the corresponding account only to read virtual media mounted to the selected port. No Access - This setting is represented by an X, and denies the corresponding account access to virtual media mounted to the selected port.
Config	The <i>Config</i> setting determines if an account has permission to make changes to the master KVM or port configuration settings. To edit this setting, click on the box in the <i>Config</i> column next to the account you wish to edit. Click to toggle <i>Config</i> access on/off. A check mark enables access, an X disables access. Note: <i>Config</i> checkboxes are provided as a way for Super Administrators and Administrators to customize which ports Administrators and User accounts have Configuration access to. In order for the <i>Config</i> checkbox to enable Configuration access to a port, the Administrator or User account must be given Port Configuration access to the KVM switch. (See Permissions in the Adding User Accounts section under User Management in OSD Operation for details.)

When you are done editing access rights to the selected port, click on the *Save* icon in the lower-right corner of the *Access* sub-section.

Also at the bottom of the page are *Copy* and *Paste* icons. These are used to copy the access settings from one port and paste those same settings to another port. To do this, simply highlight the port you want to copy and click on the *Copy* icon. Then highlight the port you want to paste to and click the *Paste* icon.

Port Configuration

The *Port Configuration* sub-section allows Super Administrators and Administrators to edit port properties settings, assign system macros to a port, and add/remove associated links. When the master KVM is highlighted and the *Port Configuration* sub-section is selected, the following screen appears.

The only setting that appears on this page is the *Occupy Timeout* setting. This setting controls the amount of inactivity time before a port that is set to *Occupy* (see *Port Property* section on the following page for details) is opened for access by another user. Enter in a value from 0 to 255 seconds. The default is 3 seconds.

When a standard port is highlighted and the *Port Configuration* sub-section is selected, a screen opens up that contains two sections; *Port Property* and *Associated Link*. The *Port Property* section is opened first by default.

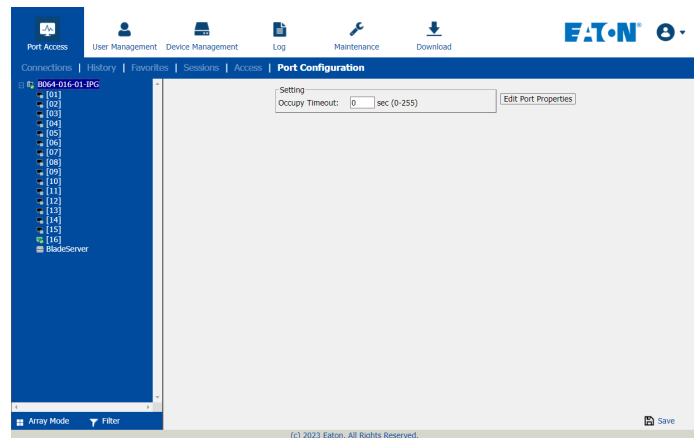

OSD Operation

Port Configuration

Port Property

The *Port Property* page of this subsection lists status information about the selected port, and provides editable settings related to the connected computer and system macros. The contents of this page are described in the table below.

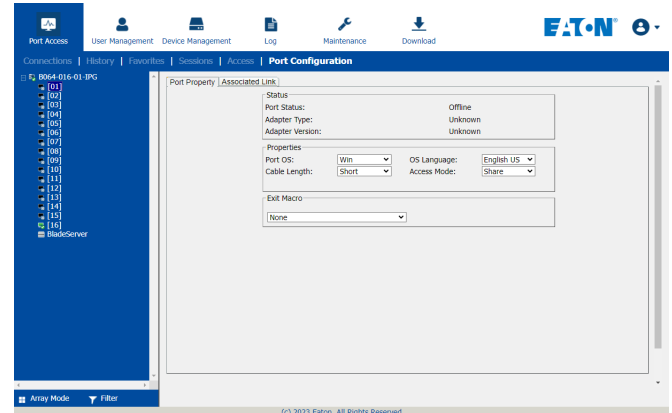

Setting	Description
Status	<p>Port Status – The status of the selected port is displayed here. If no computer/KVM is connected, or a computer/KVM is connected but not powered on, the port status will show up as <i>Offline</i>. If a computer is connected via B055-001-USB-V2 and powered on, the port status will show up as <i>Online Mountable</i>. If a computer is connected via any other SIU and powered on, the port status will show up as <i>Online</i>.</p> <p>Adapter Type – The model number of the SIU on the selected port will be displayed here.</p> <p>Adapter Version – The firmware version of the SIU on the selected port will be displayed here.</p>
Properties	<p>Port OS – Selects the OS of the computer connected to the port. The options are <i>Windows, Mac, Sun</i> and <i>Other</i>.</p> <p>OS Language – Selects the language being used on the computer connected to the port.</p> <p>Access Mode – Selects how the port is to be accessed when multiple users are logged onto the same port at the same time. Choices are <i>Exclusive, Occupy</i> and <i>Share</i>.</p> <ul style="list-style-type: none"> • <i>Exclusive</i> – The first user to access the port has exclusive control over it, and no other users can access the port. The <i>Occupy Timeout</i> function does not apply to ports that are set to <i>Exclusive</i>. • <i>Occupy</i> – As with <i>Exclusive</i>, the first user to access the port has control over it; however, users that log on at the same time can view the ports video. If the user who controls the port is inactive for longer than the time set in the <i>Occupy Timeout</i> function, port control is transferred to the next user to access it. • <i>Share</i> – In this mode, users simultaneously share control over the port. Input from the users is placed in a queue and executed chronologically. Under these circumstances, users can take advantage of the <i>Message Board</i> feature on the <i>Control Panel</i> (see <i>Message Board</i> section under <i>Control Panel</i> in <i>Remote Session Operation</i> for details). <p>B064-008-01-IPG & B064-016-01-IPG Only:</p> <p>Cable Length – Lets you specify how long the Cat5e/6 cable between the port and the KVM adapter cable is. Use the drop-down menu to select the cable length settings: Short: Up to 25 m (82 ft.) Medium: 20 m to 35 m (65 ft. to 115 ft.) Long: Above 35 m (115 ft.)</p>
Exit Macro	<p>This section is available only when the highlighted port is connected to a computer. If the highlighted port is connected to a KVM, this setting will not be available. Click on the drop-down menu to open up a list of the <i>System Macros</i> (see <i>System Macros</i> section under <i>Control Panel</i> in <i>Remote Session Operation</i> for details) that are available for use. Choose a macro from this list to have it performed on the selected port upon logging out.</p>

When you are done editing, click the *Save* icon to save the changes.

Associated Link

This page allows you to associate links to other ports in the installation with the highlighted port. When an associated link is made, it is displayed in the *Associated Link* table of the port's *Connections* screen (see *Connections* section under *OSD Operation* for details). To add an associated link, click the *Add* button, enter the desired port number in the box that appears, and click the *OK* button. It will then appear in the list of associated links. To remove a link, simply highlight it and click the *Remove* button.

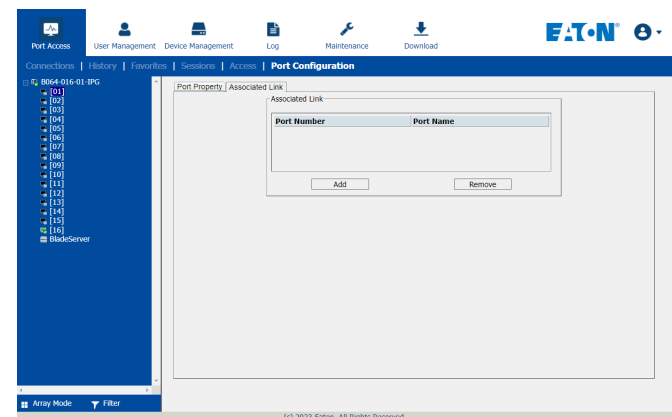

Blade Configuration

Blade Servers that are connected to the switches display below the KVM switches in the Sidebar. This section describes accessing and configuring the blade servers, and associating the blades with KVM switch ports. By associating a blade server or blade with a port, the servers and blades are integrated into the Sidebar tree view and appear as devices connected to the port.

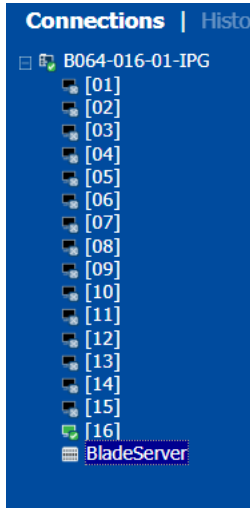

The Blade Configuration page is where the associations between blade servers and ports on the KVM switch get created. To access this page, select the blade server or blade, then click the *Blade Configuration* sub-section tab.

For IBM and Dell blade servers, the entire chassis gets associated with a port, and each blade in the chassis will appear in the tree as a child port of the associated port—as shown by the screenshot of port 08 below.

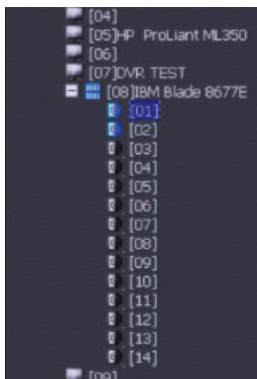

For HP blade servers, associations are made on a blade by blade basis. Each blade is associated with a single port. To access a blade, click on its port entry in the tree.

Associating Ports

Device View

Port association begins by clicking the *Blade Configuration* sub-section tab in the menu bar. The page comes up in Device View, listing all of the KVM switch's ports, and the blade servers (IBM and Dell servers), or individual blades (HP servers) that have been associated with them.

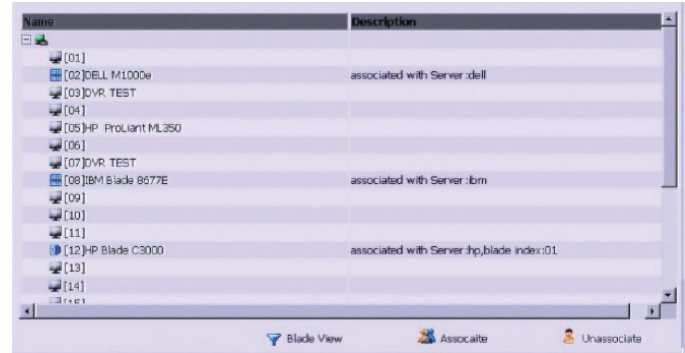

To associate a blade server or blade with a port, follow the steps below.

1. Select the port in the main panel.
2. Click *Associate*.
3. In the screen that comes up, select the blade server or individual blade that you want to associate with the selected port.

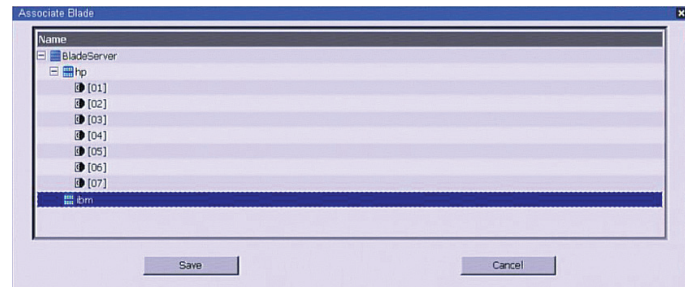

4. Click *Save*.

After the association completes successfully, the blade icon appears next to the associated port in the Sidebar tree. To access the device running on the blade, click on its entry in the Sidebar tree.

OSD Operation

Blade Configuration

Blade View

At the bottom of the main panel is a button labeled *Blade View*, which toggles between *Device view* and *Blade view*. Click on it to bring up the *Blade View*.

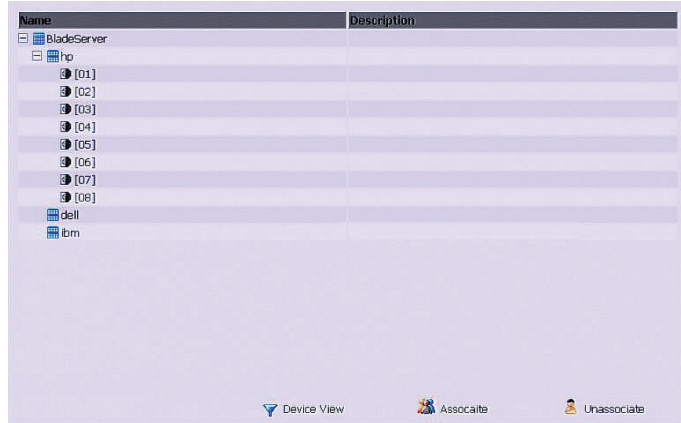

Blade View lists all of the blade servers (IBM and Dell servers) and individual blades (HP servers) that are installed on the system, and the ports (if any) that they are associated with. To make an association from the blade view, you first select a blade server or blade, then select a KVM port to associate it with as follows.

1. Select the blade server or blade in the main panel.
2. Click *Associate*.
3. In the screen that appears, select the port that you want to associate it with.
4. Click *Save*.

After the association completes successfully, the blade icon appears next to the associated port in the Sidebar tree. To access the device running on the blade, click on its entry in the Sidebar tree.

Disassociating Ports

To break the association between a port and a blade or blade server, simply select the association in the main panel, and then click *Unassociate*.

User Management

The *User Management* section allows Super Administrators, and Administrators and Users who have been given *User Management* permission, to add/edit accounts on the KVM switch. If an account has not been given *User Management* permission, the *User Management* icon will not show up in the OSD when they log in. The *User Management* section is displayed differently when accessing the OSD via web browser or one of the non-browser clients. The web browser version contains two sub-sections, one for *Accounts* and one for *Groups*. The non-browser version contains one section, in which both User accounts and *Group* accounts are displayed in the list on the left side of the screen. The non-browser version also includes filtering options below the User/Group list.

Note: Administrators with *User Management* permission can only add/edit Administrator and User accounts. Users with *User Management* permission can only add/edit User accounts. Super Administrators can add/edit all account types.

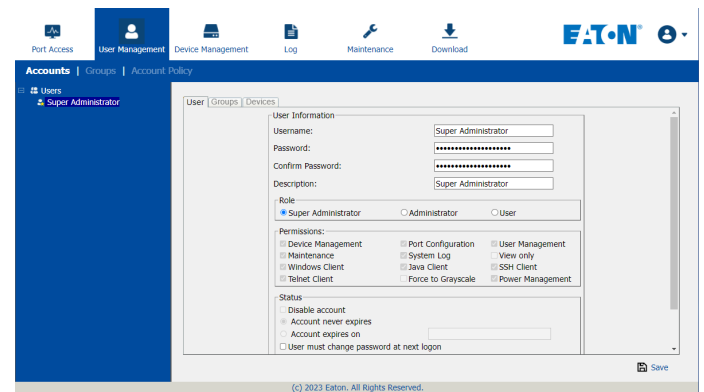

Adding User Accounts

There is a default Super Administrator account on the KVM switch that can be used to set up the KVM switch. The default Super Administrator username is *administrator*, and the default password is *password*. It is strongly recommended that you update this default accounts username and password to something unique. To add a new user account, do the following:

1. Highlight *Users* from the list on the left side of the page, and then click the *Add* button at the bottom of the screen. The user information page opens.
2. Enter in the appropriate information for the account you are creating, and click the *Save* button when you are done. The contents of the user information screen and their meanings are described in the table below.
3. Upon clicking *Save*, a prompt appears to inform you that the operation succeeded. Click the OK button to exit.

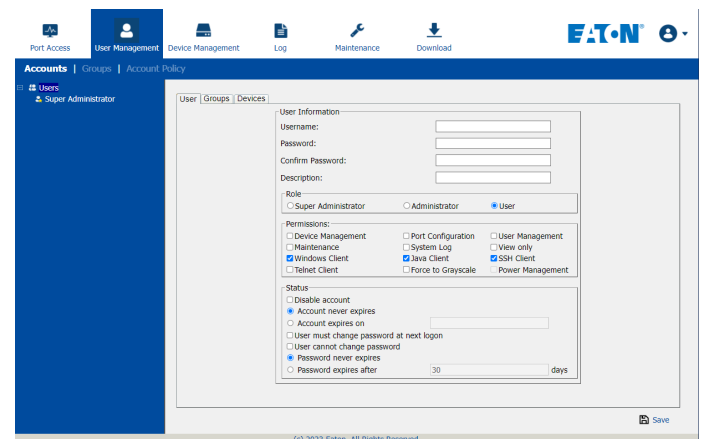

User Management

Adding User Accounts (continued)

Field	Description
Username	Enter a username for the account here. The username can contain up to 16 characters, and must meet the <i>Account Policy</i> requirements set in the <i>Security</i> sub-section. (See <i>Security</i> section under <i>Device Management</i> for details.)
Password	Enter a password for the account here. The password can contain up to 16 characters, and must meet the <i>Account Policy</i> requirements set in the <i>Security</i> sub-section. (See <i>Security</i> section under <i>Device Management</i> for details.)
Confirm Password	For security purposes you must re-enter the password. If the password does not match the password you just entered in the previous field, you will not be allowed to save the account information.
Description	Enter any additional information that you want to describe the account. This is an optional field.
Role	<p>Select the type of account that you will be creating; <i>Super Administrator</i>, <i>Administrator</i> or <i>User</i>. There is no limitation on the number of each type of account that can be created, only a limit on the number of total accounts. You can create up to 64 accounts on the KVM switch.</p> <ul style="list-style-type: none"> • <i>Super Administrator</i> – This account type has full access to all aspects of the KVM switch. They can fully access all computers/devices connected to the KVM, change any and all settings, and add/edit any account type. • <i>Administrator</i> – This account type defaults at full access to the KVM switch, the same as a <i>Super Administrator</i>; however, which ports the account has Configuration access to is determined by a <i>Super Administrator</i> or <i>Administrator</i> that creates/edits the account.. Also, <i>Administrators</i> with <i>User Management</i> permission are limited to adding/editing <i>Administrator</i> and <i>User</i> accounts. • <i>User</i> – This account type defaults at no access to the KVM switch, and is only given the initial permissions of <i>Windows Client</i>, <i>Java Client</i> and <i>SSH Client</i>. <i>Super Administrators</i> and <i>Administrators</i> can customize a <i>User</i> profile however they like. If a <i>User</i> is given <i>User Management</i> permission, they are only allowed to add/edit other <i>User</i> accounts.
Permissions Note: <i>Power Management</i> is not a selectable field and has no functionality, regardless of whether or not the box is checked.	<p>The permission settings in this section of the user information page determine what functionality the account is able to use. Check the checkbox next to the permission to enable it for the account. Leave it unchecked to deny the account access to that functionality.</p> <ul style="list-style-type: none"> • <i>Device Management</i> – Gives an account to access to the KVM settings found in the <i>Device Management</i> section, such as network and advanced network management (ANMS) settings. (See <i>Device Management</i> section under <i>OSD Operation</i> for details.) If this checkbox is not checked, the <i>Device Management</i> icon will not appear when the account logs into the OSD. • <i>Port Configuration</i> – Allows an account to edit the <i>Port Configuration</i> settings for individual KVM ports. (See <i>Port Configuration</i> section for details.) <i>Note: The Port Configuration setting simply allows for an account to be given Configuration access to the connected ports. Configuration permission for each port must still be given via the Access sub-section of the Port Access section, or via the Devices tab in the Adding/Editing Users section.</i> • <i>User Management</i> – Allows an account to add/edit other accounts. <i>Administrators</i> can add/edit <i>Administrator</i> and <i>User</i> accounts. <i>Users</i> can add/edit other <i>User</i> accounts. <i>Super Administrators</i> can add/edit all account types. If this checkbox is not checked, the <i>User Management</i> icon will not appear when the account logs into the OSD. • <i>Maintenance</i> – Gives the account access to the settings and functionality found in the <i>Maintenance</i> section, which includes upgrading the KVM and SIU firmware, and backing up and restoring the KVM settings, in addition to other features. (See <i>Maintenance</i> section for details.) If this checkbox is not checked, the <i>Maintenance</i> icon will not appear when the account logs into the OSD. • <i>System Log</i> – Gives the account access to the <i>Log</i> section of the OSD, where they can view events that have taken place on the installation and customize notification settings. (See <i>Log</i> section for details.) If this checkbox is not checked, the <i>Log</i> icon will not appear when the account logs into the OSD. • <i>View Only</i> – Limits the account to viewing the video of connected computers only. They will not be able to perform keyboard and mouse functions. • <i>Windows Client</i> – Gives the account access to the browser and non-browser versions of the Windows client. • <i>Java Client</i> – Gives the account access to the browser and non-browser versions of the Java client. • <i>SSH Client</i> – Allows the account access to the KVM switch via a SSH client. • <i>Telnet Client</i> – Allows the account to access the KVM switch via a Telnet Client. • <i>Force to Grayscale</i> – Forces the account to view remote video in black and white.
Status	<p>This section determines how long an account or password has until it expires or needs to be changed.</p> <ul style="list-style-type: none"> • <i>Disable Account</i> – Disables an account, preventing it from accessing the KVM switch. This gives you an alternative to deleting the account, in which you can disable the account, and then reinstate it in the future without having to re-enter the account settings. • <i>Account Never Expires</i> – If this option is checked, the account will stay active forever, or until deactivated manually. • <i>Account Expires On</i> – To set a date for the account to be disabled on, check this checkbox and enter in a date in the corresponding field. • <i>User Must Change Password at Next Logon</i> – To force the account to change their password the next time they logon, check this checkbox. The next time the account logs on, they will be prompted to enter in a new password. • <i>User Cannot Change Password</i> – Check this checkbox to prevent the user from changing their password on their own. • <i>Password Never Expires</i> – If this option is checked, the account's password will stay active forever, or until manually forced to be changed. • <i>Password Expires After</i> – To force an account to change their password after a certain number of days, check this checkbox and enter in the number of days until the password expires.

OSD Operation

User Management

At this point you can do any of the following:

- Assign the new user to a group by selecting the *Groups* tab in the user's notebook. (See *Assigning Users to a Group from the User's Notebook* section under *User Management* for details.)
- Assign port access rights for a user by selecting the *Devices* tab. (See *Device Assignment* section under *User Management* in *OSD Operation* for details.)
- Add more users and/or create groups and finish configuring the user account later.

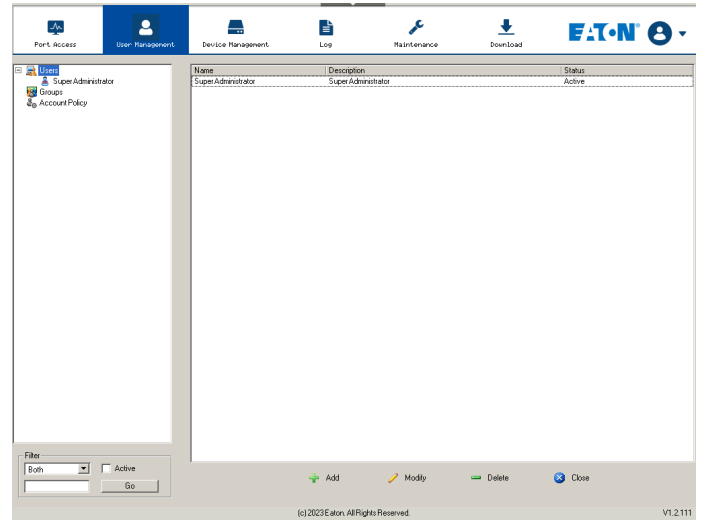

Modifying User Accounts

To modify a user account, do the following:

1. Select the desired user's name from the User List or the Main Panel and click *Modify*.
2. The same as when creating an account, make any necessary changes to the user account and click *Save*.

Deleting User Accounts

To delete a user account, do the following:

1. Select the desired user's name from the Main Panel and click *Delete*.
2. A confirmation dialog box will appear asking if you are sure you want to delete the selected user account. Click *OK*.

Groups

Groups give *Administrators* and *Super Administrators* a convenient way to efficiently manage users and devices. Since device access rights apply to anyone who is a member of the group, administrators need only set them once for the group, instead of having to set them for each user individually. Multiple groups can be defined to allow some users access to specific devices, while restricting other users from accessing them.

Groups – Creating Groups

To create a group, do the following:

1. Highlight *Groups* in the Groups List on the left side of the screen.
Note: When accessing the OSD via web browser, you will need to click the *Groups* sub-section tab first.
2. Click *Add* at the bottom of the main panel. The Group notebook opens, with the *Group* tab selected:

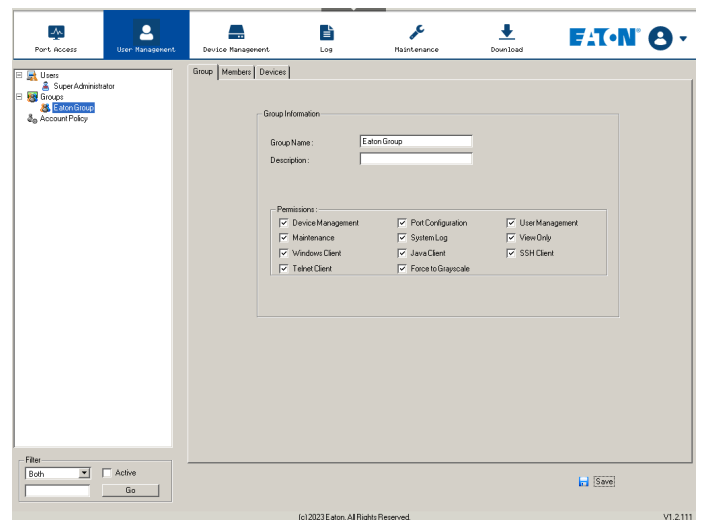

User Management

3. The group information screen that appears is similar to the user information screen, except that the *Status* section is not displayed. Edit the group information the same as with a user account.

4. When your selections have been made click *Save*.

5. When the Operation Succeeded popup appears, click *OK*.

6. Click *Group* in the List panel to return to the main screen. The new group appears in the list and in the main panel, as well.

At this point you can do any of the following:

- Assign users to the group by selecting the *Members* tab in the group's notebook. (See *Assigning Users to a Group from the Group's Notebook* section under *User Management* for details.)
- Assign port access rights for a group by selecting the *Devices* tab. (See *Device Assignment* section for details.)
- Add more groups and/or users and finish configuring the group account later.

Groups – Modifying Groups

To modify a group, do the following:

1. Click the group's name in the Group list or select the group's name in the Main Panel and click *Modify*.
2. Make any necessary changes to the group account and click *Save*.

Groups – Deleting Groups

To delete a group do the following:

1. Select the group's name in the main panel and click *Delete*.
2. A confirmation dialog box will appear asking if you are sure you want to delete the selected group account. Click *OK*.

Assigning Users to Groups

There are two ways to assign users to a group and remove them from a group; via the User's notebook or Group's notebook.

Assigning Users to a Group via the User's Notebook

To assign a user to a group from the User's notebook, do the following:

1. Select the user's name from the User List or select the user's name from the Main Panel and click *Modify*.

Note: Super Administrators *can not be assigned to a group, as they already have access to the entire installation.*

2. When the user's notebook appears, select the *Groups* tab. A screen similar to the one below appears:

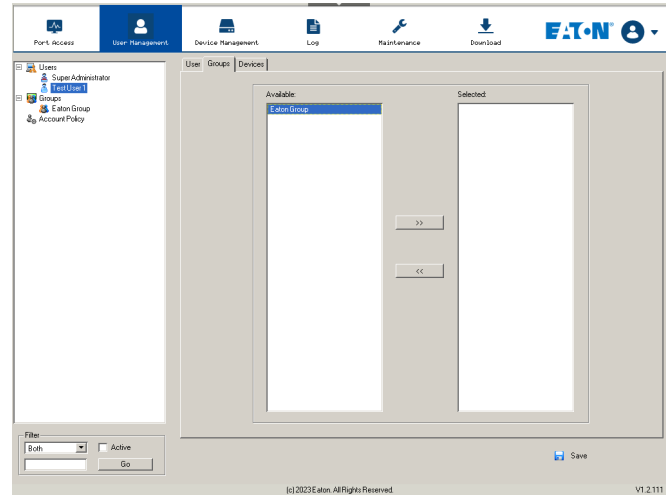

3. In the *Available* column, select the group that you want the user to be in.

4. Click the Right Arrow to put the group's name into the *Selected* column and click *Save*.

Removing Users From a Group via the User's Notebook

To remove a user from a group from the User's notebook, do the following:

1. Select the user's name from the User List or select the user's name from the Main Panel and click *Modify*.
2. When the user's notebook appears, select the *Groups* tab. A screen similar to the one below appears:

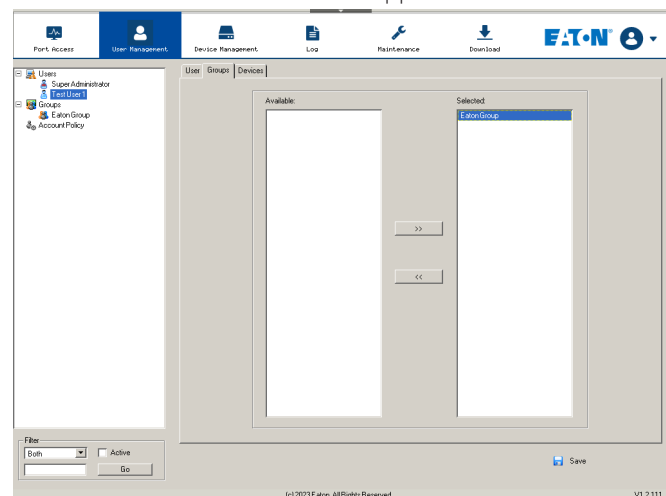

3. In the *Selected* column, select the group that you want to remove the user from.

4. Click the Left Arrow to remove the group's name from the *Selected* column and put it back into the *Available* column. Click *Save*.

OSD Operation

User Management

Assigning Users to a Group via the Group's Notebook

To assign a user to a group from the Group notebook, do the following:

1. Select the group's name in the Group list or select the group's name in the Main Panel and click *Modify*.
2. When the group's notebook appears, select the Members tab. A screen similar to the one below appears:

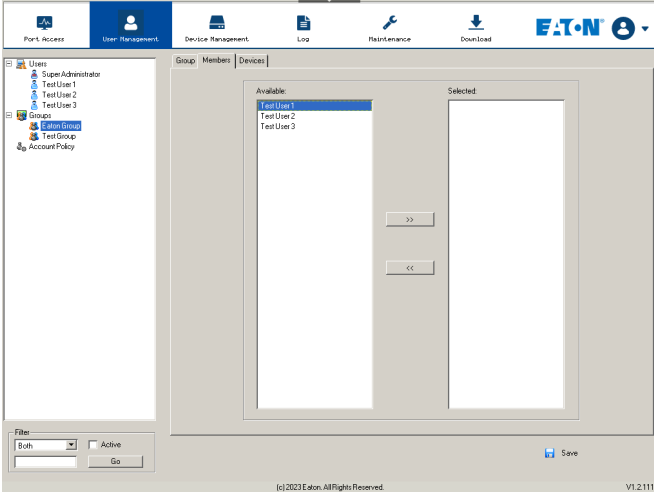

3. In the *Available* column, select the user that you want to add to the group.

Note: Super Administrators will not show up in the Available list, as they already have access to the entire installation and cannot be added to a group.

4. Click the Right Arrow to put the user's name into the *Selected* column.
5. Repeat the above for any other users that you want to add to the group.
6. Click *Save* when you are done.

Account Policy

Account Policy

Minimum Username Length:

Minimum Password Length:

Password Must Contain At Least

One Upper Case

One Lower Case

One Number

One Special (e.g., ~ ! @ # \$ % ^ & * () _ + = - ' [] / ? > <)

Minimum number(%) of characters changed from previous password:

Disable Duplicate Login

Enforce Password History

Removing Users From a Group via the Group's Notebook

To remove a user from a group via the Group's notebook, do the following:

1. Select the group's name in the Group list or select the group's name in the Main Panel and click *Modify*.
2. When the group's notebook appears, select the Members tab. A screen similar to the one below appears:

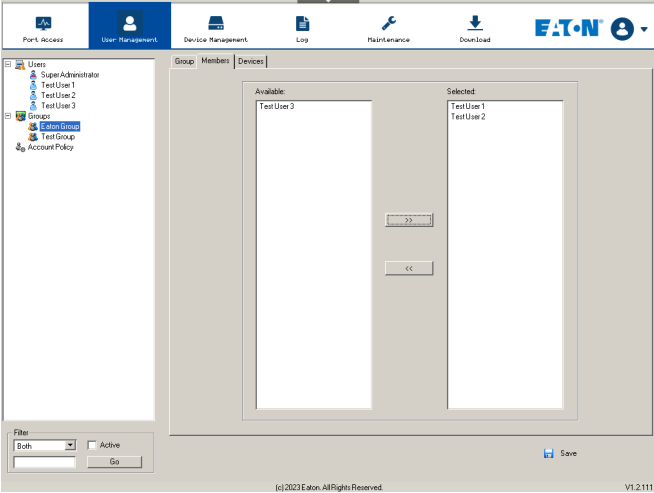

3. In the *Selected* column, select the user that you want to remove from the group.
4. Click the Left Arrow to remove the user's name from the *Selected* column and send it back to the *Available* column.
5. Repeat the above for any other users that you want to remove from the group.
6. Click *Save* when finished.

Entry	Explanation
Minimum Username Length	Sets the minimum number of characters required for a username. Acceptable values are from 1–16. The default is 6.
Minimum Password Length	Sets the minimum number of characters required for a password. Acceptable values are from 0–32. A setting of 0 indicates no password is required. Users can login with only a Username. The default is 6.

User Management

Entry	Explanation
Password Must Contain At Least	Checking any of these items requires users to include at least one uppercase letter, one lowercase letter or one number in their password. Note: This policy only affects user accounts created after this policy has been enabled, and password changes to existing user accounts. Users accounts created before this policy was enabled, and there is no change to the existing passwords, are not affected.
Minimum Number (%) of Characters Changed from Previous Password	Sets the minimum number in percentage of characters required to be changed from the previous password.
Disable Duplicate Login	Check this to prevent users from logging in with the same account at the same time.
Enforce Password History	Checking this box will require users to create a unique password that does not match the last x passwords used prior. X equals the number entered in the dialog box.

Device Assignment

When a user logs onto the KVM switch, the ports that they are allowed to access are displayed in the port list. Ports that they are not allowed to access are not displayed. Port access rights, as well as access to virtual media functionality and configuration settings, is assigned on a port-by-port basis in the user or group *Device* tab. To access the *Device* tab, you must pull up the user or group information page, and then click on the *Device* tab at the top-right of the page.

The *Device* tab page includes a list of the master KVM switch and its ports on the left, and three permission columns to the right of the list.

- *Access* – Determines if the account can access the port, and if so, whether they have *View Only* or *Full* access.
- *USB* – Determines if the account can access virtual media mounted to the port, and if so, whether they have *Read* or *Read/Write* access.
- *Config* – If the box is checked next to a port, the account is given access to edit the *Port Configuration* settings. (See *Port Configuration* section under *OSD Operation* for details.)

Note: For *Configuration* access to take effect, the account must also have been given *Port Configuration* permission. (See the *Adding User Accounts* section under *User Management* for details.)

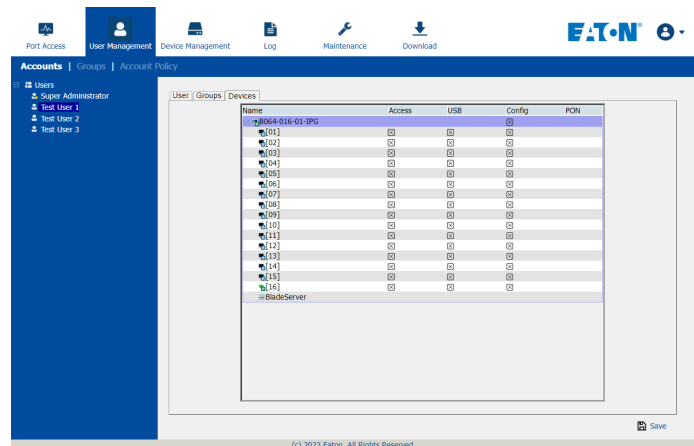

To assign device permissions, do the following:

1. Select the user/group name from the user/group list, or select the user/group name in the main panel and click the *Modify* button.
2. In the user/group notebook page that appears, click on the *Device* tab.
3. Click on the *Access*, *USB* or *Config* checkbox next to the desired port to toggle through the permission options. For the *Access* and *USB* columns, you can choose between full access, view only access or no access. For the *Config* column, you can choose between enabled or disabled. The permission types are exactly the same as those described in the *Access* sub-section. (See *Access* section for details.)
4. When you have finished assigning permissions, click the *Save* button.

Note: You can simultaneously assign port access to multiple ports using the [Shift] or [Ctrl] keys. To highlight a group of consecutive ports, start by highlighting the first port, hold down the [Shift] key, and then highlight the last port that you wish to highlight. All ports from the first one you highlighted to the last will be highlighted. You can then click on any of the permission checkboxes to change that permission for all of the highlighted ports. To highlight multiple non-consecutive ports, start by highlighting the first port, hold down the [Ctrl] key, and then highlight each additional port one by one while continuing to hold down the [Ctrl] key. When all of the desired ports are highlighted, click on any checkbox to change that permission for all of the highlighted ports.

OSD Operation

Device Management

The Device Management section allows Super Administrators, and Administrators/Users who have been given permission, to configure and control the KVM switch. When the Device Management icon is selected, it opens with the Device Information page displayed.

Note: If you do not have permission to configure the KVM switch, the Device Management icon will not appear when you log onto the KVM.

Device Information

The Device Information page displays general information about the settings of the KVM switch, and allows you to configure settings related to the KVM's dual power supplies and temperature sensors.

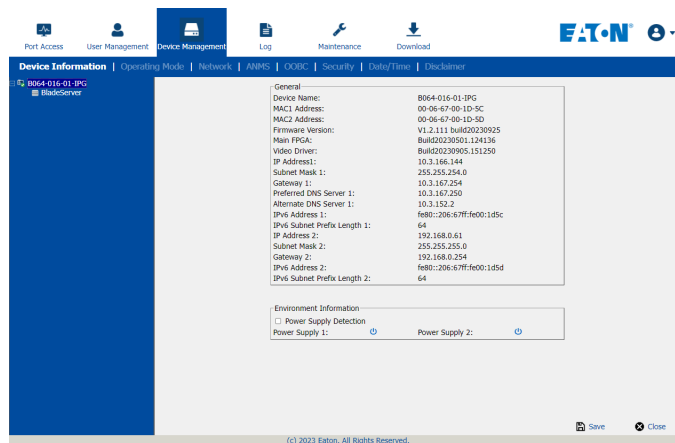

The following table describes the contents of the *Device Information* page.

Note: B064-008-01-IPG and B064-016-01-IPG KVMs Only – Power Supply Detection, Power Supply 1 and Power Supply 2 are the only Environment Information fields that are displayed.

Item	Description
Device Name	The port name assigned to the KVM switch is displayed here.
MAC1 Address	The B064- Series KVM switch contains two network interfaces. The MAC address of the first network interface is displayed here. The KVM MAC addresses are also displayed on the bottom panel of the KVM switch.
MAC2 Address	The B064- Series KVM switch contains two network interfaces. The MAC address of the second network interface is displayed here. The KVM MAC addresses are also displayed on the bottom panel of the KVM switch.
Firmware Version	The firmware version of the KVM switch is displayed here.
Main FPGA	The Main Field-Programmable-Gate-Array (FPGA) is displayed here.
Console FPGA	The Console Field-Programmable-Gate-Array (FPGA) is displayed here. Note: Does not apply to the B064-008-01-IPG & B064-016-01-IPG KVMs.
Video Driver	The Video Driver version is displayed here.
IP Address1	The IPv4 IP address of the first network interface is displayed here.
Subnet Mask 1	The IPv4 Subnet Mask of the first network interface is displayed here.
Gateway 1	The IPv4 Gateway of the first network interface is displayed here.
Preferred DNS Server 1	The IPv4 Preferred DNS Server of the first network interface is displayed here.
Alternate DNS Server 1	The IPv4 Alternate DNS Server of the second network interface is displayed here. Note: Applicable to the B064-008-01-IPG and B064-016-01-IPG KVMs only.
IPv6 Address 1	The IPv6 IP address of the first network interface is displayed here.
IPv6 Subnet Prefix Length 1	The IPv6 Subnet Prefix Length of the first network interface is displayed here.
Power Supply Detection	The B064- IPG KVM features dual power supplies. Checking this checkbox will cause the KVM to beep when receiving power from one source, and a message will appear on the local console screen asking you to confirm that you are aware of the situation.
Power Supply 1	The icon to the right of this is gray when power supply 1 is not receiving power. It is blue when power supply 1 is receiving power.
Power Supply 2	The icon to the right of this is gray when power supply 2 is not receiving power. It is blue when power supply 2 is receiving power.

OSD Operation

Operating Mode

The *Operating Mode* sub-section allows the working parameters of the KVM to be set. The settings in this sub-section are described in the table below.

Item	Description
Force All to Grayscale	When this checkbox is checked, all of the accounts in the installation will be forced to view the remote video in black and white. This can help improve keyboard and mouse response time on slower networks.
Enable Client AP Device List	When this checkbox is checked, the KVM switch will appear in the device list of the non-browser Windows and Java client main pages. If this checkbox is not checked, you will still be able to access the KVM via the non-browser clients, but you will have to manually type in the IP address instead of selecting it from the device list.
Enable First Logon Transfer	When this checkbox is checked, only the first user on a bus can switch ports. (See <i>Bus Info</i> section under <i>Control Panel</i> in <i>Remote Session Operation</i> for details.)
Keyboard/Mouse Broadcast	This drop-down menu allows you to broadcast the keyboard and/or mouse commands to all accessible computers at the same time. This functionality is disabled by default. Note: For the broadcast feature to function properly, all of the computers must be running the same OS, all monitors must be set to the same resolution, and the computer screens must have the same layout.
Console Keyboard Language	Select from the drop-down list the language of the keyboard that is connected to the KVM console port. This defaults at English US.

Network

The *Network* sub-section is where the KVMs network settings are entered.

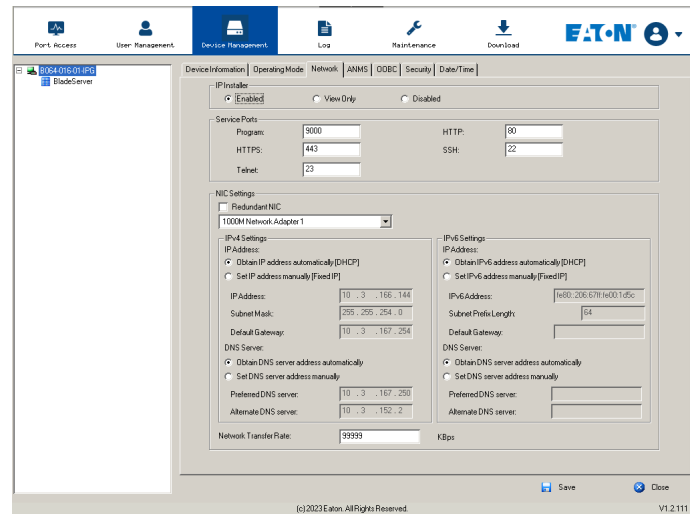

OSD Operation

Network

The settings in this sub-section are described in the table below.

Item	Description
IP Installer	<p>The B064-Series KVM switch comes with an IP Installer application that allows Windows computers to easily view and edit the KVM's network settings. This section determines what access the IP Installer has to the KVM switch.</p> <ul style="list-style-type: none"> • Enabled – When selected, the IP Installer can locate the KVM switch on the network and display its current IP address. It also allows the IP Installer to be used to change the IP address of the KVM switch. • View Only – When selected, the IP Installer can locate the KVM switch on the network and display its current IP address, but it cannot be used to change the IP address of the KVM switch. • Disabled – When selected, the IP Installer cannot locate the KVM switch on the network, nor can it be used to change the IP address of the KVM switch.
Service Ports	<p>This section allows you to set up port numbers that will be allowed by a firewall. If the port numbers on this page are not allowed access by the firewall, you will not be able to access the KVM switch. Valid entries for all of the service ports are from 1 to 65535.</p> <p>Note: You must enter a different port number for each field. If the KVM is connected to a network without a firewall, it doesn't matter what these ports are set to, as they will have no effect.</p> <ul style="list-style-type: none"> • Program – This is the port number that is used when accessing connected computers via the browser and non-browser Windows and Java clients. It is also the port number that is used when accessing virtual media. The default value is 9000. Note: This port number must match the port number in the non-browser Windows and Java clients when using them to connect to the KVM switch. • HTTP – This is the port that is used for a browser login. The default value is 80. • HTTPS – This is the port that is used for a secure browser login. The default is 443. • SSH – This is the port number that is used when accessing the KVM switch via SSH. The default value is 22. • Telnet – This is the port number that is used when accessing the KVM switch via Telnet. The default value is 23.
Redundant NIC	<p>The B064-Series KVM switch features two network interfaces. You can assign the same IP address to both, or assign a separate IP address for each. When this checkbox is checked, the same IP address gets assigned to both network interfaces, and the NIC drop-down menu below it is grayed out. If unchecked, the NIC drop-down menu is activated, and you must assign an IP address for each interface. Select a network interface from the drop-down to edit its settings.</p>
IPv4 Settings	<p>The B064-Series KVM switch supports both IPv4 and IPv6. If you wish to use an IPv6 IP address, ignore this section.</p> <ul style="list-style-type: none"> • Obtain an IP Address Automatically (DHCP) – When this option is checked, the KVM switch will have its IP address assigned to it by a DHCP server upon booting up, and the remaining fields in this section will be grayed out. This option is checked by default. • Set IP Address Manually (Fixed IP) – Check this option if you wish to assign an IP address to the KVM yourself. When checked, the settings fields below will be activated for you to edit. • IP Address – Enter in the desired IP address here. • Subnet Mask – Enter in the desired Subnet Mask here. • Default Gateway – Enter in the desired Default Gateway here. • Obtain DNS Server Address Automatically – When this option is checked, the KVM switch will have its DNS Server address assigned to it by a DHCP server upon booting up, and the remaining fields in this section will be grayed out. If you selected to set the IP address manually above, this option will be grayed out, and you will be required to enter the DNS Server address manually as well. • Set DNS Server Address Manually – Check this option if you wish to assign a DNS Server address to the KVM yourself. When checked, the settings fields below will be activated for you to edit. • Preferred DNS Server – Enter in the preferred DNS Server address here. • Alternate DNS Server – Enter in the alternate DNS Server address here. This is an optional field.
IPv6 Settings	<p>The B064-Series KVM switch supports both IPv4 and IPv6. If you wish to use an IPv4 IP address, ignore this section.</p> <ul style="list-style-type: none"> • Obtain IPv6 Address Automatically (DHCP) – When this option is checked, the KVM switch will have its IP address assigned to it by a DHCP server upon booting up, and the remaining fields in this section will be grayed out. This option is checked by default. • Set IPv6 Address Manually (Fixed IP) – Check this option if you wish to assign an IP address to the KVM yourself. When checked, the settings fields below will be activated for you to edit. • IPv6 Address – Enter in the desired IP address here. • Subnet Prefix Length – Enter in the desired Subnet Prefix length here. • Default Gateway – Enter in the desired Default Gateway here. • Obtain DNS Server Address Automatically – When this option is checked, the KVM switch will have its DNS Server address assigned to it by a DHCP server upon booting up, and the remaining fields in this section will be grayed out. If you selected to set the IP address manually above, this option will be grayed out, and you will be required to enter the DNS Server address manually as well. • Set DNS Server Address Manually – Check this option if you wish to assign a DNS Server address to the KVM yourself. When checked, the settings fields below will be activated for you to edit. • Preferred DNS Server – Enter in the preferred DNS Server address here. • Alternate DNS Server – Enter in the alternate DNS Server address here. This is an optional field.
Network Transfer Rate	<p>This setting allows you to set the size of the data transfer stream to match your network, by setting the rate at which the KVM transfers data to remote computers. The range is from 4 to 99,999 Kbps. The default is 99999.</p>

Advanced Network Management Settings

The ANMS sub-section is used to set up login authentication and authorization management from external sources. It is split up into two pages; *Event Destination* and *Authentication*, which are explained in the sections that follow.

Event Destination

The *Event Destination* page allows the KVM to be set up to record and send notifications of events that take place on the system. It allows you to enable and set up notification via SMTP, SNMP, Syslog Server and the Log Server.

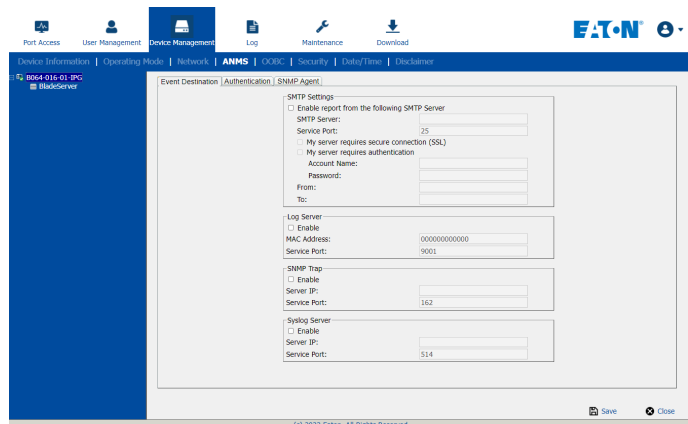

SMTP Settings

The SMTP Settings section allows you to have notifications of system events emailed to you via the SMTP server. To set up this feature, follow the steps below.

Note: The Notification Settings, described on page 54, must be enabled for notifications to be sent.

- Check the *Enable report from the following SMTP Server* checkbox.
- In the *SMTP Server* field, key in the IPv4 address, IPv6 address or domain name of the SMTP server.
- In the *Service Port* field, enter in a port that the firewall will allow to be used to access the log server. The valid port range is between 1 and 65535. The default port number is 25.
- If your server requires a secure SSL connection, check the *My server requires secure connection (SSL)* checkbox.
- If your server requires authentication, check the *My server requires authentication* checkbox.
- Enter in the *Account Name* and *Password* for your SMTP server.
- In the *From* field, key in the email address that you want the report to show up as being sent from.

Note: Only one email address is allowed in the *From* field, and it cannot exceed 64 Bytes. 1 Byte is equal to 1 English alphanumeric character.

- In the *To* field, key in the email address(es) you want the report to be sent to.

Note: If you are entering more than one address, separate them with a semicolon. The size of all email addresses cannot combine to more than 256 Bytes. 1 Byte is equal to 1 English alphanumeric character.

Log Server

In addition to the log that is built into the OSD, the KVM comes with an external Windows-based log server that can be installed on a computer. (See *The Log Server* section for details.) The *Log Server* section on this page is where the external log server can be enabled and set up for use. To do this, follow the steps below.

1. Check the *Enable* checkbox in the *Log Server* section.
2. In the *MAC Address* field, enter the MAC address of the computer that the log server resides on.
3. In the *Service Port* field, enter in a port that the firewall will allow to be used to access the log server. The valid port range is between 1 and 65535. The default port number is 9001.

Note: The port number entered here must not be the same as any of the ports entered into the *Network* sub-section. (See *Network* section under *Device Management* for details.)

SNMP Server

This section allows you to enable SNMP traps to be sent. To enable SNMP traps, do the following

Note: The Notification Settings, described on page 54, must be enabled for notifications to be sent:

1. Check the *Enable SNMP Agent* checkbox.
2. In the *Server IP* field, enter the IPv4 address, IPv6 address or domain name of the computer to be notified of SNMP trap events.
3. In the *Service Port* field, enter in a port that the firewall will allow to be used to access the SNMP server. The valid port range is between 1 and 65535. The default port number is 162.

Note: The port number entered here must not be the same as any of the ports entered into the *Network* sub-section. (See *Network* section under *Device Management* in *OSD Operation* for details.)

Syslog Server

To record all the events that take place on the KVM and write them to a Syslog server, do the following

Note: The Notification Settings, described on page 54, must be enabled for notifications to be sent:

1. Check the *Enable* checkbox in the *Syslog Server* section.
2. In the *Server IP* field, enter the IPv4 address, IPv6 address or domain name of the Syslog server.
3. In the *Service Port* field, enter in a port that the firewall will allow to be used to access the Syslog server. The valid port range is between 1 and 65535. The default port number is 514.

Note: The port number entered here must not be the same as any of the ports entered into the *Network* sub-section. (See *Network* section under *Device Management* in *OSD Operation* for details.)

Advanced Network Management Settings

Authentication

The *Authentication* page allows remote authentication to be set up via RADIUS and LDAP/S.

Disable Local Authentication

Check this checkbox to disable local login authentication of the KVM switch. If checked, the switch can only be accessed using LDAP, LDAPS, MS Active Directory, NetDirector (ND) management and/or RADIUS authentication.

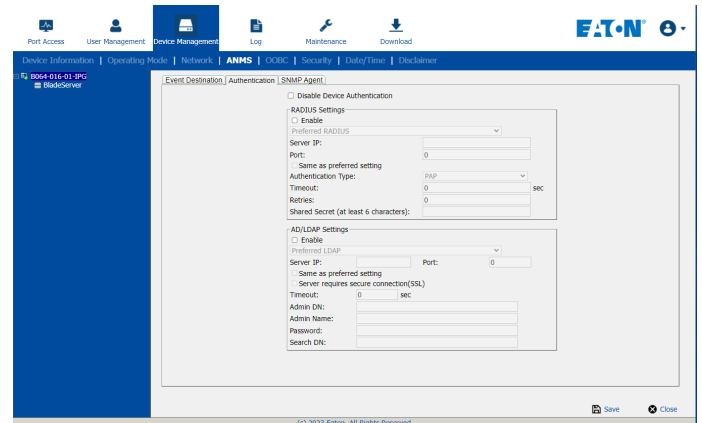

RADIUS Settings

To allow authentication and authorization for the B064-Series KVM over IP switch through a RADIUS server, do the following:

1. Check the **Enable** check box in the RADIUS Settings sections.
2. Select Preferred or Alternate RADIUS server from the dropdown menu.
3. Fill in the IP address and service port number for either the Preferred or Alternate RADIUS server. You can use the IPv4 address, the IPv6 address or the domain name in the *Server IP* field.
4. Select the *Authentication Type*: PAP (Password Authentication Protocol) or CHAP (Challenge-Handshake Authentication Protocol) from the drop-down menu.
5. In the *Timeout* field, set the time in seconds that the KVM over IP switch waits for a RADIUS server reply before it times out.
6. In the *Retries* field, set the number of allowed RADIUS retries.
7. In the *Shared Secret* field, key in the character string that you want to use for authentication between the B064-Series KVM over IP switch and the RADIUS server. A minimum of 6 characters is required.

On the RADIUS server, set the entry for each user as su/xxxx, where xxxx represents the username assigned to the user in the KVM switch. User access rights will be the same as those that were assigned to them in the KVM switch. (See User Management sections for details).

AD / LDAP Authentication and Authorization Settings

To allow authentication and authorization for the B064 Series KVM Switch via AD / LDAP, refer to the information in the table, below:

Character	Meaning
Enable	Check the Enable checkbox to allow AD/LDAP authentication and authorization.
Preferred/ Alternative LDAP	From the drop-down menu, specify either Preferred LDAP or Alternative LDAP.
Server IP	Fill in the IP address of the Preferred or Alternate LDAP server.
Port	Fill in the port number of the Preferred or Alternate LDAP server. For LDAP, the default port number is 389.
Timeout	Set the time in seconds that the B064-Series KVM Switch waits for an LDAP server reply before timing out.
Admin DN	Consult the LDAP administrator to ascertain the appropriate entry for this field. For example, the entry might look like this: ou=b064-032-04-ip,dc=tripplite,dc=com
Admin Name	Fill in the LDAP administrator's username.
Password	Fill in the LDAP administrator's password.
Search DN	Set the distinguished name of the search base. This is the domain name where the search starts for user names.

Note: If the LDAP Setting is enabled, the LDAP schema for MS Active Directory must be extended, or an OpenLDAP server must be installed and configured. (See LDAP Server Configuration, in the following section for details.)

Advanced Network Management Settings

LDAP Configuration — Active Directory

To allow authentication and authorization for the B064-Series KVM Switch via LDAP, the Active Directory's LDAP *Schema* must be extended so that an extended attribute name for the B064-Series KVM Switch – **userprofile** – is added as an optional attribute to the *person* class.

- *Authentication* refers to determining the authenticity of the person logging in.
- *Authorization* refers to assigning permission to use the device's various features.

In order to configure the LDAP server, you will have to complete the following procedures: 1) Install the Windows 2003 Support Tools; 2) Install the Active Directory Schema Snap-in; and 3) Extend and Update the Active Directory Schema.

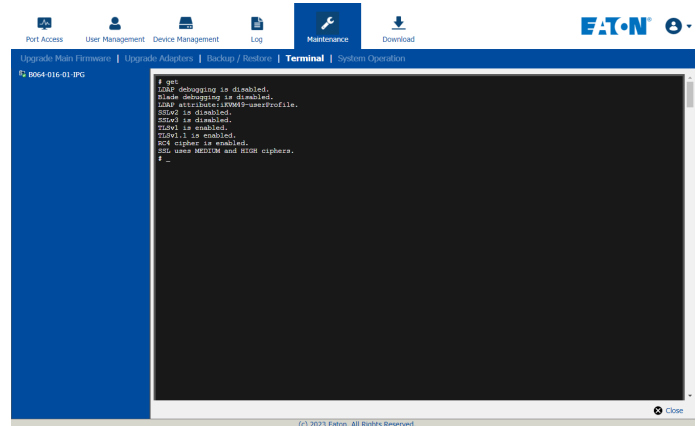

Note: To quickly access the LDAP attribute, users can type the word get into the Terminal command line.

Install the Windows 2003 Support Tools

1. On your Windows Server CD, open the **Support** → **Tools** folder.
2. In the right panel of the dialog box that comes up, double click *SupTools.msi*.
3. Follow along with the Installation Wizard to complete the procedure.

Install the Active Directory Schema Snap-in

1. Open a Command Prompt.
2. Key in `regsvr32 schmmgmt.dll` to register `schmmgmt.dll` on your computer.
3. Open the *Start* menu. Click *Run* and key in `mmc /a`. Click *OK*.
4. On the *File* menu of the screen that appears, click *Add/Remove Snap-in*, then click *Add*.
5. Under *Available Standalone Snap-ins*, double click *Active Directory Schema*, click *Close* and click *OK*.
6. On the screen you are in, open the *File* menu and click *Save*.
7. For *Save in*, specify the `C:\Windows\system32` directory.
8. For *File name*, key in `schmmgmt.msc`.
9. Click *Save* to complete the procedure.

Creating a Start Menu Shortcut Entry

To create a shortcut entry on the Start Menu for the Active Directory Schema, do the following:

1. Right click *Start*; select: **Open all Users** → **Programs** → **Administrative Tools**.
2. On the *File* menu, select **New** → **Shortcut**
3. In the dialog box that comes up, browse to or key in the path to `schmmgmt.msc` (`C:\Windows\system32\schmmgmt.msc`) and click *Next*.
4. In the dialog box that comes up, key in *Active Directory Schema* as the name for the shortcut, then click *Finish*.

Advanced Network Management Settings

Extend and Update the Active Directory Schema

Step 1 - Create a New Attribute:

- a) Open **Control Panel** → **Administrative Tools** → **Active Directory Schema**.

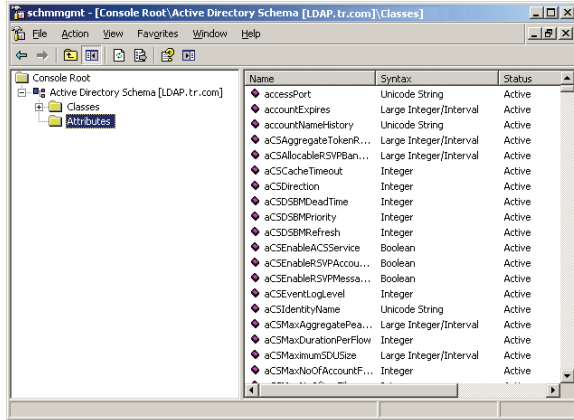

- b) In the left panel of the screen that comes up, right-click **Attributes**:

- c) Select **New** → **Attribute**.

- d) In the warning message that appears, click **Continue** to bring up the **Create New Attribute** dialog box.

- e) Fill in the dialog box according to the example below and click **OK** to complete step 1 of the procedure.

- **Common Name** – userprofile
- **LDAP Display Name** – userprofile
- **Syntax** – Unicode String
- **Minimum** – 1
- **Maximum** – 255

Note: The Unique X500 Object ID uses periods, not commas.

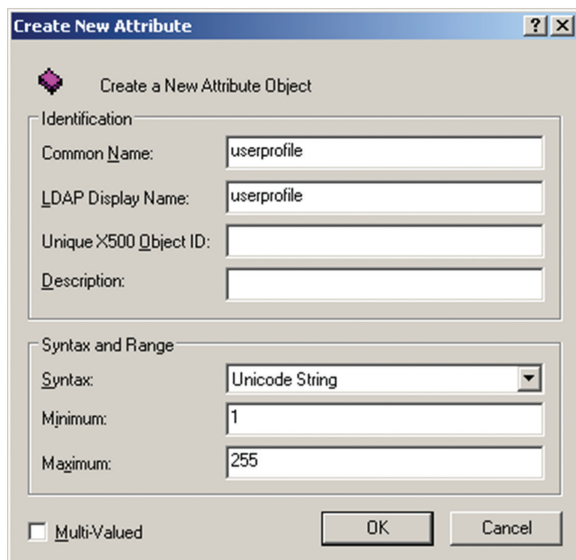

Step 2 - Extend the Object Class With the New Attribute:

- a) **Open Control Panel** → **Administrative Tools** → **Active Directory Schema**.

- b) In the left panel of the screen that comes up, select **Classes**.

- c) In the right panel, right-click **person**:

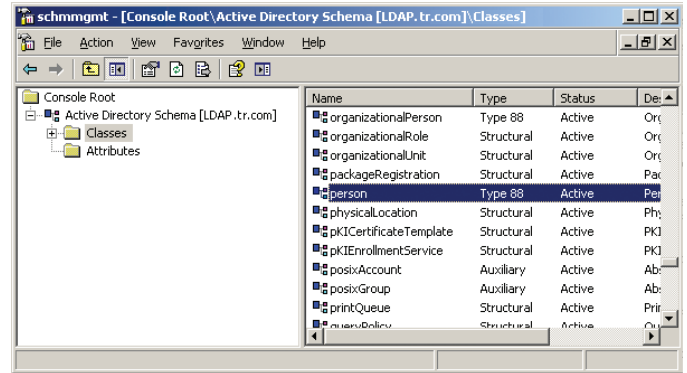

- d) Select **Properties**; the **person Properties** page comes up with the **General** tab displayed. Click the **Attributes** tab.

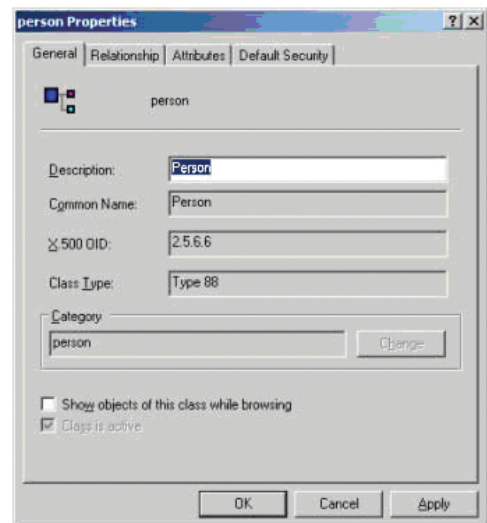

- e) Select the **Attributes** tab and click the **Add** button:

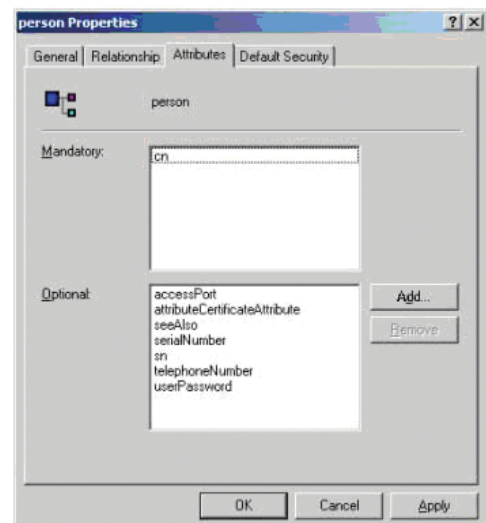

Advanced Network Management Settings

f) In the list that comes up, select *userprofile*, then click *OK* to complete step 2 of the procedure.

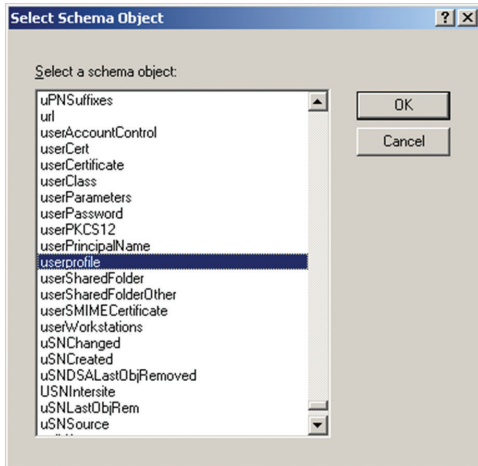

Step 3 - Edit Active Directory Users With the Extended Schema:

a) Run **ADSI Edit**. (Installed as part of the *Support Tools*.)

b) Open *Domain*, and navigate to the *cn=users dc=tripplite dc=com* node.

c) Locate the user you wish to edit.

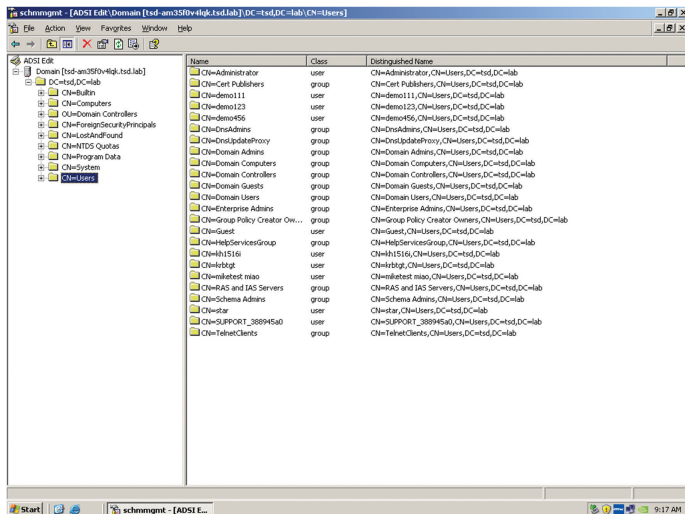

d) Right-click on the user's name and select *Properties*.

e) On the *Attribute Editor* page of the dialog box that appears, select *userprofile* from the list.

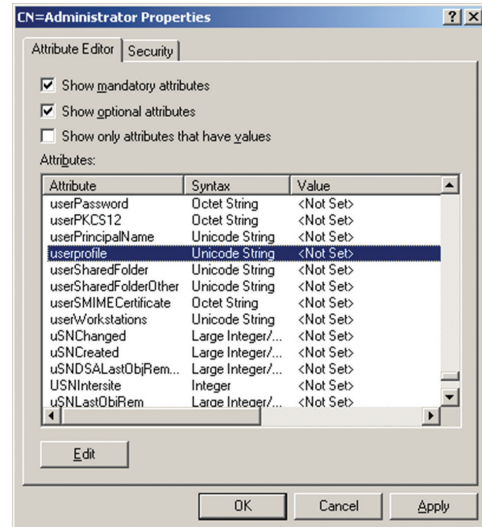

f) Click *Edit* to bring up the *String Attribute Editor*:

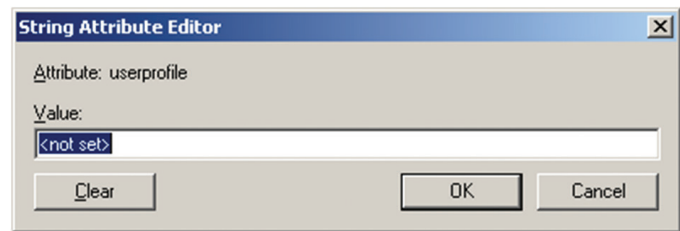

g) Replace the value shown with *su/xxxx*, where *xxxx* represents the username assigned to the user in the KVM switch. User access rights will be the same as those that were assigned to them in the KVM switch. (See *User Management* section for details.)

Advanced Network Management Settings

h) Click *OK*. When you return to the *Attribute Editor* page, the *userprofile* entry now reflects the new permissions:

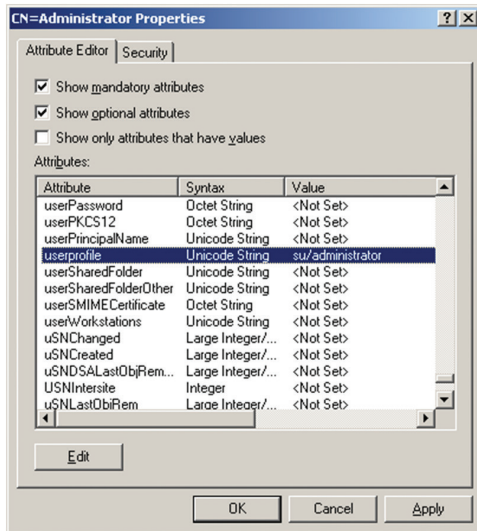

i) Click *Apply* to save the change and complete the procedure.

j) Repeat Step 3 (*Edit Active Directory Users With the Extended Schema*) for any other users you wish to add.

OpenLDAP Server

OpenLDAP is an Open source LDAP server designed for UNIX platforms. A Windows version can be downloaded from:

http://download.bergmans.us/openldap/openldap-2.2.29/openldap-2.2.29-db-4.3.29-openssl-0.9.8awin32_Setup.exe

OpenLDAP Server Installation

After downloading the program, launch the installer, select your language, accept the license and choose the target installation directory. The default directory is:

`c:\Program Files\OpenLDAP.`

When the *Select Components* dialog box appears, select *install BDB-tools* and *install OpenLDAP-slapd as NT service*, as shown in the diagram, below:

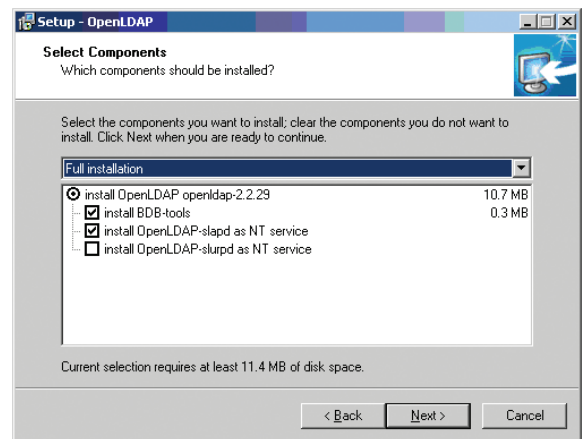

Advanced Network Management Settings

OpenLDAP Server Configuration

The main OpenLDAP configuration file, `slapd.conf`, has to be customized before launching the server. The modifications to the configuration file will do the following:

- Specify the Unicode data directory. The default is `./ucdata`.
- Choose the required LDAP schemas. The core schema is mandatory.
- Configure the path for the OpenLDAP `pid` and `args` start up files. The first contains the server pid, the second includes command line arguments.
- Choose the database type. The default is `bdb` (Berkeley DB).
- Specify the server suffix. All entries in the directory will have this suffix, which represents the root of the directory tree. For example, with suffix `dc=tripplite,dc=com`, the fully qualified name of all entries in the database will end with `dc=tripplite,dc=com`.
- Define the name of the administrator entry for the server (`rootdn`), along with its password (`rootpw`). This is the server's super user. The `rootdn` name must match the suffix defined above. (Since all entry names must end with the defined suffix, and the `rootdn` is an entry)

An example configuration file is provided in the figure, below:

```
ucdata-path ./ucdata
include ./schema/core.schema

pidfile ./run/slapd.pid
argsfile ./run/slapd.args

database bdb
suffix "dc=eaton, dc=com"
rootdn "cn=Manager, dc=eaton, dc=com"
rootpw secret
directory ./data
```

Starting the OpenLDAP Server

To start the OpenLDAP Server, run **slapd** (the OpenLDAP Server executable file) from the command line. **slapd** supports a number of command line options, the most important option is the **d** switch that triggers debug information. For example, a command of `slapd -d 256` would start OpenLDAP with a debug level of 256, as shown in the following screenshot:

Note: For details about **slapd** options and their meanings, refer to the [OpenLDAP documentation](#).

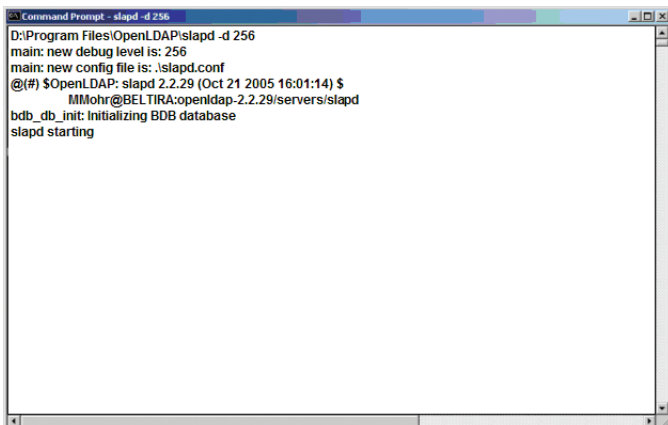

```
Command Prompt - slapd -d 256
D:\Program Files\OpenLDAP\slapd -d 256
main: new debug level is: 256
main: new config file is: ./slapd.conf
@(#) $OpenLDAP: slapd 2.2.29 (Oct 21 2005 16:01:14) $
MMohr@BELTIRA:openldap-2.2.29/servers/slapd
bdb_db_init: Initializing BDB database
slapd starting
```

Customizing the OpenLDAP Schema

The schema that **slapd** uses may be extended to support additional syntaxes, matching rules, attribute types, and object classes. In the case of the B064-Series KVM Switch, the B064-Series KVM Switch `User` class and the `permission` attribute are extended to define a new schema. The extended schema file used to authenticate and authorize users logging in to the B064-Series KVM Switch is shown in the figure, below:

```
attributetype(1.3.6.1.4.1.21317.1.1.4.2.2
Name 'B020-U16-19-IP-AccessRight'
EQUALITY caseIgnore.Match
SUBSTR caseIgnoreSubstringsMatch
SYNTAX 1.3.6.1.4.1466.115.121.1.15
SINGLE-VALUE
)

objectclass(1.3.6.1.4.1.21317.1.1.4.1.2
NAME 'User'
SUP organizationalPerson
STRUCTURAL
MAY (B020-U16-19-IP-AccessRight $userCertificate)
)
```

LDAP DIT Design and LDIF File

LDAP Data Structure

An LDAP Directory stores information in a tree structure known as the Directory Information Tree (DIT). The nodes in the tree are directory entries, and each entry contains information in attribute-value form. An example of the LDAP directory tree for the B064-Series KVM Switch is shown in the figure below:

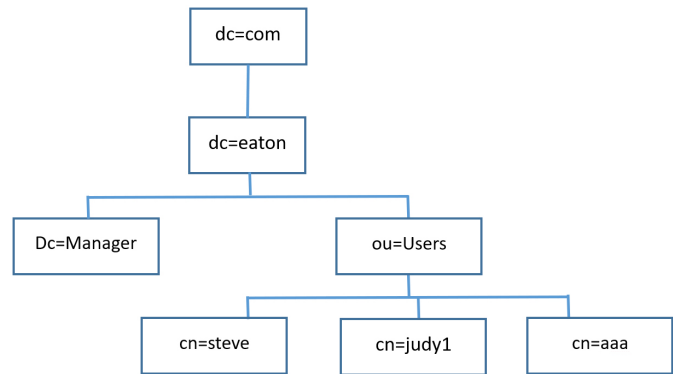

Advanced Network Management Settings

DIT Creation

The LDAP Data Interchange Format (LDIF) is used to represent LDAP entries in a simple text format (please refer to RFC 2849). The figure below illustrates an LDIF file that creates the DIT for the B064-Series KVM Switch directory tree (shown in the figure in the previous section).

```
dn: dc=eaton, dc=com
objectclass: top
objectclass: dcObject
objectclass: organization

dn: cn=Manager,dc=eaton,dc=com
objectclass: top
objectclass: person
objectclass: organizationalPerson
cn: Manager
sn: Manager

dn: ou=Users, dc=eaton, dc=com
objectclass: top
objectclass: organizationalUnit
ou: Users

dn: cn=steve, ou=Users, dc=eaton, dc=com
objectclass: top
objectclass: person
objectclass: organizationalPerson
objectclass: User
cn: steve
sn: steve
B020-U16-19-IP-AccessRight: w,v,p,j,c,l
userPassword: password
ou: Users
```

The following figure illustrates an LDIF file that defines the OpenLDAP group for the B064-Series KVM Switch.

```
dn: cn=judy1, ou=Users, dc=eaton, dc=com
objectclass: top
objectclass: person
objectclass: organizationalPerson
objectclass: User
cn: judy1
sn: judy1
userPassword:password

dn: cn=ccc, dc=eaton, dc=com
objectclass: groupOfNames
cn: ccc
member: cn=judy1, cn=users, dc=eaton, dc=com

dn: cn=bbb, dc=eaton, dc=com
objectclass: groupOfNames
cn: bbb
member: cn=ccc, dc=eaton, dc=com
```

```
dn: cn=aaa, dc=eaton, dc=com
objectclass: groupOfNames
cn: aaa
member: cn=bbb, dc=eaton, dc=com
```

Using the New Schema

To use the new schema, do the following:

1. Save the new schema file (e.g., B064-Series KVM switch. schema) in the /OpenLDAP/ schema/ directory.
2. Add the new schema to the slapd.conf file, as shown in the figure:
3. Restart the LDAP server.
4. Write the LDIF file and create the database entries in init. Ifid with the *Idapadd* command, as shown in the following example:

```
Idapdd -f init.ldif -x -D "cn=Manager,dc=eaton,dc=com" -Wsecret
```

```
ucdata-path ./ucdata
include      ./schema/core.schema
include      ./schema/cosine.schema
include      ./schema/inetorgperson.schema
include      ./schema/openldap.schema
include      ./schema/.schema
```

```
#Define global ACLs to disable default read access.
access to dn. children="ou=Users, dc=eaton, dc=com"
by: dn="cn=Manager, dc=eaton,dc=com"write
by: selfread
by: anonymous auth
by* none
```

```
pidfile      ./run/slapd.pid
argfile      ./run/slapd.args
```

```
#####
# BDB database definitions
#####
```

```
database     bdb
suffix       "dc=eaton, dc=com"
rootdn       "cn=Manager,dc=eaton,dc=com"
rootpw       secret
directory    ./data
```

SNMP Agent

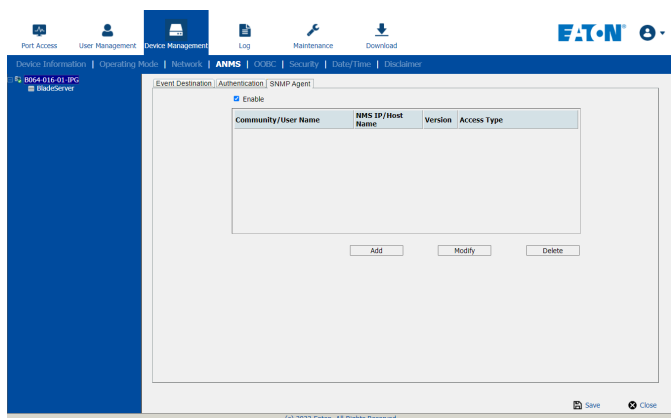

To set SNMP Agent, do the following:

1. Check *Enable*.
2. Click *Add*. A window appears.

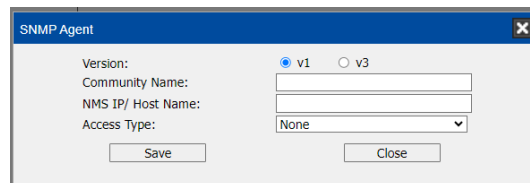

3. Select the Version.
4. Key in the Community Name.
5. Key in NMS IP/Host Name.
6. Select the Access Type and click *Save*.

OSD Operation

OOBC

In case the B064-Series KVM switch cannot be accessed via the LAN, it can be accessed via the switch's modem port. To enable support for PPP (modem) operation, check the *Enable Out of Band Access* checkbox. When checked, *Enable Dial Back* and *Enable Dial Out* functions become available.

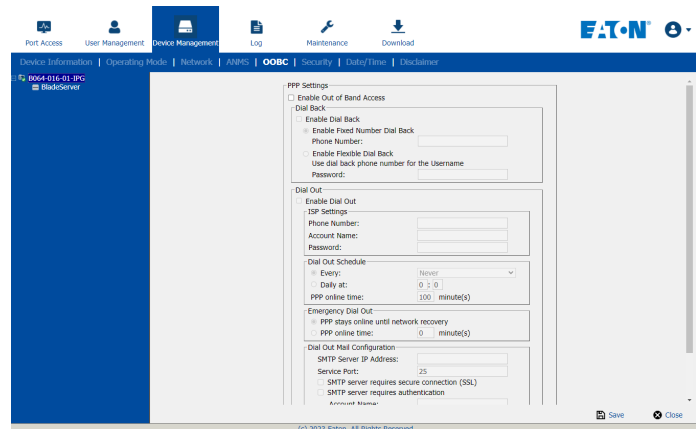

Enable Dial Back

If the *Enable Dial Back* checkbox is checked, the switch will disconnect calls that dial into it, and dial back to one of the entries specified in the table below.

Setting	Description
Enable Fixed Number Dial Back	When the <i>Enable Fixed Number Dial Back</i> checkbox is checked, the KVM will hang up on the modem when there is an incoming call, and dial back to the modem represented by the phone number mentioned in the <i>Phone Number</i> field.
Enable Flexible Dial Back	When the <i>Enable Flexible Dial Back</i> checkbox is checked, the KVM can dial back to any modem specified by the user connecting to the KVM. Simply enter a password into the <i>Password</i> field, and when a user connects to the KVM, they will be prompted to enter a username and password. They should enter the phone number of the modem that they want to dial back to as the username, and use the password that is set in the <i>Password</i> field as the password.

Enable Dial Out

To use the dial out feature, you must establish an account with an Internet Service Provider (ISP), and use a modem to dial out to your ISP account. Check the *Enable Dial Out* checkbox to enable this feature. The settings found in this section are described in the table below.

Setting	Description
ISP Settings	Enter in the <i>Phone Number</i> , <i>Account Name</i> and <i>Password</i> that you use to connect to your ISP here.
Dial Out Schedule	This section allows you to determine what times your KVM switch will dial out over your ISP connection. <ul style="list-style-type: none"> <i>Every</i> – Check this option to choose between the 5 options in the drop-down menu; <i>Never</i>, every <i>Hour</i>, every <i>2 Hours</i>, every <i>3 Hours</i> or every <i>4 Hours</i>. <i>Daily at</i> – Check this option to enter in a time that the KVM will dial out over your ISP every day. Use the hh:mm format to specify the desired time. <i>PPP Online Time</i> – Enter in the amount of time you want a ISP connection to last before it is terminated. A setting of 0 means that the ISP connection will not automatically disconnect itself.
Emergency Dial Out	In the event that the KVM gets disconnected from the network, or the network goes down, this feature will automatically connect via the ISP dial up connection. <ul style="list-style-type: none"> <i>PPP Stays Online Until Network Recovery</i> – When this option is checked, the ISP connection will remain active until the network connection is reestablished. <i>PPP Online Time</i> – When this option is checked, the ISP connection will remain active for the amount of time you set here. A setting of 0 means that the ISP connection will not automatically disconnect itself.
Dial Out Mail Configuration	This section allows you to set up email notifications of systems events via SMTP server. These notifications will be sent over the ISP network connection, in contrast to the notifications set up in ANMS Event Destination (see SMTP Settings), which go out over the standard network. <ul style="list-style-type: none"> <i>SMTP Server IP Address</i> – Enter the IPv4 address, IPv6 address or domain name of you SMTP server here. <i>SMTP Server Requires Secure Connection (SSL)</i> – Check this checkbox if your server requires a secure SSL connection. <i>SMTP Server Requires Authentication</i> – Check this checkbox if your server requires authentication. When checked, the Account Name and Password fields are activated. Enter in the Account Name and Password for your SMTP server. In the <i>From</i> field, key in the email address that you want the report to show up as being sent from. <p>Note: Only one email address is allowed in the <i>From</i> field, and it cannot exceed 64 Bytes. 1 Byte is equal to 1 English alphanumeric character.</p> In the <i>To</i> field, key in the email address(es) you want the report to be sent to. <p>Note: If you are entering more than one address, separate them with a semicolon. The size of all email addresses cannot combine to more than 256 Bytes. 1 Byte is equal to 1 English alphanumeric character.</p>

When you are done making all of your changes, click the Save button.

OSD Operation

OABC

Follow the steps below to setup and access the B064-Series KVM Switch via dial-in modem:

1. Set up your hardware configuration to match the diagram below. You will need to use Cat5e cable and the included RJ45 to DB9 Adapter to connect the B064-Series KVM Switch's modem port to the modem.
2. From your computer, use your modem terminal program to dial into the B064-Series KVM Switch's modem.

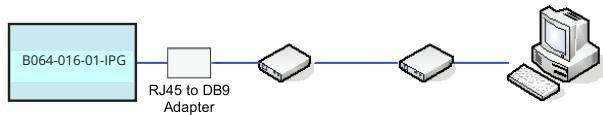

Note: If you don't know the B064-Series KVM Switch modem's serial parameters, get them from the system administrator. An example of setting up a modem terminal program under Windows XP is provided on the next page.

3. Once the connection is established, open your browser, and specify 192.168.192.1 in the URL box.

Note: The default username and password are blank.

From here, operation is the same as if you had logged in from a browser or with the AP programs.

Connection Setup Example (Windows XP)

To set up a dial-in connection to the B064-Series KVM Switch under Windows XP, do the following:

1. From the Start menu, select **Control Panel** → **Network Connections** → **Create a New Connection**.
2. When the Welcome to the New Connection Wizard dialog box appears, click *Next* to move on.
3. In the Network Connection Type dialog box, select Connect to the network at my workplace and click *Next*.
4. In the Network Connection dialog box, select Dial-up connection and click *Next*.
5. In the Connection Name dialog box, key in a name for the connection and click *Next*.
6. In the Connection Availability dialog box, you can select either Anyone's use or My use only, depending on your preferences, then click *Next*.
7. In the Phone Number to dial dialog box, key in the phone number of the modem connected to the B064 Series KVM Switch (be sure to include country and area codes, if necessary), then click *Next*.
8. In the Completing the New Connection Wizard dialog box, check Add a shortcut to this connection on my desktop and click *Finish*.

This completes the connection setup. Double click the desktop shortcut icon to make a dial-in connection to the B064-Series KVM Switch.

Security

The following section describes the settings found in the *Security* sub-section.

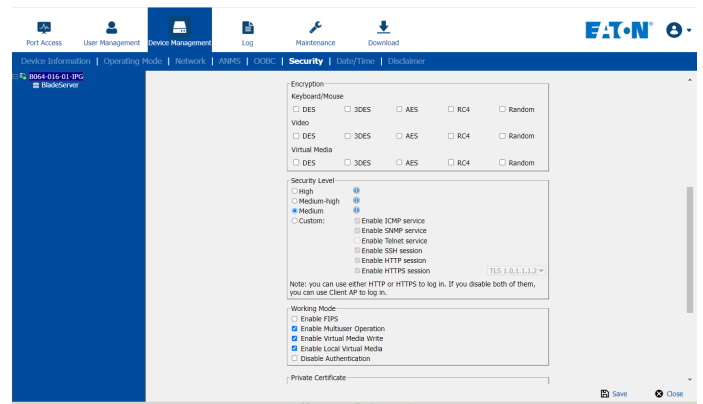
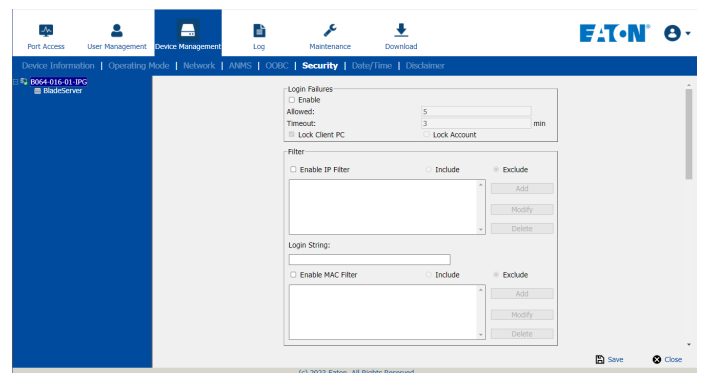

OSD Operation

Security

Login Failures

The *Login Failures* section allows you to set up the parameters for what occurs when an account fails to login successfully. To enable the settings entered here, check the *Enable* checkbox. The table below describes the settings found in this section.

Note: When the Login Failures settings are disabled, there is no restriction on the number of login failures. It is strongly recommended that you enable these features, and that both the Lock Client PC and Lock Account settings are enabled.

Setting	Description
Allowed	Determines the number of failed login attempts an account gets before they are prevented from accessing the KVM switch.
Timeout	Determines the amount of time that the user is prevented from accessing the KVM switch after exceeding the maximum number of failed login attempts.
Lock Client PC	When this checkbox is checked, the computer used to unsuccessfully access the KVM will be locked out after exceeding the maximum number of failed login attempts. Note: This feature blocks the computer using its IP address. If the computer IP address is changed, it will be able to access the KVM in spite of this setting.
Lock Account	When this checkbox is checked, the account used to unsuccessfully access the KVM will be locked out after exceeding the maximum number of failed login attempts.

Filtering

To enable IP and/or MAC filtering, click the *IP Filter Enable* and/or *MAC Filter Enable* checkbox. There are a maximum of 100 filters allowed for each.

- If the *include* button is checked, all the addresses within the filter range are allowed access to the B064-Series KVM Switch; all other addresses are denied access.
- If the *exclude* button is checked, all the addresses within the filter range are denied access to the B064-Series KVM Switch; all other addresses are allowed access.

IP Filtering

To add an IP filter:

1. Check the *IP Filter Enable* check box.
2. Click *Add*. A dialog box similar to the one below appears:

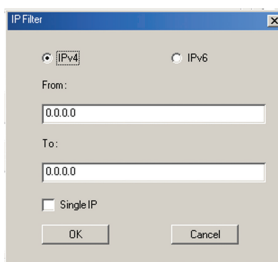

3. Check the IPv4 or IPv6 option, depending on what type of address you are filtering.

Note: You must access the OSD via the local console or one of the non-browser clients in order to filter an IPv6 address. When accessing the OSD via browser, you are only able to set up IPv4 filters.

4. To filter a single IP address, check the *Single IP* checkbox and enter the IP address you want to filter in the *From* field.

Note: This feature is not available when accessing the OSD via browser. To filter a single IP address via the browser OSD, you must enter in the same IP address in both the *From* and *To* fields.

5. To filter a range of IP addresses, enter the starting IP address in the *From* field, and the ending IP address in the *To* field.
6. After filtering in the addresses, click *OK*.
7. Repeat these steps for any additional IP addresses you want to filter.

To delete an IP filter:

Select the desired IP filter from the list and click *Remove*.

To modify an IP filter:

1. Select the desired IP filter from the list and click *Edit*. An *Edit* dialog box similar to the *Add* dialog box will appear.
2. Delete the old start IP address and replace it with the new one.
3. Delete the old end IP address and replace it with the new one. Click *OK*.

Note: To block a computer from accessing the B064-Series KVM Switch, you do not need to filter both its IP address and its MAC address. Any computer blocked by an IP filter will be denied access to the KVM switch, even if the computer is allowed to access the KVM switch under the MAC filters that are set up.

Security

Login String

The *Login String* allows the KVMs IP address to be more secure by adding extra text to the end of it. When text is entered into the *Login String* field, users will need to include a forward slash (/) and the *Login String* at the end of the URL to access the KVM switch. For example, if a *Login String* of *abcdefg* is entered, the user must enter a URL such as *192.168.0.126/abcdefg*.

The following characters are allowed in the login string:
0 through 9, a through z, A through Z, ~ ! @\$%^&*()_+'<>.,|

The following characters are not allowed:
%":/ ?#\ [Space]

Note: If a *Login String* is not entered, anyone can access the KVM switch using the IP Address alone, making the installation less secure.

Encryption

This section allows you to set different encryption settings for the *Keyboard/Mouse*, *Video* and *Virtual Media* functions of the KVM switch. You can choose any combination of encryption methods (DES, 3DES, AES and/or RC4), you can choose to randomly switch between them or you can choose no encryption at all. Although enabling encryption will add more security to your installation, it can also slow down system performance (mouse, keyboard, video), with the following having the most impact:

- RC4 impacts performance the least out of the four encryption methods. DES is second to least in impact, followed by 3DES and AES.
- Of all the possible combinations, a combination of RC4 and DES impacts performance the least.

MAC Filtering

To add a MAC filter:

1. Click *Add*. A dialog box similar to the one below appears:

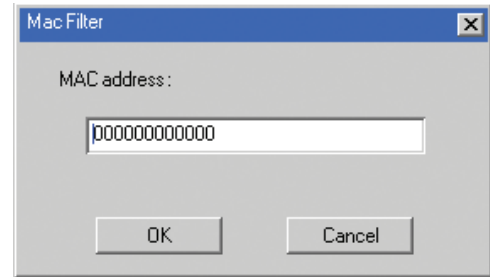

2. Type in the desired MAC address and click *OK*.
3. Repeat these steps for any additional MAC addresses you want to filter.

To delete a MAC filter:

Select the desired MAC filter from the list and click *Remove*.

To modify a MAC filter:

1. Select the desired MAC filter from the list and click *Edit*. An *Edit* dialog box appears.
2. Delete the old address and replace it with the new one. Click *OK*.

Note: To block a computer from accessing the B064-Series KVM Switch, you do not need to filter both its IP address and its MAC address. Any computer blocked by a MAC filter will be denied access to the KVM switch, even if the computer is allowed to access the KVM switch under the IP filters that are set up.

If any filters have been configured, they appear in the IP Filter and/or MAC Filter list boxes.

Security

Security Level

For increased security, you can check or uncheck the boxes to High, Medium-high, Medium or Custom security features.

1. High (Disable all services except: SSHv2, HTTPS(TLS v1.2))
2. Medium-high (Enable SSHv2, redirect HTTP or HTTPS, HTTPS(TLS v1.2), ICMP)
3. Medium (Enable SSHv2, redirect HTTP or HTTPS, HTTPS (TLS v1.0, 1.1, 1.2), SNMP Agent, ICMP) (Default)
4. Custom: Click to check the following security options you wish to apply:
 - Enable ICMP service
 - Enable SNMP service
 - Enable Telnet service
 - Enable SSH session
 - Enable HTTP session
 - Enable HTTPS session
(Select between TLS 1.2 or TLS "1.0, 1.1,1.")

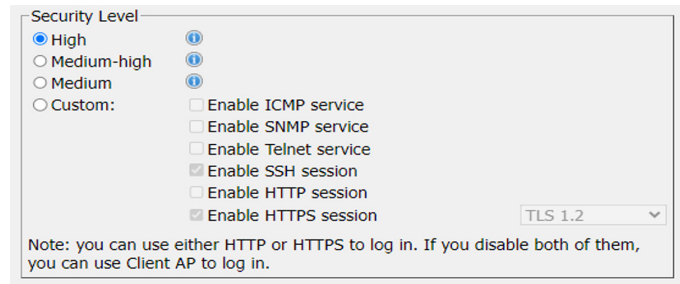

Working Mode

The *Working Mode* section allows you to enable/disable operation features of the KVM switch. The table below describes the available settings.

Setting	Description
Enable FIPS	Enables the FIPS security standard.
Enable Multiuser Operation	When this box is checked, multiple accounts (up to 32) can log onto the same bus (see <i>Bus Info</i> section under <i>Control Panel</i> in <i>Remote Session Operation</i> for details) at the same time. If not selected, the KVM switch can only be simultaneously accessed by the number of users that the unit has buses for. The B064-016-02-IPG and B064-032-02-IPG have 3 buses each (1 local, 2 remote), and the B064-016-04-IPG and B064-032-04-IPG have 5 buses each (1 local, 4 remote).
Enable Virtual Media Write Operation	When this box is checked, applicable virtual media (see <i>Virtual Media</i> section under <i>Control Panel</i> in <i>Remote Session Operation</i> for details) will be able to have information written to it from the remote computer. If this box is not checked, any virtual media mounted to a remote computer will only be able to be viewed, and not written to.
Enable Local Virtual Media	When this box is checked, applicable USB media (see <i>Virtual Media</i> section under <i>Control Panel</i> in <i>Remote Session Operation</i> for details) can be connected to the USB ports on the front of the KVM switch and accessed on the connected computers. If this box is not checked, USB media connected to the KVM will not be accessible on the connected computers.
Disable Authentication	When this box is checked, no authentication procedures are used to check accounts logging into the KVM. All users will be logged onto the KVM switch with full access, regardless of what account type they are. Note: Enabling this setting creates a very unsecure situation, and is not recommended.

Private Certificate

When logging into the KVM switch over a secure (SSL) connection, a certificate is required to ensure you are logging into a secure site. If a certificate is not recognized as secure, you will be prompted each time you log in to verify you want to continue to the website. This section allows you to import an *Encryption Key* and *Certificate*. To import an *Encryption Key* and *Certificate*, follow the steps below.

1. Click the *Browse* button to the right of *Private Key*, browse to where your private encryption key file is located, and then select it.
2. Click the *Browse* button to the right of *Certificate*, browse to where your certificate file is located, and then select it.
3. Click the *Upload* button to complete the procedure.

Note: Both the *Private Key* and *Certificate* must be imported at the same time. Clicking the *Restore Default* button returns the KVM to the default certificate that came installed on it.

OSD Operation

Security

Certificate Signing Request

The *Certificate Signing Request* section provides an automated way of obtaining and installing a CA signed SSL server certificate. To perform this operation, follow the steps below.

1. Click the *Create CSR* button. The following dialog box appears.

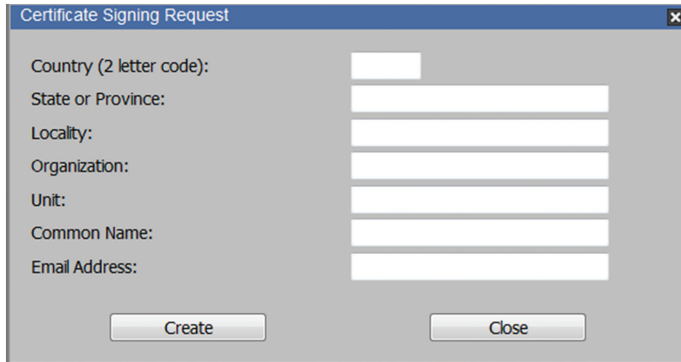

2. Fill in the form with the appropriate information for your company. The table below is an example of a filled out form.

Field	Example
Country (2 letter code)	US
State or Province	IL
Locality	US
Organization	Your Company, Ltd.
Unit	Techdoc Department
Common Name	www.mycompany.com Note: This entry must be the exact domain name of the site that you want the certificate to be valid for. If the site's domain name is www.mycompany.com , and you enter mycompany.com, the certificate will not be valid.
Email Address	administrator@yourcompany.com

3. When all fields have been filled out (all fields are required), click the *Create* button.

4. Click the *Get CSR* button, and then save the certificate file to a convenient location on your computer. This is the file that you give to the third party CA to apply for their signed SSL certificate.

5. After you have received the certificate from the third party CA, save it to a convenient location on your computer. In the *Certificate Signing Request* section of the *Security* page, click the *Browse* button and navigate to and select the certificate.

6. Click the *Upload* button.

Note: When uploading the file, the KVM checks to make sure the specified information still matches. If it does, the file is accepted. If it does not match, the file will be rejected. If you want to remove the certificate (e.g. to replace it with a new one because of a domain name change), click the *Remove CSR* button.

OSD Operation

Date/Time

The *Date/Time* page allows the user to set the date and time parameters for the KVM switch. The following section describes the settings on this page.

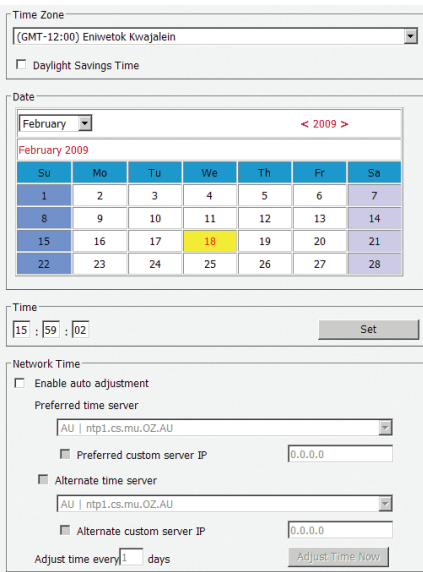

The screenshot shows the Date/Time configuration interface. It is divided into four main sections:

- Time Zone:** A dropdown menu is set to "(GMT-12:00) Eniwetok Kwajalein". There is an unchecked checkbox for "Daylight Savings Time".
- Date:** A calendar for February 2009 is displayed. The 18th is highlighted in yellow.
- Time:** The time is set to 15:59:02. A "Set" button is located to the right.
- Network Time:** This section has an unchecked "Enable auto adjustment" checkbox. It contains two server configuration blocks:
 - Preferred time server:** A dropdown menu is set to "AU | ntp1.cs.mu.OZ.AU". There is an unchecked checkbox for "Preferred custom server IP" with a text field containing "0.0.0.0".
 - Alternate time server:** A dropdown menu is set to "AU | ntp1.cs.mu.OZ.AU". There is an unchecked checkbox for "Alternate custom server IP" with a text field containing "0.0.0.0".At the bottom, there is an "Adjust time every" field set to "1" days and an "Adjust Time Now" button.

Time Zone

- Select the Time Zone and City that most closely resembles where the KVM switch is in using the drop-down menu at the top of this section.
- If your area uses Daylight Savings Time, check the *Daylight Savings Time* checkbox.

To manually set the date and time, do the following:

1. In the *Date* section, select the current month using the drop-down menu.
2. If needed, click the < or > buttons in the *Date* section to move backward or forward to the correct year.
3. In the calendar in the *Date* section, click on the current day.
4. In the *Time* section, enter in the current time using the 24 hour HH:MM:SS format.
5. Click the *Set* button in the *Time* section to apply your changes.

Network Time

To have the time automatically synchronized to a network time server, do the following:

1. Check the *Enable Auto Adjustment* checkbox.
2. Select a time server from the *Preferred Time Server* drop-down list; or, check the *Preferred Custom Server IP* checkbox and enter in the IP of your preferred time server.
3. If desired, repeat step two to enter an *Alternate Time Server*.
4. Key in the desired number of days between synchronization in the *Adjust Time Every __ Days* field.
5. Click the *Adjust Time Now* button to synchronize immediately.

Blade Server Configuration

For Super Administrators and Administrators/Users who have been given permission, when you access the *Device Management* section with a Blade Server selected in the Sidebar tree, its Configuration page appears.

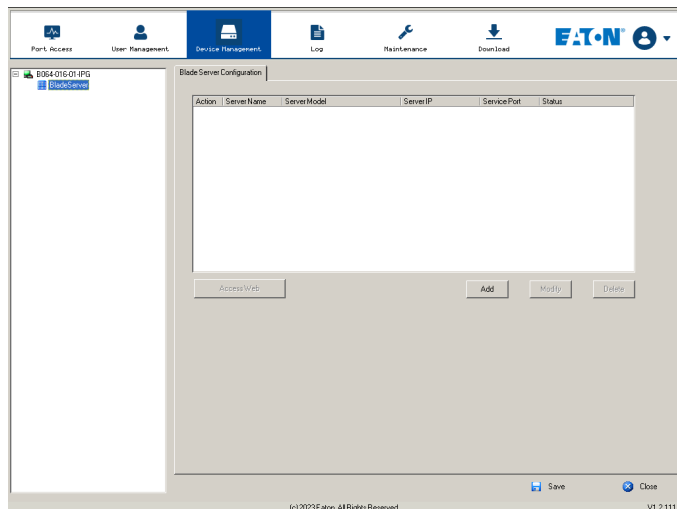

The screenshot shows the Blade Server Configuration page. It features a navigation bar at the top with icons for "Part Access", "User Management", "Device Management", "Log", "Maintenance", and "Download". The main content area has a sidebar on the left with "0044-016-01-4PG" and "BladeServer" selected. The central part of the page contains a table with the following columns: "Action", "Server Name", "Server Model", "Server IP", "Service Port", and "Status". Below the table are buttons for "Access Web", "Add", "Modify", and "Delete". At the bottom of the page, there are "Save" and "Close" buttons, and a copyright notice: "© 2023 Eaton. All Rights Reserved. V1.2.111".

Adding a Blade Server

To configure a new blade server, do the following.

1. Select its icon in the Sidebar tree, then click *Add* in the main panel. The *Setup Blade Server* dialog box appears, with the Step 1 tab displayed.

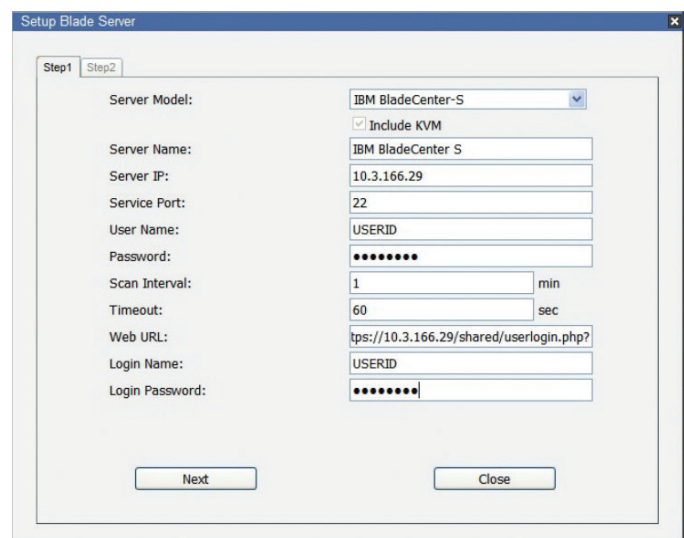

The screenshot shows the "Setup Blade Server" dialog box. It has two tabs: "Step1" and "Step2". The "Step1" tab is active and contains the following fields:

- Server Model:** A dropdown menu set to "IBM BladeCenter-S".
- Include KVM:** A checked checkbox.
- Server Name:** A text field containing "IBM BladeCenter S".
- Server IP:** A text field containing "10.3.166.29".
- Service Port:** A text field containing "22".
- User Name:** A text field containing "USERID".
- Password:** A password field with masked characters "*****".
- Scan Interval:** A text field containing "1" with a "min" unit selector.
- Timeout:** A text field containing "60" with a "sec" unit selector.
- Web URL:** A text field containing "https://10.3.166.29/shared/userlogin.php?".
- Login Name:** A text field containing "USERID".
- Login Password:** A password field with masked characters "*****".

At the bottom of the dialog box, there are "Next" and "Close" buttons.

OSD Operation

Blade Server Configuration

2. Fill in the fields according to the information provided in the following table.

Field	Description
Server Model	Select your blade server model from this drop down list.
Include KVM	This item is for information purposes and can't be edited. If the server supports a KVM function, this box is checked. Otherwise, it is unchecked.
Server Name	Enter in a name for the blade server here.
Server IP	Enter in the IP address (IPv4, IPv6, or domain name) used to access the blade server via a serial connection (Telnet or SSH).
Service Port	Enter the port number used for serial access.
User Name	Enter in the username required for serial access authentication.
Password	Enter in the password required for serial access authentication.
Scan Interval	Enter in the interval that determines how frequently the KVM switch scans the blade server for information.
Timeout	Enter in the amount of time that the KVM switch will wait for a response from the blade server before it stops scanning.
Web URL	Enter in the IP address (IPv4, IPv6, or domain name) used to access the blade server via web browser.
Login Name	Enter in the username required for browser authentication.
Login Password	Enter in the password required for browser authentication.

3. When you have finished configuring the fields, click *Next* to bring up the dialog box with the Step 2 tab displayed.

4. The Step 2 dialog presents a summary of the blade server's configuration, including the number of blades installed. Click *Save* to add the blade server to the installation.

Modifying / Deleting a Blade Server

- To modify a blade server's configuration, first select it in the Sidebar tree, and then click *Modify*. Make your changes on the *Setup Blade Server* dialog box.
- To remove a blade server, first select it in the Sidebar tree, and then click *Delete*.

Web Access

To access the blade server's Web page, first select it in the Sidebar tree, and then click *Access Web*.

Log

The B064-Series KVM switch logs all the events that take place and writes them to a log file. The Log section is split into two sub-sections; *Log Information* and *Notification Settings*.

Log Information

The *Log Information* sub-section is where you can view the contents of the built-in log file. When opened, a page similar to the one below appears.

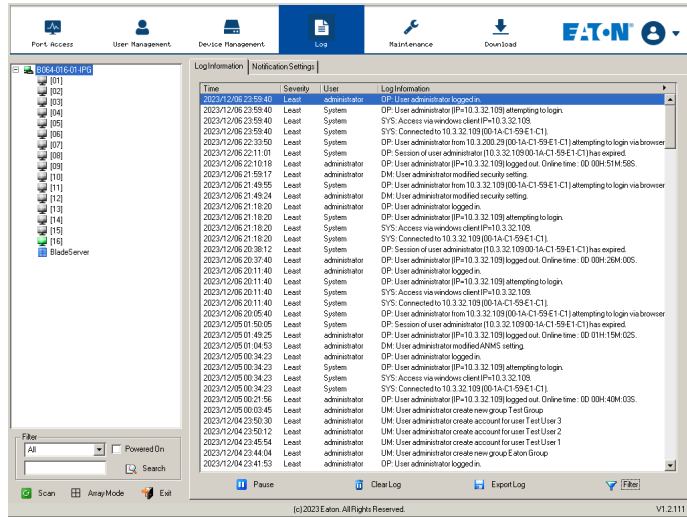

The *Log Information* page can store up to 512 events, at which time the oldest files are deleted and replaced with newer files. The records it displays show the *Time*, *Severity*, *User* and *Log Information* associated with the event. At the bottom of the screen are four icons, whose functionality is described below.

- **Pause** – Clicking the *Pause* button stops new events from being displayed in the *Log Information* page. When clicked, the icon changes to *Resume*. Click *Resume* to allow events to be displayed again.
- **Clear Log** – Clicking the *Clear Log* button will clear the records displayed in the *Log Information* page.
- **Export Log** – Clicking the *Export Log* button will allow you to export and save the log file to your computer.
- **Filter** – Clicking the *Filter* button opens the *Filter* settings, shown below, which allow you to display only records that match the filter settings entered. The filter settings are described in the table below.

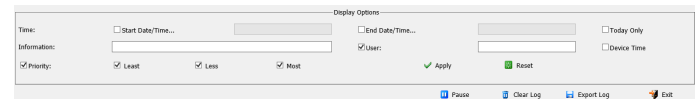

Field	Example
Time	The <i>Time</i> filter settings allow you to display only those records that occurred at a specific time. Below are the options. <ul style="list-style-type: none"> • Today Only – Check the <i>Today Only</i> checkbox and click the <i>Apply</i> button to display only those events that occurred on today's date. • Device Time – Shows the events according to the time configuration on the switch. • Start Date/Time – Check the <i>Start Date/Time</i> checkbox and click in the field to the right of it to bring up a calendar that allows you to select a desired date and time. Click the <i>Apply</i> button to display all of the events that occurred between the date/time entered into the <i>Start Date/Time</i> field and the present date/time. • End Date/Time – This setting works in conjunction with the <i>Start Date/Time</i> field. Check the <i>Start Date/Time</i> checkbox and click in the field to the right of it to bring up a calendar that allows you to select a desired date and time. Check the <i>End Date/Time</i> checkbox and click in the field to the right of it to bring up a calendar that allows you to select a desired date and time. Click the <i>Apply</i> button to display all of the events that occurred between the date/time entered into the <i>Start Date/Time</i> field and the date/time entered into the <i>End Date/Time</i> field.
Information	The <i>Information</i> field allows you to type in a key word or string, and display only those records that contain the search term. Simply type in a search term and click the <i>Apply</i> button.
User	The <i>User</i> field allows you to type in a user name, and display only those records that contain the text that you entered in the <i>User</i> field. To filter by <i>User</i> , you must check the <i>User</i> checkbox, type in a search term, and then click the <i>Apply</i> button.
Priority	The <i>Priority</i> fields allow you to filter by the <i>Priority</i> of the event being recorded; <i>Least</i> , <i>Less</i> or <i>Most</i> . To filter by <i>Priority</i> , check the <i>Priority</i> checkbox, then check the <i>Priority</i> level checkbox(es) that you wish to filter by, and then click the <i>Apply</i> button.
Reset	Click the <i>Reset</i> button at any time to clear any filter settings that were entered and display all events.
Exit	Click the <i>Exit</i> button to close the <i>Filter</i> settings.

Notification Settings

The *Notification Settings* sub-section allows you to select which events are sent out to SNMP, SMTP and SysLog servers. Simply check the checkboxes in the rows of the events that you want notifications sent out for, and in the column(s) of the methods you want them to be sent to. When checked, the corresponding event notification will be sent using the corresponding method.

Note: Notifications default with an "X", which means they are disabled. Click on a notification box to mark it with a check, enabling it. You can check multiple boxes at the same time using the [Shift] or [Ctrl] keys. To highlight a group of consecutive ports, start by highlighting the first port, hold down the [Shift] key, and then highlight the last port that you wish to highlight. All ports from the first one you highlighted to the last will be highlighted. You can then click on any of the permission checkboxes to change that permission for all of the highlighted ports. To highlight multiple non-consecutive ports, start by highlighting the first port, hold down the [Ctrl] key, and then highlight each additional port one by one while continuing to hold down the [Ctrl] key. When all of the desired ports are highlighted, click on any checkbox to change that permission for all of the highlighted ports.

Maintenance

The Maintenance section is used to upgrade the B064-Series KVM Switch's firmware, as well as the firmware of the Server Interface Units (SIUs) used to connect its ports to the installed devices.

Note: Super Administrators are the only users who are guaranteed access to the Maintenance section of the KVM. Administrators and Users can only access this function if they are given permission.

The Main Screen

The *Maintenance* section can be used to upgrade the KVM and SIU firmware, backup/restore system configuration and account information, ping network devices, and restore the KVMs default values. When selected, the *Maintenance* section opens with the *Upgrade Main Firmware* subsection displayed.

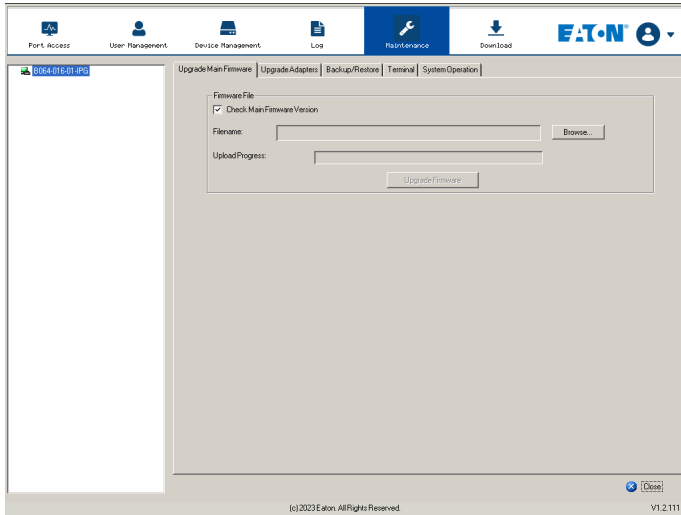

Upgrade Main Firmware

The Upgrade Main Firmware sub-section is used to upgrade the firmware of the KVM switch. As firmware upgrades become available, they can be found on [Tripplite.Eaton.com/support](https://www.tripplite.com/support). To upgrade the KVM firmware, follow the steps below.

1. Go to [Tripplite.Eaton.com/support](https://www.tripplite.com/support) to download the most current firmware and save it to a computer that is not connected to the KVM switch.
2. Logon to the OSD, and navigate to the *Maintenance* section, which will open with the *Upgrade Main Firmware* sub-section page displayed.
3. By default, the *Check Main Firmware Version* box is checked, which causes the KVM to check to see if the current firmware is newer than that of the firmware file you are using to upgrade the KVM. If the current version is newer, you will not be allowed to continue with the upgrade. If you wish to perform a firmware upgrade without checking to see if the current firmware version is newer than the upgrade file, simply uncheck this checkbox.
4. Click the *Browse* button, and then navigate to and select the firmware upgrade file you downloaded from the Eaton website. When selected, the *Upgrade Firmware* button becomes active.
5. Click the *Upgrade Firmware* button to begin the firmware upgrade. As the upgrade proceeds, progress is shown in the *Upload Progress* bar.
6. When the upload is complete, a pop-up appears stating *System will reboot in a few seconds*. The KVM switch will reboot (this may take a few minutes), and the upgrade will be complete. In the event of a firmware upgrade failure, see the *Main Firmware Upgrade Recovery* section below.

Main Firmware Upgrade Recovery

Should the KVM firmware upgrade procedure fail, and the switch becomes unusable, follow the steps below to restore the KVM.

1. Power off the KVM.
2. Press and hold the *Reset* switch on the front of the unit.
3. Power on the KVM while holding down the *Reset* switch.
4. The KVM will be restored to the originally installed firmware version. You will now be able to access the KVM switch and try upgrading the firmware again.

Maintenance

Upgrade Adapters

In addition to upgrading the KVM firmware, the *Maintenance* section allows you to upgrade the firmware of the connected SIUs. The firmware upgrade file for the master KVM also contains the firmware for the SIUs, so you do not need separate files for each SIU. Once you have uploaded the most current KVM firmware, the most current SIU firmware is available via the *Upgrade Adapters* sub-section.

Note: Only those SIUs that are directly connected to the master KVM switch can be upgraded. SIUs that are connected to cascaded KVMs will not be upgradeable via the master KVMs Maintenance section.

To upgrade the firmware to the connected SIUs, follow the steps below.

1. Logon to the OSD, and navigate to the *Maintenance* section, which will open with the *Upgrade Main Firmware* sub-section page displayed. Select the *Upgrade Adapters* sub-section. The *Upgrade Adapters* page opens, with a list of KVM ports displayed, and the model number and firmware version number of the connected SIUs listed to the right of the port number.
2. By default, the *Check Adapter Firmware Version* box is checked, which causes the KVM to check to see if the current firmware is newer than that of the firmware file you are using to upgrade the SIUs. If the current version is newer, you will not be allowed to continue with the upgrade. If you wish to perform a firmware upgrade without checking to see if the current firmware version is newer than the upgrade file, simply uncheck this checkbox.
3. Click the *Adapter Firmware Info* button to display the most current SIU firmware versions available on the KVM switch. Compare this information with the firmware version numbers displayed in the *Upgrade Adapters* list. If the version number displayed next to the connected SIUs is older than that in the *Adapter Firmware Info* list, you should upgrade the firmware.
4. Check the checkbox next to each SIU you wish to upgrade. Check the master KVM checkbox to automatically check all SIUs at once.
5. Click the *Upgrade Adapters* button to begin the firmware upgrade. As the upgrade proceeds, progress is shown in the *Status* column.
6. When the upgrade is finished, the *Status* column will display the text *Upgrade Successful*. In the event of a firmware upgrade failure, see the *SIU Firmware Upgrade Recovery* section below.

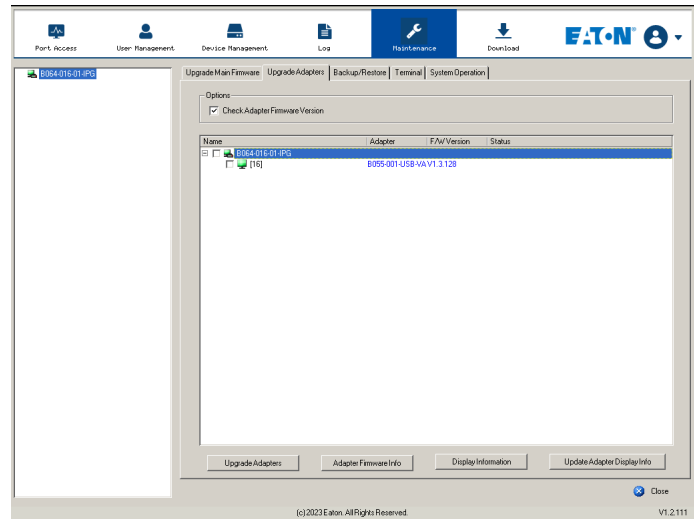

SIU Firmware Upgrade Recovery

Should the SIU firmware upgrade procedure fail, and the SIU becomes unusable, follow the steps below.

1. Unplug the SIU from the computer/server it is connected to.
2. Slide the *Firmware Upgrade Recovery* switch (located next to the Cat5 connector) to the *Recover* position.
3. Plug the SIU back into the computer/server.
4. Start the SIU firmware upgrade procedure again.
5. After the SIU has been successfully upgraded, unplug it from the computer/server, slide the *Firmware Upgrade Recovery* switch to the *Normal* position, and plug it back in.

Maintenance

Backup/Restore

The *Backup/Restore* subsection allows you to backup and restore the KVM switch configuration and user profile information.

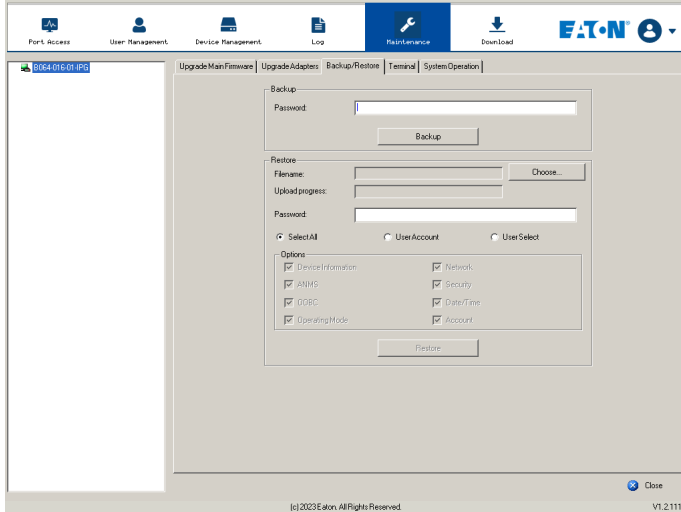

Backup

To create a backup of the KVM switch, follow the steps below.

1. Key in a password in the *Password* field.

Note: *Setting a password is optional. If you do not wish to use a password, you can skip this step.*

2. Click the *Backup* button.
3. A pop-up appears asking you to save the backup file. Browse to a desired location on your computer to save the file to.

Restore

To restore the KVM switch using a backup file, follow the steps below.

1. Click on the *Browse* button to the right of the filename field, and then navigate to and select the backup file.
2. If you set up a password when creating the backup file, enter it in the *Password* field.
3. Select as many of the options that are presented as you wish to restore, and then click the *Restore* button. Once complete, a message appears to inform you that the procedure succeeded.

Terminal

Terminal provides a command line to execute options using a terminal interface. Type a command in the window and hit [Enter] to execute it.

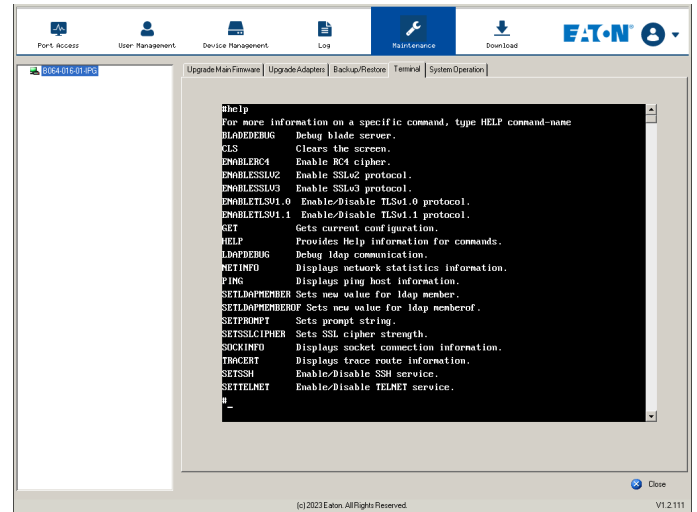

Available commands include:

Note: *The B064-008-01-IPG & B064-016-01-IPG will not have the SETMAXFRAMERATE.*

- BLADEDEBUG => Debug blade server.
- CLS => Clears the screen.
- ENABLERC4 => Enable RC4 cipher.
- ENABLESSLV2 => Enables SSLv2 protocol.
- ENABLESSLV3 => Enables SSLv3 protocol.
- ENABLETLSV1.0 => Enable/Disable TLSv1.0 protocol
- ENABLETLSV1.1 => Enable/Disable TLSv1.1 protocol
- GET => Gets current configuration.
- HELP => Provides Help information for commands.
- LDAPDEBUG => Debugs ldap communication.
- NETINFO => Displays network statistics information.
- PING => Displays ping host information.
- SETLDAPMEMBER => Sets new value for ldap member.
- SETLDAPMEMBEROF => Sets new value for ldap memberof.
- SETPROMPT => Sets prompt string.
- SETSSLCIPHER => Sets SSL cipher strength.
- SOCKINFO => Displays socket connection information.
- TRACERT => Displays trace route information.
- SETSSH => Enable/Disable SSH service.
- SETTELNET => Enable/Disable TELNET service.

OSD Operation

Maintenance

System Operation

The *System Operation* sub-section allows you to clear port names, and reset the KVM configuration settings to their default values.

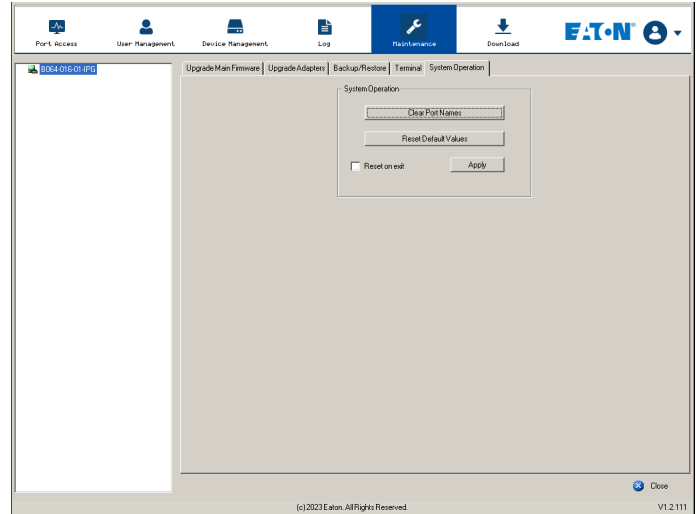

The functions available in the *System Operation* page are explained in the table below.

Field	Example
Clear Port Names	Click this button to clear all of the port names on the installation and restore them to their default values. Upon clicking this button, you will be prompted to confirm that you wish to clear all port names. Click Yes to proceed.
Reset Default Values	Click this button to undo all configuration changes that have been made to the KVM, and restore them to the factory default settings. This does not affect port names, account information or network information. Upon clicking this button, you will be prompted to confirm that you wish to proceed. Click Yes to proceed.
Reset on Exit	Check this box and click the <i>Apply</i> button to have the KVM switch reset itself and implement all new settings upon logging out. (Following the reset, allow approximately 30 to 60 seconds before logging back into the KVM.) If you change the IP address of the KVM, the Reset on Exit checkbox is automatically checked. To prevent the KVM from resetting and saving the new IP address, uncheck this box. Note: <i>Un-selecting this checkbox will only cause the new network settings to be ignored for one logout. When you log back in, the changes you made still appear in the Network settings fields, and the Reset on Exit checkbox is once again checked. To ensure that these settings don't get changed to something you don't want, always make sure that you leave the Network settings page with the correct information entered in.</i>

Download

The Download icon is used to download non-browser AP versions of the Windows and Java Clients, as well as the Log Server. Selecting this tab will open a drop-down list of the programs that are available for download.

Note: *If you have not been given access to one of these applications, you will not be able to download it.*

Click on the Download icon and select the program you want to download. Save it to a convenient location on your hard disk and run it from there.

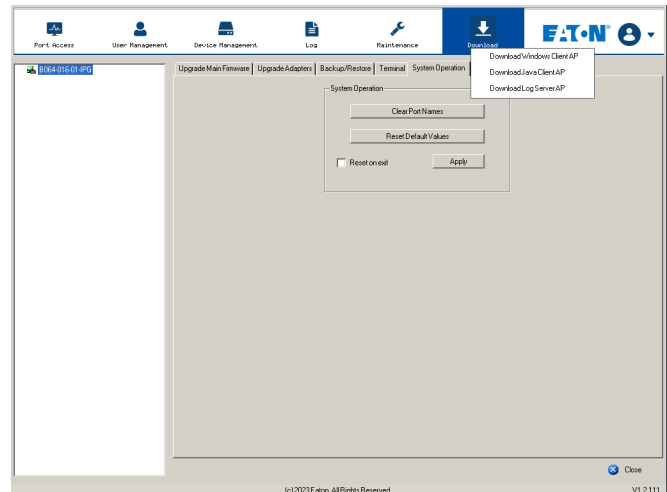

Remote Session Operation

After you have successfully logged in (see *Logging Into the B064-Series KVM Switch* section), the B064-Series KVM Switch OSD Main Page appears with the Port Access tab selected:

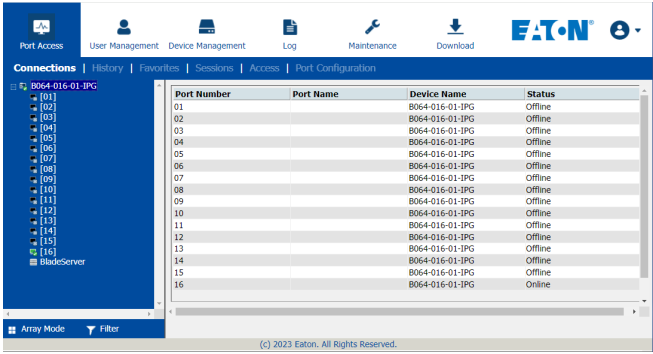

Note: The AP Client and Local Console versions feature a Control Panel in the top center of the screen that appears when scrolled over with the mouse. The web browser version's Control Panel is only available when the port has been accessed. (See Control Panel section for details.)

All the ports that a user is permitted to access are listed in the Port Selection panel at the left of the page. Ports to which users do not have access will not be displayed in their OSD. Double-click a port icon to access the device attached to it. Once you switch to a port, its screen displays on your monitor. Depending on whether you have Full Access or View Only access to the port, you may or may not be able to operate the remote computer using your keyboard and mouse.

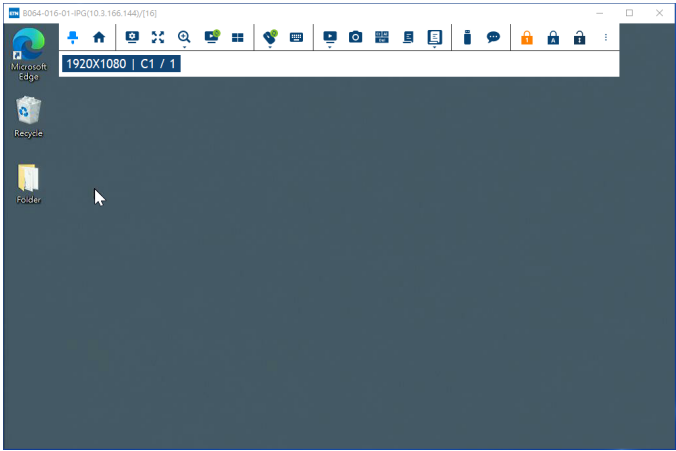

Control Panel

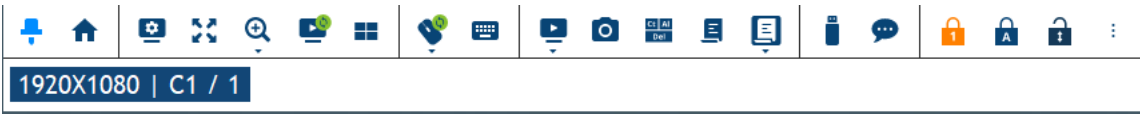

The *Control Panel* is provided as a way for the user to optimize and control the remote session. Regardless of whether you initiated a remote session via the Windows or Java browser and non-browser clients, the control panel and its functionality remain the same. To display the *Control Panel*, hover your mouse pointer over the top-center of the remote screen.

The *Control Panel* consists of an icon bar at the top and two text bars at the bottom. When the mouse pointer is hovered over an icon, the description of the icon is displayed in the text bar. When the mouse pointer is not over an icon, the text bars display the video resolution of the selected computer and the IP address of the KVM switch. You can drag the control panel to any location on the remote screen by hovering over the text bar, and then clicking-and-dragging it. Each of the icons contained in the *Control Panel* and their functionality is explained in the sections that follow.

Always on Top / Auto Hide – Click this button to toggle between displaying the control panel all the time, or to allow it to disappear after a few seconds of inactivity.

Hotkeys / Macros – The *Hotkeys / Macros* page allows the user to use Hotkeys and Macros to manipulate the remote computers. The user can enable/disable hotkeys, and create/edit *User Macros* and *System Macros*. The sections that follow describe how these features work.

Remote Session Operation

Control Panel

Hotkeys

Various configuration actions related to the keyboard, video and mouse can be performed via hotkey combinations. The *Hotkey* setup utility is accessed by clicking on the *Hotkey / Macros* icon and then clicking on the *Hotkeys* button at the top of the screen. The *Hotkeys* screen displays the available hotkeys and their corresponding hotkey combinations.

By default, the only hotkeys that are enabled are the *Exit Remote Location* and *Substitute Alt Key* hotkeys. To enable/disable a hotkey, simply check/uncheck the box to the left of it. To change a hotkey's command sequence, follow the steps below.

1. Highlight the desired hotkey and click on the *Set Hotkey* button.
2. Key in the desired hotkey combination, one key at a time. The keys will be displayed in the hotkey column as they are entered.

Note: Clicking the *Cancel* button will cancel the recording process. Clicking on the *Clear* button will delete any keys that you entered while keeping the recording process active.

3. When finished entering the hotkey sequence, click on the *Save* button.

Note: Clicking the *Reset* button will restore all of the default hotkey command sequences, and enable/disable defaults. You can use the same function keys for more than one hotkey command sequence, as long as the first key is not the same. For example, you can use [F1, F2, F3] for one action and [F2, F1, F3] for another, but you cannot use [F1, F3, F2] once [F1, F2, F3] has been used.

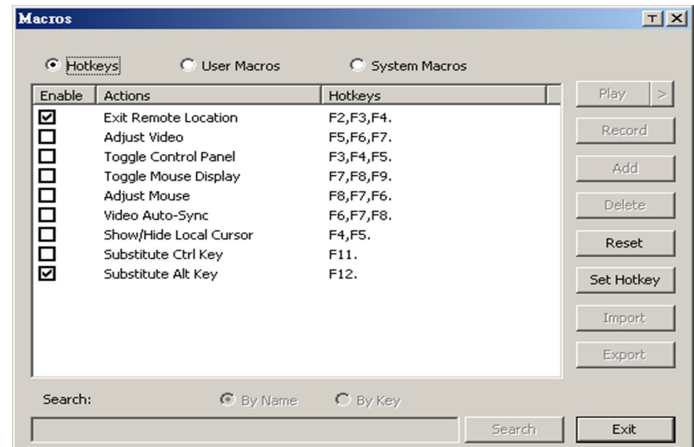

The table below lists the default hotkeys, along with a description of their functions and their default command sequences.

Hotkey	Description	Command Sequence
Exit Remote Location	Closes you out of a remote session.	[F2, F3, F4]
Adjust Video	Opens the <i>Video Settings</i> screen.	[F5, F6, F7]
Toggle Control Panel	Toggles the <i>Control Panel</i> off and on. When off, you will not be able to access the control panel.	[F3, F4, F5]
Toggle Mouse Display	Toggles the local mouse pointer between an arrow and a tiny circle. Note: This Hotkey appears when accessing the WIN Client only.	[F7, F8, F9]
Adjust Mouse	When the local and remote mouse pointers go out of sync, this command brings them back together again.	[F8, F7, F6]
Video Auto-Sync	Performs a video auto-sync.	[F6, F7, F8]
Show/Hide Local Cursor	Toggles the local mouse pointer on/off.	[F4, F5]
Substitute Ctrl Key	By default, hotkey combinations that use the Ctrl key, such as [Ctrl, Alt, Delete], get sent to the local computer. This hotkey allows you to set a substitute Ctrl key that can be used for the remote computer.	F11
Substitute Alt Key	By default, hotkey combinations that use the Alt key, such as [Ctrl, Alt, Delete], get sent to the local computer. This hotkey allows you to set a substitute Alt key that can be used for the remote computer.	F12

Remote Session Operation

Control Panel

User Macros

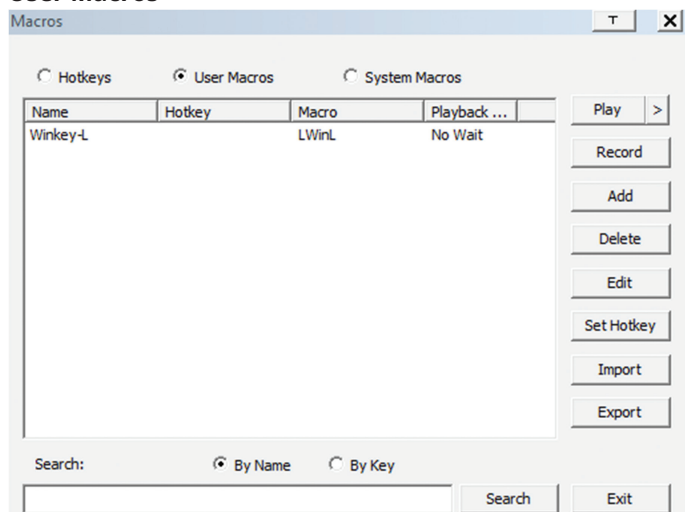

The *User Macros* page allows you to add macros to the KVM switch that can be performed on any of the connected computers using the *Macro List* feature of the control panel. (See *Macro List* section under *Control Panel* in *Remote Session Operation* for details.) By default, the *User Macros* page is displayed when the *Hotkeys / Macros* icon is clicked on. To display the page when it isn't selected, click on the *User Macros* button at the top of the *Hotkeys / Macros* screen.

To create a macro, follow the steps below.

1. Click the *Add* button on the right side of the screen.
2. In the name field that appears, key in a name for the macro you are adding.
3. With the new macro highlighted, click the *Record* button on the right side of the screen. Recording will begin and the following panel will be displayed in the upper-left corner of the remote screen.

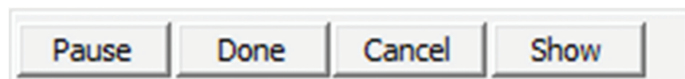

4. Enter in the macro hotkey sequence and then click the *Done* button. You will be returned to the *User Macros* screen, with your macro name and hotkey combination added to the list. Repeat this procedure for any additional macros you wish to create.

Note: Clicking the *Pause* button will pause/unpause the recording of the hotkey sequence. Clicking the *Cancel* button will cancel the recording of the hotkey sequence. Clicking the *Show* button will display the hotkeys as they are entered.

System Macros

The *System Macros* page allows you to add macros to the KVM switch that can be performed automatically upon closing a session. For example, you can create a macro that sends the Winkey-L combination, causing a computer's login page to come up the next time it is accessed. To display the *System Macros* page when it isn't selected, click on the *System Macros* button at the top of the *Hotkeys / Macros* screen.

To create a macro, follow the steps below.

1. Click the *Add* button on the right side of the screen.
2. In the name field that appears, key in a name for the macro you are adding.
3. With the new macro highlighted, click the *Record* button on the right side of the screen. Recording will begin and the following panel will be displayed in the upper-left corner of the remote screen.



4. Enter in the macro hotkey sequence and then click the *Done* button. You will be returned to the *System Macros* screen, with your macro name and hotkey combination added to the list. Repeat this procedure for any additional macros you wish to create.

Note: Clicking the *Pause* button will pause/unpause the recording of the hotkey sequence. Clicking the *Cancel* button will cancel the recording of the hotkey sequence. Clicking the *Show* button will display the hotkeys as they are entered.

Once system macros are created, they are available to be assigned to ports, with only one macro allowed per port. (See the *Port Configuration* section under *OSD Operation* for details on assigning system macros.)

Remote Session Operation

Control Panel



Video Settings – The *Video Settings* screen allows you to adjust the placement and picture quality of the remote screen. The quality of the image display has a direct affect on the keyboard and mouse response time. Higher quality video results in more information being transferred over the network, which can cause slow keyboard and mouse response time in slower networks. Click this icon to open the *Video Settings* screen.

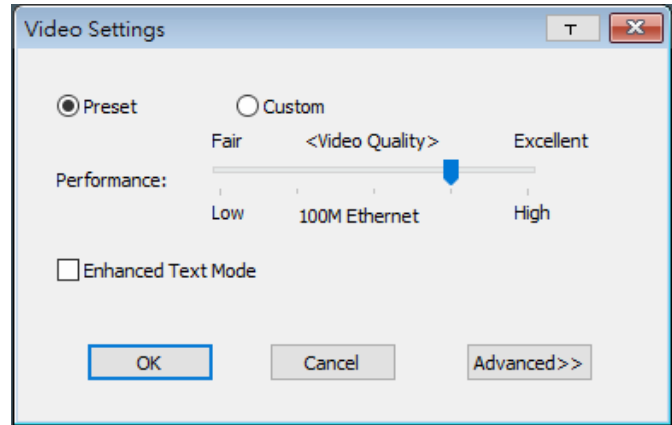

Advanced Video Settings - Clicking the Advanced button will open advanced video settings. The table below describes the advanced video settings contents:

Setting	Description
Preset / Custom	Using the preset and custom buttons allow you to set and save custom video settings and revert back to default video settings.
Performance	Use the slide bar to select the type of Internet connection that the local client computer uses. The switch will use that selection to automatically adjust the video quality settings to optimize the quality of the video display. Since network conditions vary, if none of the preset choices work to your liking, select Advanced and use the video quality slider bar to adjust the settings.
Video Quality	Drag the slider bar to adjust the video quality. The larger the value, the clearer the picture and the more video data goes through the network. Depending on the network bandwidth, a high value may adversely effect response time.
Enable Refresh	The KVM over IP switch can redraw the screen every 1 to 99 seconds, eliminating unwanted artifacts from the screen. Select Enable Refresh and enter a number from 1 through 99. The KVM over IP switch will redraw the screen at the interval you specify. This feature is disabled by default. Click to put a check mark in the box next to Enable Refresh to enable this feature. Notes: <ul style="list-style-type: none"> • The switch starts counting the time interval when mouse movement stops. • Enabling this feature increases the volume of video data transmitted over the network. The lower the number specified, the more often the video data is transmitted. Setting a value too low may adversely affect overall operating responsiveness.
Transparency	Adjusts the transparency of the toolbar that appears when the GUI hotkey ([Scroll Lock] [Scroll Lock], for example) is invoked. Slide the bar until the display in the example window is to your liking.
Color Depth Control	This setting determines the richness of the video display by adjusting the amount of color information.

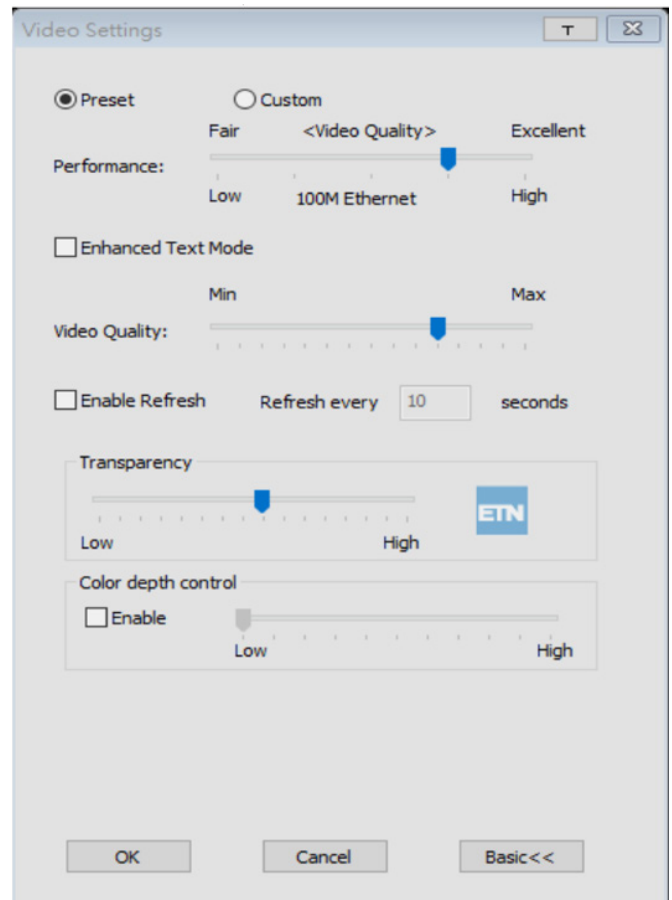

Remote Session Operation

Control Panel



Video Auto Sync – Click this icon to have the vertical and horizontal offset values of the remote screen automatically detected and synchronized with the local screen.

Note: *If the local and remote mouse pointers are out of sync, performing a video auto sync will normally bring them back into alignment. If the video auto sync fails to align the screen properly, use the screen position arrows in the Video Settings screen to make manual adjustments.*



Screen Mode – Click this icon to toggle *Full Screen* mode on/off. For those accessing the KVM via one of the Windows clients, right-clicking this icon will toggle *Keep Screen Size* on/off. When *Keep Screen Size* is enabled, turning on *Full Screen* mode will not change the size of the remote screen. For example, remote screens that are set to resolutions lower than that of the local monitor will be displayed as a box inside of the local display. When both *Keep Screen Size* and *Full Screen Mode* are enabled, the remote screen will be displayed as a box with a black background. If *Keep Screen Size* is disabled and *Full Screen Mode* is enabled, the screen will be stretched to fit the entire local monitor.

Note: *Keep Screen Size can only be toggled on/off when using one of the Windows clients. When using one of the Java clients, Keep Screen Size is always enabled.*



Snapshot – Clicking this icon will take a screenshot of the remote computer and save it to the local computer. By default, snapshots are saved to the local computer's desktop. The file type, quality and location can be changed via the *Customize Control Panel* page.



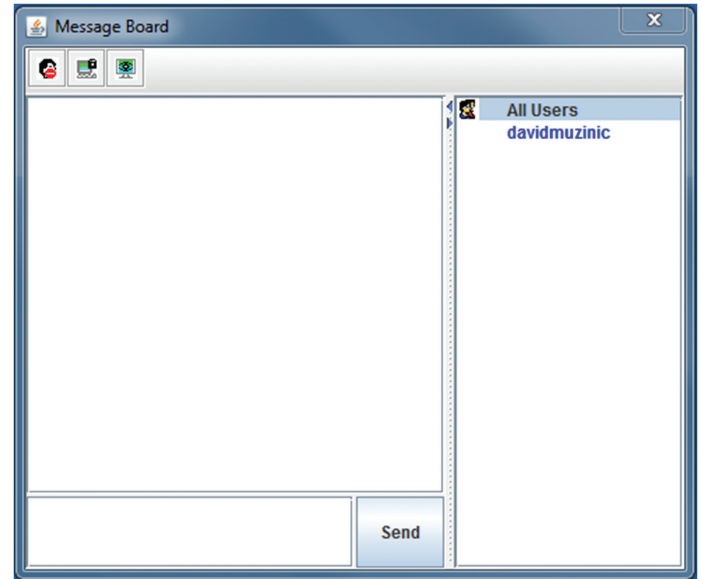

Message Board – The B064-Series KVM supports multiple user logins, which can give rise to access conflicts. To alleviate this problem, a message board feature has been provided that allows users to communicate with each other.



Remote Session Operation

Control Panel

The buttons on the button bar at the top of the message board are toggles. The actions for each of these buttons are described in the table below.

Button	Function
	Enable/Disable Chat – When disabled, this icon displays next to the disabled user's name in the <i>User List</i> panel of all users' message boards. Messages directed to the disabled user are not displayed on the message board. The button is shadowed when chat is disabled.
	Occupy/Release Keyboard/Video/Mouse – When you occupy the KVM, other users cannot see the video, and cannot input keyboard or mouse data. A prompt will come up on the locked out users' monitor stating which user has occupied the KVM. The button in the message board is shadowed and this icon displays next to the occupying user's name in the <i>User List</i> of all users' message boards.
	Occupy/Release Keyboard/Mouse – When you occupy the KVM, other users can see the video, but cannot input keyboard or mouse data. The button is shadowed and this icon displays next to the occupying user's name in the <i>User List</i> of all users' message boards.

User List Panel

- To hide/unhide the *User List* panel, click on the arrows in the panel separator.
- The names of all the logged in users appear in the *User List* panel. Select the names of the users that you wish to communicate with before sending your message.
- If a user has disabled chat, its icon displays before that user's name.
- If a user has occupied the KVM or the KM, the corresponding icon displays before that user's name.

Compose Panel

Type your message into this panel and then click the Send button or press the [Enter] key to post the message to the message board.

Note: You must select the user that you want to communicate with from the user list. To send a message to all users, simply click All Users in the user list.

Message Display Panel

Messages that users post to the board, as well as system messages, display in this panel. If you disable chat, messages that get posted do not appear.



Ctrl – Alt – Delete – Click this icon to send the [Ctrl, Alt, Delete] command to the remote computer.



Set to Grayscale – Click this icon to display the remote video in black and white. On slower networks, displaying the remote video in black and white can help improve keyboard and mouse response time.



Virtual Media – The *Virtual Media* function allows a drive, folder, image file or removable disk on a user's system to be accessible on the remote server. The following media are supported via the KVMs *Virtual Media* functionality.

Browser and non-Browser Windows Client

- IDE CD-ROM/DVD-ROM Drives – Read Only
- IDE Hard Drives – Read Only
- USB CD-ROM/DVD-ROM Drives – Read Only
- USB Hard Drives – Read/Write*
- USB Flash Drives – Read/Write*
- USB Floppy Drives – Read/Write
- USB Card Readers
- USB Fingerprint Readers
- ISO Files – Read Only
- Folders – Read/Write

* These drives can be mounted either as a Drive or as a Removable Disk. Mounting as a Removable Disk allows the user to boot the remote server if the disk contains a bootable OS. If the disk contains more than one partition, the remote server can access all of the partitions.

Browser and non-Browser Java Client

- ISO Files – Read Only
- Folders – Read/Write

USB Ports on Front Panel of KVM Switch

- IDE CD-ROM/DVD-ROM Drives – Read Only
- IDE Hard Drives – Read Only
- USB CD-ROM/DVD-ROM Drives – Read Only
- USB Hard Drives – Read/Write*
- USB Flash Drives – Read/Write*
- USB Floppy Drives – Read/Write
- USB Card Readers
- USB Fingerprint Readers

* These drives can be mounted either as a Drive or as a Removable Disk. Mounting as a Removable Disk allows the user to boot the remote server if the disk contains a bootable OS. If the disk contains more than one partition, the remote server can access all of the partitions.

Note: The *Virtual Media* function is only active for computer/servers that are connected to the KVM switch using a B055-001-USB-V2 SIU. Computers connected to a cascaded B064-016 KVM will not be able to use virtual media.

Remote Session Operation

Control Panel

Virtual Media

Virtual Media via Remote Session

When accessing a connected computer remotely, you can use media from the computer you are accessing the KVM switch with on the remote computer. You are also able to access media connected to the USB ports on the front of the KVM switch; however, media connected to these ports needs to be mounted via the local console. (See *Virtual Media via Local Console* section under *Control Panel* in *Remote Session Operation* for details.) To access virtual media via remote session, follow the instructions below.

Note: When accessing the KVM remotely with a Windows Vista or 7 computer, you must run Internet Explorer as an administrator for virtual media to function properly.

1. Click the *Virtual Media* icon on the control panel to bring up the following screen.

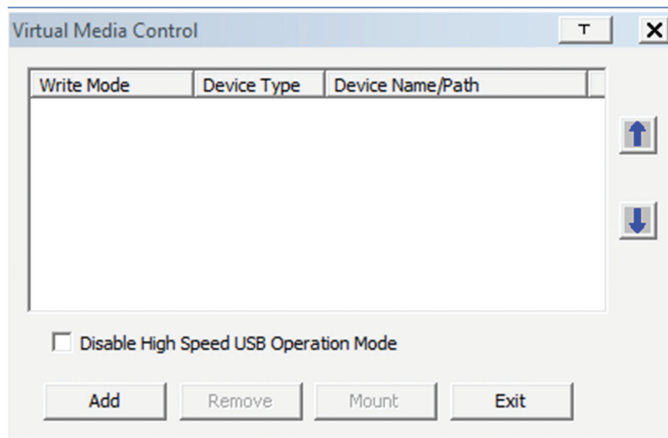

Note: The T button in the upper-right corner brings up a slider bar that allows you to adjust the transparency of the virtual media screen. When you're finished making an adjustment, simply click anywhere on the screen to close the slider bar.

2. Click the *Add* button and then select the desired media from the list of media sources that appears. Each selected media source will allow you to choose the available drive, file, folder or removable disk.

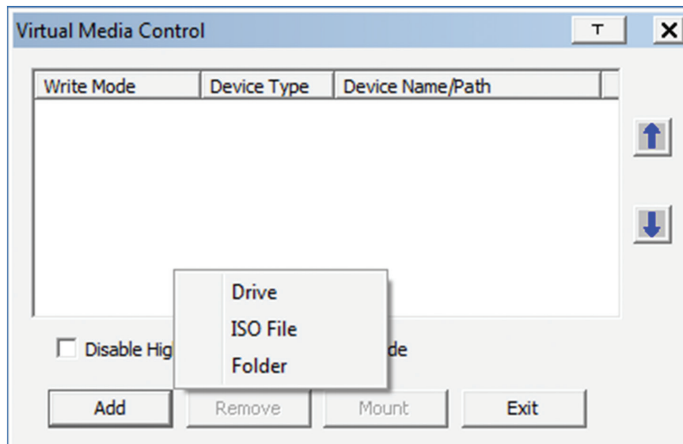

Note: If your media source is USB 1.1, check the *Disable High Speed USB Operation Mode* checkbox.

3. Repeat this step to add as many media sources as you want to the *Virtual Media* screen. To remove a media source from the list, highlight it and click the *Remove* button.

Note: Only 3 media sources can be used at any one time, with the top 3 sources in the list being the active devices. To rearrange the device order, highlight the desired device and use the arrow keys on the right of the screen to move the device up or down in the list.

4. Some media sources are *Read Only*, whereas others are *Read/Write*. Those that are *Read/Write* can be viewed on the remote computer, and can have data from the remote computer added to them. Those that are *Read Only* can only be viewed. *Read Only* media sources will be grayed out in the list, not allowing you to check the *Enable Write* checkbox to the left of the source. *Read/Write* sources will not be grayed out, and you will be able to decide whether data can be added to them or not. By default, *Read/Write* sources are displayed with the *Enable Write* checkbox unchecked, which means that data cannot be added to them. To allow data from the remote computer to be added to a media source, simply check the *Enable Write* checkbox to the left of it in the list.

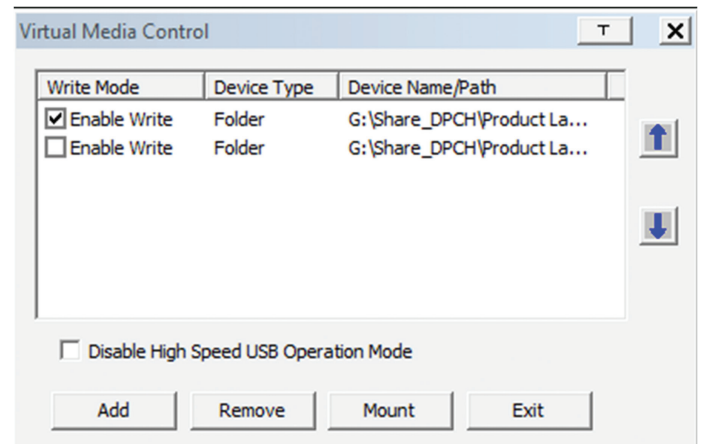

5. Once all media sources are added, and the desired 3 media sources are at the top of the list, click the *Mount* button to close the dialog box and open the media sources on the remote computer.

Note: Depending on the speed of your network and the size of the media source, it may take 30 seconds or so for the dialog box to close and the media to open on the remote computer.

6. To disconnect the media sources from the remote computer, click on the *Virtual Media* icon in the control panel.

Remote Session Operation

Control Panel

Virtual Media via Local Console

When accessing the KVM via the local console, you can mount media connected to the additional USB ports on the front of the KVM, and access it on the connected computers. After connecting a USB device to one of the USB ports on the front of the KVM, follow the instructions below to mount it to a KVM port and access it via the connected computer.

1. Open the OSD and highlight the desired port in the side bar. Right-click on it and select the *Mount* option.
2. A *Virtual Media Settings* box appears, which is exactly the same as the one found when mounting virtual media remotely, except that it contains a *Keep Alive* check box. To add a device, click on the *Add* button to display the list of devices connected to the KVMs front panel, and select the desired device. If your device is USB 1.1, check the *Disable High Speed USB Operation Mode* checkbox. To keep the device mounted even after the local user logs out, check the *Keep Alive* checkbox.
3. Once mounted, the media device will be accessible both locally and remotely. To unmount the device, right-click on the desired port in the OSD and select the *Unmount* option.

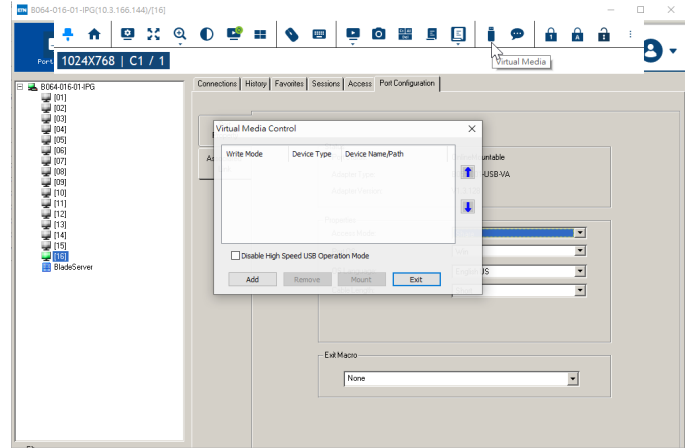

 **Zoom** – Click this icon to zoom in on the remote display. You can choose to display the screen at 100%, 75%, 50% or 25%. Checking the 1:1 checkbox will keep the screen contents sized in a 1:1 ratio, regardless of whether you choose to display the remote session at 100%, 75%, 50% or 25%.

 **On-Screen Keyboard** – The B064-Series KVM switch features an on-screen keyboard, available in multiple languages, with all of the standard keyboard keys for each language. Click this icon to display the on-screen keyboard.



- To switch to a different language keyboard, open the drop-down list in the upper-right of the on-screen keyboard and select the desired language.
- To expand the keyboard to include the number pad, click on the arrow icon to the right of the language drop-down menu.



 **Mouse Pointer** – Click to choose how the local and remote mouse pointers are displayed. You can choose to display *Dual* mouse pointers, *Crosshairs* mouse pointers, the local mouse pointer as a tiny dot (not available via Java), or only the remote mouse pointer. *Dual* mouse pointers display both local and remote mice as arrows. *Crosshairs* mouse pointers display the local mouse as a cross, and the remote mouse pointer as an arrow. When displaying the local mouse pointer as a tiny dot, the remote mouse pointer will be displayed as an arrow.

 **Mouse Sync Mode** – Click to toggle between automatic and manual mouse sync modes. When set to automatic, a green checkmark appears on the icon. When set to manual, a red x appears on the icon.

Note: This icon is only active on computers that are connected to the KVM using a USB SIU. The auto sync functionality only supports Windows and Mac (G4 and higher), and the adapter attribute OS setting must be set to Windows or Mac. (See Port Property section under Port Configuration in OSD Operation for details on the adapter attribute OS setting.)

Mac and Linux Considerations

A second Mac auto sync setting is available for Mac OS X 10.4.11 and higher. If you find that enabling automatic mouse sync per the instructions above does not provide satisfactory results, right-click the mouse in the black text area of the control panel, highlight the Mouse Sync Mode option and select Automatic for MAC 2.

Although Linux does not support automatic mouse sync mode, there is an additional setting in the Mouse Sync Mode drop-down menu for Redhat AS3.0 systems. If you are having difficulty synchronizing the local and remote mice, try right-clicking the mouse in the black text area of the control panel, highlight the Mouse Sync Mode option and select Automatic for Redhat AS3.0.

Remote Session Operation

Control Panel

Manual Mouse Synchronization

If the local mouse pointer goes out of sync with the remote system's mouse pointer, there are a number of methods to bring them back into sync.

Before trying any mouse synchronization procedures, it is always a good idea to ensure that you go to your *Mouse Properties Settings* and set them according to the instructions that follow. The *Mouse Properties Settings* should be set on the computers attached to the B064-Series KVM Switch, not the computer you are using to access it.

Note: *In order for the local and remote mice to synchronize, you must use the generic mouse driver supplied with the MS operating system. If you have a third party driver installed - such as one supplied by the mouse manufacturer - you must remove it.*

Windows 2000:

1. Open the *Mouse Properties* dialog box
2. Click the *Motion* tab
3. Set the mouse speed to the middle position (6 units in from the left)
4. Set the mouse acceleration to *None*

Windows XP and later:

1. Open the *Mouse Properties* dialog box
2. Click the *Pointer Options* tab
3. Set the mouse speed to the middle position (6 units in from the left)
4. Disable *Enhance Pointer Precision*

Sun / Linux:

Open a terminal session and issue the following command:

Sun: `xset m 1`

Linux: `xset m 0`

Mouse Synchronization Procedures

If you are having syncing problems after adjusting the mouse properties, try the following methods to help synchronize the local and remote mouse pointers.

Note: *Mouse synchronization may require several seconds to take effect. Wait for 15 to 30 seconds to ensure that the mouse has had enough time to sync.*

- When in a remote session, move the mouse pointer to the upper-center of the screen to open the control panel, and then move it back into the remote screen. The mouse pointers should align.
- Click the *Video Auto Sync* icon in the control panel. In most cases, the local and remote mouse pointers will sync following the video auto sync.
- Invoke the *Adjust Mouse* hotkey command (see *Hotkeys* section under *Control Panel* for details). This hotkey command defaults at F8, F7, F6.
- Adjust the video settings to decrease the amount of information being transferred over the network. The less data that is being sent, the faster the response time. In particular, the *Quality* and *Detect Tolerance* settings in the *Video Settings* screen (see *Video Settings* section under *Control Panel* for details) can help improve keyboard and mouse response time.
- Go to the *Network* page in the OSD and reduce the *Network Transfer Rate* setting. (See *Network* section under *Device Management in OSD Operation* for details.)
- Go to the display settings section of the remote computer and lower the video resolution, refresh rate and color settings.
- If the remote computer has a graphic desktop background, change it to a solid color background.

Remote Session Operation

Control Panel

 **Speaker** – Click to toggle sound On and Off from the remote server to be heard on the client computer's speakers.

 **Macro List** – Click this icon to display a drop-down list of the User Macros (see *User Macros* section under *Control Panel* for details) that have been added to the KVM switch. Select a macro to run it on the selected computer.

 **Scan Ports** – Click to initiate Auto Scan mode. (See *Auto Scanning* section for details.)

 **Array Mode** – Click to initiate Panel Array mode. (See *Panel Array Mode* section under *The OSD Toolbar* for details.)

 **Open GUI** – Click to open the OSD.

 **Customize Control Panel** – Click this icon to bring up the Customize Control Panel screen, which allows you to choose which icons are displayed in the control panel, as well as edit some of its features.

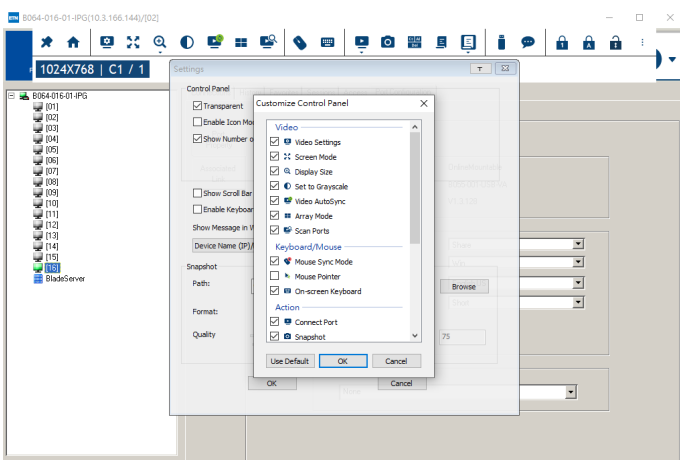

Customize Control Panel – The box on the left side of the screen displays a list of the available control panel features, with a checkbox next to each one. Check/uncheck a checkbox to display or remove the corresponding features icon from the control panel. By default, all features are included in the control panel.

Control Panel Style – This section allows you to determine how the control panel is displayed when it is dragged out of the default position in the top-center of the screen.

Note: *There is a second default position for the control panel at the bottom-center of the screen.*

- When the *Transparent* checkbox is checked, dragging the control panel away from one of the default locations will leave it displayed transparently in whatever location it was dragged to.
- When the *Icon* checkbox is checked, dragging the control panel away from one of the default locations will leave it displayed as an icon in whatever location it was dragged to.
- When both the *Transparent* and *Icon* checkboxes are checked, dragging the control panel away from one of the default locations will leave it displayed as a transparent icon in whatever location it was dragged to.
- When neither checkbox is checked, dragging the control panel away from one of the default locations will leave it displayed as normal in whatever location it was dragged to.
- If the control panel is located in either the top-center or bottom-center default locations, checking these checkboxes will have no effect.

Remote Session Operation

Control Panel

Screen Mode – This section allows you to make *Full Screen Mode* and *Keep Screen Size* the default settings when a remote session is activated.

Note: *Keep Screen Size* is not available when using the Java clients.

- Check the *Full Screen Mode* checkbox to display the remote screen in *Full Screen Mode* starting with the next time you login to a remote session.
- Check the *Keep Screen Size* checkbox to enable the *Keep Screen Size* feature starting with the next time you login to a remote session.

Snapshot – The *Snapshot* section allows you to determine where snapshots are sent to, what file type they are saved as; and, if saved as a JPEG, the quality of the JPEG image. Although the Snapshot section is available to both Windows and Java users, the two differ in the types of files that can be saved. The Windows clients allow you to choose between a BMP and a JPEG file, whereas the Java clients allow you to choose between PNG and JPEG.

- **Path** – To select a location for snapshots to be saved in, click on the *Browse* button next to the *Path* field. Navigate to the desired location and select it.
- **Format** – Check the button of the file type that you want the snapshot to be saved in.
- **JPEG Quality** – If you select to save snapshots as JPEGs, you can adjust the quality of the JPEG image here. The higher the quality of the image, the larger the file size.



Exit – Click this icon to exit the remote session.



Lock LEDs – These icons display the status of the keyboard Num Lock, Caps Lock and Scroll Lock LEDs. You can click on them to toggle the corresponding lock function on/off. When first initiating a remote session, you may have to toggle these off/on to make sure they are synced up with your keyboard.

Remote Session Operation

The OSD Toolbar

The OSD provides a toolbar to help you control the B064-Series KVM Switch from within the captured port. There are three hotkey combinations that can be used to pull up the OSD Toolbar and/or OSD when in a remote session:

- When in a remote session, hit the hotkey **[Scroll Lock]** twice to open the OSD Toolbar.
- When in a remote session, hit the hotkey **[Scroll Lock]** three times to open the OSD.
- When the OSD Toolbar is opened in a remote session, hit the hotkey **[Scroll Lock]** once to open the OSD.

The OSD Toolbar is shown below:



Depending on the settings that were selected for ID Display, the Port Number and/or the Port Name display at the right of the toolbar.

Note: When the toolbar displays, mouse input is confined to the toolbar area and keyboard input (other than the Scroll Lock/Control hotkey) has no effect.

The meanings of the toolbar icons are given in the table below:

Icon	Description
	Click to skip to the first accessible port on the entire installation without having to invoke the OSD.
	Click to skip to the first accessible port previous to the current one without having to invoke the OSD.
	Click to begin Auto Scan Mode. The B064-Series KVM Switch automatically switches among the ports that were selected for Auto Scanning in the Port Select and Filter functions. This allows you to monitor their activity without having to switch among them manually.
	Click to skip from the current port to the next accessible one without having to invoke the OSD.
	Click to skip from the current port to the last accessible port on the installation without having to invoke the OSD.
	Click to bring up the OSD.
	Click to close the OSD toolbar.
	Click to invoke Panel Array Mode. (See <i>Panel Array Mode</i> section under <i>The OSD Toolbar</i> for details.)
	As the length of Cat5 cable between the KVM and connected computer can affect video quality, this setting is designed to compensate for shorter or longer lengths. Click to toggle through the Cat5 cable length options; <i>Short (Less than 32 ft. / 10 m)</i> , <i>Medium (Between 32 ft. / 10 m and 82 ft. / 25 m)</i> and <i>Long (Over 82 ft. / 25 m)</i> .

Toolbar Hotkeys

When the *Toolbar* is displayed, hotkeys can be used to switch between ports. The table below describes what actions can be performed.

Hotkey	Action
←	Skips from the current port to the first accessible port previous to it. To gain control of the selected port, hit the [Esc] key or click on the X icon in the <i>Toolbar</i>
→	Skips from the current port to the first accessible port after it. To gain control of the selected port, hit the [Esc] key or click on the X icon in the <i>Toolbar</i>
↑	Skips from the current port to the first accessible port on the installation. To gain control of the selected port, hit the [Esc] key or click on the X icon in the <i>Toolbar</i>
↓	Skips from the current port to the last accessible port on the installation. To gain control of the selected port, hit the [Esc] key or click on the X icon in the <i>Toolbar</i>
A	Starts an <i>Auto Scan</i> . To exit <i>Auto Scan</i> and take control of the currently selected port, hit the [Esc] or [Spacebar] key, or click on the X icon in the <i>Toolbar</i> .
P	Pauses an <i>Auto Scan</i> . To resume scanning, hit any key other than the [Esc] or [Spacebar]

Remote Session Operation

The OSD Toolbar

Panel Array Mode

Clicking the Panel Array icon on the OSD Toolbar or Control Panel invokes Panel Array Mode. Under this mode, the OSD divides your screen into a grid of panels:

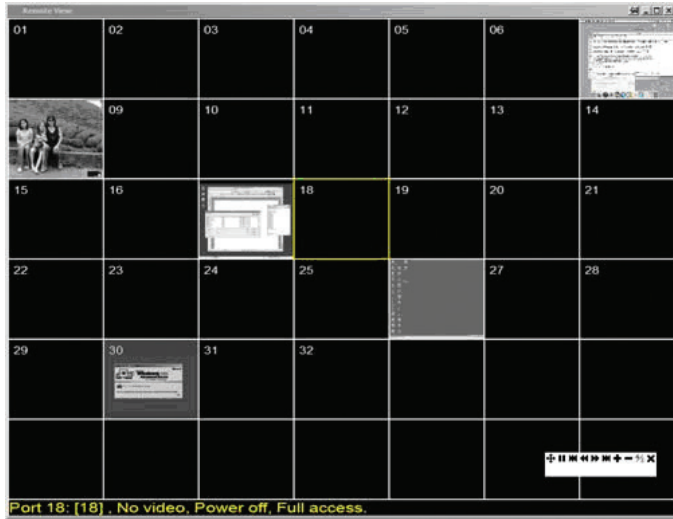

- Each panel represents one B064-Series KVM Switch's ports, beginning with Port 1 at the upper left and continuing from left to right and top to bottom.
- When the Array is first invoked, it scans through each of the ports that were selected for Auto Scanning in the Port Select and Filter functions, and displays information about the port (port name, resolution, online status, port access status), at the bottom of the panel.

Note: The Panel Array scans at one-second intervals. The scan interval is not user definable.

- The number of panels in the array can be increased or decreased by clicking the *Show More Ports* or *Show Fewer Ports* icons on the panel array toolbar.
- If the computer connected to a port is on line, its screen displays in the panel. If not, the panel remains blank.
- Only ports that are accessible to the currently logged in user are displayed. For ports that are not accessible, the panel is blank.
- If you move the mouse pointer over a panel, information about the port displays at the bottom of the panel.
- You can access a computer/server connected to a port by moving the mouse pointer over its panel and double-clicking. This will switch you to the computer exactly as if you had selected it from the OSD Main screen.

Panel Array Toolbar

The Panel Array Toolbar provides shortcut navigation and control of the panel array. The icons in the Panel Array Toolbar are described below:

Icon	Description
	Click this icon to keep the Panel Array Toolbar visible at all times. Click it again to make the toolbar disappear after a few seconds.
	Click and drag any part of the toolbar that is not an icon to move the toolbar to another position on the screen.
	Pause panel scanning, leaving the focus on the currently selected panel.
	Click to move the focus of the Panel Array scan back four panels.
	Click to move the focus of the Panel Array scan to the previous panel.
	Click to move the focus of the Panel Array scan to the next panel.
	Click to move the focus of the Panel Array scan ahead four panels.
	Increase the number of panels in the array.
	Decrease the number of panels in the array.
	Toggle 4/3 aspect ratio.
	Exit Panel Array mode.

Remote Session Operation

Multiuser Operation

B064-Series KVM Switches are designed to allow multiple users to access connected computers/servers simultaneously.

Operation	Rules for Multi-Users on the Same Bus
Auto Scan Mode	When <i>Auto Scan</i> mode is started, all users on that bus will go into <i>Auto Scan</i> mode. If a user on the same bus is in the OSD, they will not go into Auto Scan mode until they access one of the ports. <i>Auto Scan</i> mode can be stopped by any user by opening the OSD. When this occurs, all other users on the bus are switched to the port that last held the KVM's focus during Auto Scan mode.
Panel Array Mode	<ul style="list-style-type: none">• When <i>Panel Array</i> mode is invoked, all users on that bus will go into <i>Panel Array</i> mode. If a user on the same bus is in the OSD, they will not go into <i>Panel Array</i> mode until they access one of the ports. <i>Panel Array</i> mode can only be overridden by <i>Super Administrators</i> and <i>Administrators</i>.• Only the user who starts <i>Panel Array</i> mode can use the skip icons in the <i>Panel Array Toolbar</i>• Only the user who starts <i>Panel Array</i> mode can switch ports. When switching to another port, all users on the bus are switched to the same port. If a user does not have access to the port, they will be unable to view it.• Individual users can increase/decrease the number of panels they can see in <i>Panel Array</i> mode; however, the picture quality may get worse as the number of panels is decreased. For this reason, it is recommended that the user who starts Panel Array mode set it to display at least four panels.

Auto Scanning

The Auto Scan function automatically switches among all accessible ports at regular intervals, so that the user can monitor their activity without having to manually switch between ports. The ports that are accessed in Auto Scan mode can be further filtered via the Filter section of the Port Access page. (See *Filter* section under *Connections* in *OSD Operation* for details.)

Setting the Scan Interval

The scan interval used during Auto Scan mode can be set in the User Settings menu. (See *User Preferences* section under *OSD Operation* for details.) The scan interval can be set from 1 to 255 seconds. The default is 5 seconds.

Invoking Auto Scan

Auto Scan Mode can be invoked when in the OSD or when in a remote session. When in the OSD, Auto Scan mode can be invoked by clicking on the Auto Scan button in the lower-left corner of the Port Access section. When in a remote session, Auto Scan Mode can be invoked by opening the OSD toolbar and tapping the A key. Once started, Auto Scan cycles through the ports in order, starting with the first accessible port on the installation. During Auto Scan Mode, an S appears in front of the Port ID Display to indicate that the port is being accessed under Auto Scan Mode.

Pausing Auto Scan

Auto Scan Mode can be paused in order to keep the focus on a particular computer by pressing P during an Auto Scan. When paused, the S that displays in front of the Port ID blinks On and Off. Pausing when you want to keep the focus on a particular computer can be more convenient than exiting Auto Scan Mode because when you resume scanning, you start from where you left off. If you were to exit and then restart Auto Scan Mode, the scanning would start over from the very first computer on the installation. To resume Auto Scan Mode after pausing, press any key except **[Esc]** or the **[Spacebar]**, which will exit Auto Scan Mode completely.

Exiting Auto Scan

While Auto Scan Mode is in effect, ordinary keyboard functions are suspended. You must exit Auto Scan Mode in order to regain normal control of the keyboard. To exit Auto Scan Mode press **[Esc]** or the **[Spacebar]**.

The Log Server

The Windows-based Log Server is an administrative utility that records all the events that take place on selected B064-Series KVM Switch units and writes them to a searchable database. This chapter describes how to install and configure the Log Server.

Installation

1. From the computer that you want to use as the Log Server, open your browser and log into the B064-Series KVM Switch.
2. Download the Log Server by clicking on the Download Icon at the top of the page and selecting it from the drop-down list.
3. Navigate to where you saved the Log Server file and double-click on it to open it. If any security warning dialog boxes appear, ignore them and click *Run* or *Open*. The Log Server installation screen appears:
4. Click *Next*. Then follow the on-screen instructions to complete the installation and have the Log Server program icon placed on your desktop.
5. Before starting up the Log Server, go to the Device Management section of the B064-Series KVM Switch OSD and open up the ANMS tab. In the corresponding fields, enter the MAC Address and Port Number for the computer/server that you have installed the Log Server on. (See *Advanced Network Management Settings* section under *Device Management in OSD Operation* for details)

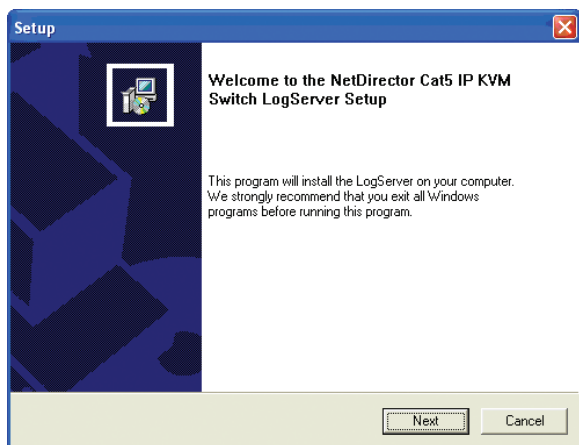

Starting Up

To bring up the Log Server, either double click the program icon, or key in the full path to the program on the command line. The first time you run it, a screen similar to the one below appears:

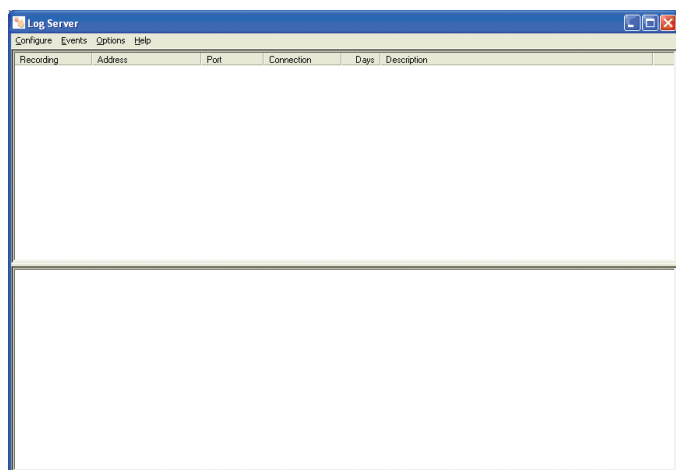

Note: The Log Server requires the Microsoft Jet OLEDB 4.0 driver in order to access the database.

The screen is divided into three components:

- A *Menu Bar* at the top
- A panel that will contain a list of all B064-Series KVM Switch units in the middle
- A panel that will contain an *Events List* at the bottom

The Log Server

The Menu Bar

The Menu bar consists of four drop-down menus:

- Configure
- Events
- Options
- Help

Note: If the Menu Bar appears to be disabled, select one of the B064-Series KVM Switch units from the list window to enable it.

Configure

The *Configure* menu consists of three functions: *Add*, *Edit* and *Delete*.

Add

Select the *Add* function when you need to add a new B064-Series KVM Switch to the list of units that the Log Server records events for.

Note: You must first add a B064-Series KVM Switch via the *Add* function before the Log Server can start recording its events.

When you open the *Add* function the following dialog box will appear:

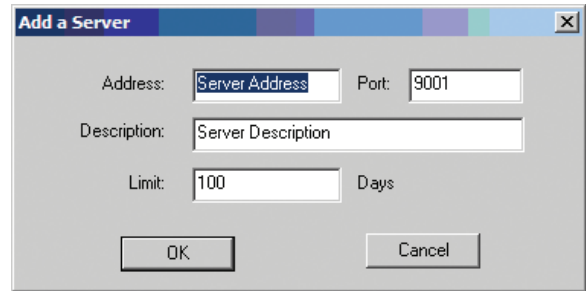

Descriptions of the fields in this dialog box are shown in the table below:

Field	Description
Address	This can either be the IP address of the B064-Series KVM Switch or its DNS name (if the network administrator has assigned it a DNS name). This value must be entered into the ANMS tab of the OSD Device Management Notebook to communicate with the Log Server. (See <i>Advanced Network Management Settings</i> section for details.)
Port	Key in the port number that was specified in the ANMS tab of the OSD Device Management Notebook. If the port number differs between the B064-Series KVM Switch OSD and the Log Server, the two will not be able to communicate with each other.
Description	This field is provided so that you can enter in additional information that will help differentiate this B064-Series KVM Switch from the rest of the devices the Log Server is recording information for.
Limit	This specifies the number of days that an event is kept in the Log Server's database before it can be deleted. To remove all events that have passed the expiration date set in this field, use the <i>Maintenance</i> function in the <i>Events</i> menu.

Edit

Select the *Edit* function to modify the information pertaining to an existing B064-Series KVM Switch. To edit an existing B064-Series KVM Switch, select it from the list and open the *Edit* function from the *Configure* drop-down menu. A dialog box will appear showing the exact information that was entered for the B064-Series KVM Switch when it was added using the *Add* function. Edit this information and click *OK*.

Delete

To delete a B064-Series KVM Switch, simply select it from the list and open the *Delete* function. A dialog box will appear which will display the B064-Series KVM Switch information and ask you to click *OK* to delete it. If you want to remove it from the Log Server, click *OK*.

The Log Server

Events

The Events Menu consists of two items: *Search* and *Maintenance*.

Search

Search allows you to search for events containing specific words or strings. When you access this function, a screen similar to the one below appears:

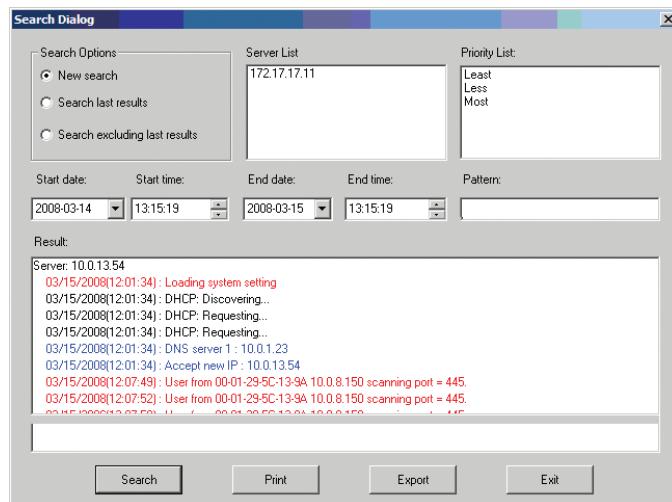

A description of the items from the *Search* screen is given in the table below:

Item	Description
Search Options	New search: When selected, the search is performed on all the events in the database for the selected B064-Series KVM Switch.
	Search last results: This is a secondary search performed on the events that resulted from the last search.
	Search excluding last results: This is a secondary search performed on all the events in the database for the selected B064-Series KVM Switch <i>excluding</i> the events that resulted from the last search.
Server List	B064-Series KVM Switch units are listed according to their IP address. Select the unit that you want to perform the search on from this list. You can select more than one unit for the search. If no units are selected, the search is performed on all of them.
Priority List	Sets the level for how detailed the search results display should be. If nothing is selected, all results will display. If all results do display, entries highlighted in Red are of high or <i>Most</i> important to installations security. Entries highlighted in Blue are of medium or <i>Less</i> important to installations security. Entries highlighted in Black are of the least or <i>Least</i> important to installations security.
Start Date	Select the date that you want the search to start from. The format follows the MM/DD/YYYY convention. (e.g. 11/15/2009)
Start Time	Select the time that you want the search to start from.
End Date	Select the date that you want the search to end at. The format follows the MM/DD/YYYY convention. (e.g. 11/15/2009)
End Time	Select the time that you want the search to end at.
Pattern	Key in text here that you want the search to filter the events by.
Results	The events that matched your search terms are listed here.
Search	After you have entered in all of your search terms, click this button to start the search.
Print	Click this button to print the search results.
Export	Click this button to export Log Server search results as a text file
Exit	Click this button to exit the Search dialog box.

Maintenance

This function allows the administrator to remove all records that have passed their expiration limit. (See *Configure* under *The Log Server* for limit details) In order to delete old files from the log server, the maintenance function must be performed.

The Log Server

Options

The *Options* menu consists of only one function: *Network Retry*.

Network Retry

Network Retry allows you to set the number of seconds that the Log Server should wait before attempting to connect if the previous connection attempt failed. When you click this item, a dialog box, similar to the one below appears:

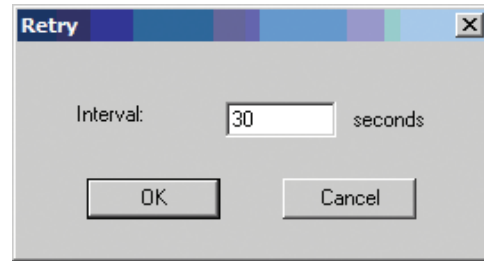

Key in the desired number of seconds and click *OK* to finish.

Help

The *Help* menu consists of two options; *Contents* and *About Log Server*.

Contents

Selecting the *Contents* function brings up an online Windows Help file. The Help file contains instructions on how to set up, operate and troubleshoot the Log Server.

About Log Server

Selecting the *About Log Server* option brings up a dialog box that displays the version number of the Log Server.

The Log Server Main Screen — Overview

The Log Server Main Screen is divided into two main panels: an upper (List) panel that displays all devices that have been added to the Log Server and a lower (Event) panel that displays the log events for the currently selected B064-Series KVM Switch. To select a B064-Series KVM Switch unit in the list, simply click on it.

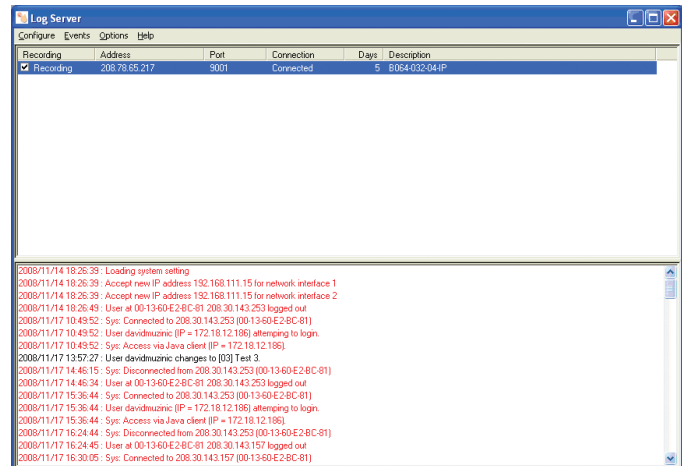

The Log Server

The Log Server Main Screen — Overview

The List Panel

The List panel contains the following fields:

Field	Description
Recording	Determines whether the Log Server records log events for the corresponding B064-Series KVM Switch. If the Recording check box is checked, the field displays <i>Recording</i> , and log events are recorded. If the Recording check box is not checked, the field displays <i>Paused</i> , and log events are not recorded. Note: <i>Even if a B064-Series KVM Switch is not currently selected, if its Recording check box is checked, the Log Server will still record its log events.</i>
Address	This is the IP Address or DNS name that was given to the B064-Series KVM Switch when it was added to the Log Server.
Port	This is the port number that was assigned to the B064-Series KVM Switch when it was added to the Log Server.
Connection	If the Log Server is properly connected to the B064-Series KVM Switch, this field displays <i>Connected</i> . If it is not connected, this field displays <i>Waiting</i> . This means that the Log Server is not communicating with the B064-Series KVM Switch, and will not record its events. This occurs when the Log Server's MAC address and/or port number have not been set properly. The MAC Address and Port for the Log Server computer must be entered into the ANMS tab of the OSD Device Management Section. In addition, the B064-Series KVM Switch's IP Address and Port must be entered when adding it to the Log Server. If the Port numbers in the B064-Series KVM Switch and the Log Server do not match, they will not be able to communicate.
Days	This field displays the number of days that the B064-Series KVM Switch's log events are to be kept in the Log Server's database before it is eligible for deletion.
Description	This field displays the descriptive information given for the B064-Series KVM Switch when it was added to the Log Server.









The Event Panel

The lower panel displays event information for the currently selected B064-Series KVM Switch.

Keyboard Emulation

Mac Keyboard







The PC compatible (101/104 key) keyboard can emulate the functions of the Mac keyboard. The emulation mappings are listed in the table below.

PC Keyboard	Mac Keyboard
[Shift]	Shift
[Ctrl]	Ctrl
	
[Ctrl] [1]	
[Ctrl] [2]	
[Ctrl] [3]	
[Ctrl] [4]	
[Alt]	Alt
[Print Screen]	F13
[Scroll Lock]	F14
	=
[Enter]	Return
[Backspace]	Delete
[Insert]	Help
[Ctrl] 	F15

Note: When using key combinations, press and release the first key (Ctrl), then press and release the activation key.

Sun Keyboard

The PC compatible (101/104 key) keyboard can emulate the functions of the Sun keyboard when the Control key [Ctrl] is used in conjunction with other keys. The corresponding functions are shown in the table below.

PC Keyboard	Sun Keyboard
[Ctrl] [T]	Stop
[Ctrl] [F2]	Again
[Ctrl] [F3]	Props
[Ctrl] [F4]	Undo
[Ctrl] [F5]	Front
[Ctrl] [F6]	Copy
[Ctrl] [F7]	Open
[Ctrl] [F8]	Paste
[Ctrl] [F9]	Find
[Ctrl] [F10]	Cut
[Ctrl] [1]	
[Ctrl] [2]	
[Ctrl] [3]	
[Ctrl] [4]	
[Ctrl] [H]	Help
	Compose
	

Note: When using key combinations, press and release the first key (Ctrl), then press and release the activation key.

General Operation Troubleshooting

Problem	Action
Erratic Operation.	<p>If a KVM switch is cascaded from it, the upper-level KVM must always be powered on before the lower-level KVM. If the cascaded switch was turned on first, resetting it may resolve the issue. If not, power off the installation and power everything on according to the installation instructions in this manual.</p> <ul style="list-style-type: none"> Reset the unit by pressing and holding the Reset button on the front of the unit for longer than three seconds.
I can't access the B064-Series KVM Switch, even though I have specified the IP address and port number correctly.	<p>If the B064-Series KVM Switch is behind a router, the router's Port Forwarding (also referred to as Virtual Server) feature must be configured.</p>
Mouse and/or Keyboard not responding.	<ul style="list-style-type: none"> If accessing the KVM via local console, unplug and replug the cable(s) from the console port(s). Turn the connected computer/server off and then back on. All connected devices need to be powered off when connecting to the KVM.
Sudden loss of network connection.	<p>Close your B064-Series KVM Switch connection. Wait approximately 30 seconds, and log in again.</p>
No video display on the remote console.	<ul style="list-style-type: none"> Make sure the resolution of the monitor being used to display the remote computer/server is higher than that of the remote computer/server. Make sure the OSD toolbar is closed. Sometimes mouse movement is required to bring the screen out of sleep mode. If the OSD toolbar is open, your mouse input is not being received by the remote computer/server. Check the firmware version number of the Server Interface Unit (SIU) you have connected to make sure it is the most current. (See <i>Upgrade Main Firmware</i> section under <i>Maintenance in OSD Operation</i> for details.) If not, upgrade the SIUs firmware. Press and release the left [Alt] key, then press and release the right [Alt] key.
When logging in from a browser, the following message appears: 404 Object Not Found.	<p>If a login string has been set (see <i>Login String</i> section under <i>Device Management in OSD Operation</i> for details), make sure to include the forward slash and correct login string when you specify the B064-Series KVM Switch IP address.</p>
When I log in, the browser generates a CA Root certificate is not trusted, or a Certificate Error response.	<p>The certificate can be trusted; you can proceed.</p>
There are two mouse pointers after the remote system is accessed.	<p>The KVM automatically defaults to show both the local and remote mouse pointers. You can choose to display both mouse pointers at the same time or only the remote mouse pointer. (See <i>Mouse Pointer</i> section under <i>OSD Main Page in OSD Operation</i> for details.)</p>
The display on the remote console is distorted and performing an Autosync doesn't resolve the problem.	<ul style="list-style-type: none"> Switch ports to a port with a different resolution and then switch back. Lower the resolution and refresh rate for the computer/server connected to the port.
I have been given an account, but I am unable to login	<ul style="list-style-type: none"> Make sure that you have correctly entered your username and password. Make sure that your System Administrator has given you proper access to the KVM switch.
The Lock LEDs on the Control Panel do not accurately portray my Lock status	<p>Click the LEDs on the <i>Control Panel</i> until they match those on your keyboard. Once matched up, changing a Lock LED on the keyboard will also change it in the <i>Control Panel</i> and vice versa.</p>
When I open a viewer, the web page does not display properly, and I receive an error message that says "Problems with this Web page might prevent it from being displayed properly...."	<ul style="list-style-type: none"> By default, IE6 and some versions of IE5 use the High security level for the Restricted Sites zone. Windows Server 2003 uses High security for both the Restricted Sites and Internet zones. You may need to enable Active Scripting, ActiveX Controls and Java Applets. To do this, follow these steps: 1) In Internet Explorer, open the Tools menu and select Internet Options. 2) In the Internet Options dialog box, click Security. 3) Click Default level, and click OK when prompted. Verify that Active Scripting, ActiveX Controls and Java Applets are not blocked. If some client computers work and others don't, verify the Internet Explorer or another program (e.g. Anti-Virus, Firewall, etc.) on your client computer are not configured to block Scripts, ActiveX Controls or Java Applets. Verify that your anti-virus program is not set to scan the Temporary Internet Files or Downloaded Program Files folders. Delete all temporary internet related files by following these steps: 1) Open the Tools menu in Internet Explorer and select Internet Options 2) Click on the General tab 3) Under Temporary Internet Files, click Settings 4) Click Delete Files and click OK when prompted 5) Click Delete Cookies and click OK when prompted 6) Under History, click on Clear History, Yes and click OK when prompted. Make sure that you have the latest version of Microsoft DirectX installed. Make sure that you have the latest version of Java installed.

Appendix

Administration Troubleshooting

Problem	Action
After upgrading the firmware and logging back in, the B064-Series KVM Switch appears to still be using the old firmware version.	Clear your browser's cache. Delete all temporary internet files and cookies. Close the browser and reopen it to log in with a new session.

Mouse Troubleshooting

Problem	Action
My mouse and/or keyboard is not responding.	<ul style="list-style-type: none">• Check the firmware version number of the Server Interface Unit (SIU) you have connected to make sure it is the most current. (See <i>Upgrade Main Firmware</i> section under <i>Maintenance</i> in <i>OSD Operation</i> for details.) If not, upgrade the SIUs firmware.• Turn off the computer/server you are having trouble with. Unplug and re-plug the SIU from the computer/server. Turn the computer/server back on.
Mouse movement is extremely slow.	<p>There is too much data going through your connection.</p> <ul style="list-style-type: none">• If the remote computer's wallpaper has a lot of graphics, switch it to a plain wallpaper.• Adjust your video settings to reduce the amount of data per the instructions in the <i>Video Settings</i> section under <i>OSD Main Page</i>.
There are two mouse pointers on my screen, how do I change this?	You can choose between 3 different pointer types. See <i>Mouse Pointer</i> section under <i>OSD Main Page</i>
My mouse pointers don't sync.	See <i>Mouse Pointer</i> section under <i>OSD Main Page</i> .

Virtual Media Troubleshooting

Problem	Action
Virtual Media works on all of my computers except one.	The remote server's mainboard may not support USB. Check to see if there is a new firmware and BIOS version for the mainboard that does support USB.
There is no <i>Virtual Media</i> icon on my control panel.	<ul style="list-style-type: none">• Virtual Media is only accessible on computers/servers that are connected to the KVM switch using a B055-001-USB-V2• Make sure that your System Administrator has given you access to the <i>Virtual Media</i> functionality.
I can't boot my remote server from my Virtual Media drive.	Your remote server's BIOS may not support booting from a USB drive. Check to see if there is a new firmware and BIOS version for the mainboard that does support USB.
If I connect a USB floppy drive to a remote server, it can boot the remote server; however, if I map it to the remote server as a Virtual Media drive, it cannot boot the remote server.	USB floppy drives have two types of format: UFI and CBI. Both can be used for OS level Virtual Media functions, but only UFI is currently supported for BIOS level, which includes boot functions.
I cannot mount a Folder as a Virtual Media device.	If the folder is formatted with the FAT16 file system, it must be less than 2Gb to be mounted.

Appendix

AP Windows Client Troubleshooting

Problem	Action
Windows Client won't connect to the B064-Series KVM Switch.	DirectX 8.0 or higher must be installed on your computer.
Remote mouse pointer is out of sync.	<ul style="list-style-type: none"> Perform a Video Auto Sync. (See <i>Video Settings</i> section under <i>OSD Main Page</i> in <i>OSD Operation</i> for details.) This will usually sync the local and remote mouse pointers. Use the Adjust Mouse Hotkey command. (See <i>Hotkeys</i> section under <i>OSD Main Page</i> in <i>OSD Operation</i> for details.) If this does not work, see <i>Mouse Pointer</i> section under <i>OSD Main Page</i>.
Part of remote window is off my monitor.	<ul style="list-style-type: none"> If Keep Screen Size is not enabled (see <i>Screen Mode</i> section under <i>OSD Main Page</i> in <i>OSD Operation</i> for details), try performing a Video Auto Sync (see <i>Video Settings</i> section under <i>OSD Main Page</i> in <i>OSD Operation</i>) to sync the local and remote monitors. If this does not work, you may have to manually adjust the Screen Position in the Video Settings screen. If Keep Screen Size is enabled, areas that are off the screen can be accessed by positioning the mouse pointer on the far side of the area you want to scroll to.
The remote screen is rotated 90 degrees.	Enable Keep Screen Size. (See <i>Control Panel</i> section under <i>OSD Main Page</i> in <i>OSD Operation</i> .)
I cannot run Net Meeting when the Windows Client is running.	Enable Keep Screen Size. (See <i>Control Panel</i> section under <i>OSD Main Page</i> in <i>OSD Operation</i> .)
My B064-Series KVM switch is not showing up in the device list when I open the AP Windows Client.	<ul style="list-style-type: none"> The port number entered into the <i>Program</i> field of your KVMs <i>Network</i> page (see <i>IP Installer</i> section under <i>NIC Settings</i> in <i>Super Administrator Setup</i> for details) must match the port number entered into the AP Windows Client's <i>Port</i> field. Only KVMs that match the port number entered into this field will show up in the device list. The <i>Enable Device List</i> option must be checked on the <i>Operating Mode</i> page for your KVM switch to show up in the Device List. (See <i>Working Mode</i> section under <i>Device Management</i> in <i>OSD Operation</i> for details.)
After upgrading the firmware to my KVM switch, the AP Windows Client no longer works.	The old version of your .ocx file was not deleted. Open <i>Explorer</i> and search for <i>WinClient.ocx</i> . Delete all occurrences.

WinClient ActiveX Viewer Troubleshooting

Problem	Action
The WinClient ActiveX Viewer will not connect to the KVM switch.	DirectX 8.0 or higher must be installed on your client computer.
After upgrading the firmware to my KVM switch, the WinClient ActiveX Viewer no longer works.	The old version of your .ocx file was not deleted. Open <i>Internet Explorer > Tools > Manage Add-ons</i> . Delete or disable all occurrences of <i>WinClient</i> .
Part of the remote window is off my monitor.	<ul style="list-style-type: none"> If Keep Screen Size is not enabled (see <i>Control Panel</i> section under <i>Remote Session Operation</i>), try performing a Video Auto Sync (see <i>Video Settings</i> section). If this does not work, you may have to manually adjust the video via the <i>Video Settings</i> page. If Keep Screen Size is enabled, areas that are off the screen can be accessed by positioning the mouse pointer on the far side of the area you want to scroll to.
The remote screen is rotated 90 degrees.	Enable the <i>Keep Screen Size</i> function. (See <i>Control Panel</i> section under <i>Remote Session Operation</i> for details.)
I cannot run Net Meeting when the WinClient is running.	Enable the <i>Keep Screen Size</i> function. (See <i>Control Panel</i> section under <i>Remote Session Operation</i> for details.)
After logging in, I can't open the WinClient ActiveX viewer.	<ul style="list-style-type: none"> You don't have the authority to install the <i>WinClient Control Add-on</i> on your client computer. Have your system administrator run the program for you the first time. Under Vista, you must also add the KVM switches URL to the list of trusted sites. Go to <i>Tools > Internet Options > Security > Trusted Sites > Sites</i>
When using Vista, I open the WinClient ActiveX Viewer and try to mount a driver or removable disk, but I am getting a message that says "Driver not ready."	This is due to Vista's User Account Control (UAC). If you are the computer's administrator, open your browser by right-clicking on it and selecting <i>Run as Administrator</i> . If you are not the administrator, you will need to have the administrator disable UAC.

Appendix

Panel Array Mode Troubleshooting

Problem	Action
The video resolution is of low quality.	This occasionally occurs when the screens are scaled down to fit into each panel. Decrease the number of panels that are displayed.
When multiple remote users are logged in, some of them only receive a partial image.	The first user to invoke Panel Array Mode should set it to display at least four panels.

Java Applet & AP Java Client Troubleshooting

For mouse synchronization problems, see *Manual Mouse Synchronization* section under *Control Panel* in *Remote Session Operation*. For connection and operation problems, see the table below:

Problem	Action
The AP Java Client won't connect to the B064-Series KVM Switch.	<ul style="list-style-type: none">• Java Runtime Environment 6, Update 3 or higher must be installed on your computer.• If a login string has been set, make sure to include the forward slash and correct string (see <i>Login String</i> section under <i>Device Management</i> in <i>OSD Operation</i> for details) when you specify the B064-Series KVM Switch's IP address.• Try closing the Java client and opening it again.
Pressing the Windows Menu key has no effect.	Java doesn't support the Windows Menu key.
Java Client performance deteriorates.	Exit the program and start again.
National language characters do not appear.	You must set the appropriate keyboard language in the Port Properties tab of the Port Access page. (See <i>Port Properties</i> section under <i>Connections</i> in <i>OSD Operation</i> for details.)
After upgrading the firmware of my KVM switch and logging into the OSD, my switch is still showing the old firmware version number.	You need to delete your Java temporary internet files. Open <i>Control Panel</i> > <i>Java</i> , and click on the <i>Settings</i> button in the <i>Temporary Internet Files</i> section. In the <i>Disk Space</i> section, click on <i>Delete Files</i> . When prompted, click <i>OK</i> .
When I try to add a folder to be mounted as a Virtual Media Drive, I am unable to select the folder. The only option I have is desktop.	In the folder selection entry field, enter the root directory of the folder you want to add. After that, the folders contained under the root directory will be displayed.

Log Server Troubleshooting

Problem	Action
The Log Server program does not run.	The Log Server requires the Microsoft Jet OLEDB 4.0 driver in order to access the database. This driver is automatically installed with Windows ME, 2000 and XP. For Windows 98 or NT, you will have to go to the Microsoft download site: http://www.microsoft.com/data/download.htm to retrieve the driver file: MDAC 2.7 RTM Refresh (2.70.9001.0). Since this driver is used in Windows Office Suite, an alternate method of obtaining it is to install Windows Office Suite. Once the driver file or Suite has been installed, the Log Server will run.

Sun Systems Troubleshooting

Problem	Action
Video display problems with HD15 interface systems (e.g. Sun Blade 1000 servers).*	<ul style="list-style-type: none"> • The display resolution should be set to 1024 x 768 @ 60Hz: Under Text Mode go to OK mode and issue the following commands: setenv output-device screen:r1024x768x60 reset-all Under XWindow: 1. Open a console and issue the following command: m64config -res 1024x768x60 2. Log out 3. Log in
Video display problems with 13W3 interface systems. (e.g. Sun Ultra servers)*	<ul style="list-style-type: none"> • The display resolution should be set to 1024 x 768 @ 60Hz: Under Text Mode go to OK mode and issue the following commands: setenv output-device screen:r1024x768x60 reset-all Under XWindow: 1. Open a console and issue the following command: ffbconfig -res 1024x768x60 2. Log out 3. Log in
The local and remote mouse pointers do not sync.	See <i>Manual Mouse Synchronization</i> section.

* These solutions work for most common Sun VGA cards. If using them fails to resolve the problem, consult the Sun VGA card's manual.

Specifications

	B064-008-01-IPG	B064-016-01-IPG
Port Selection Methods	Pushbutton, OSD and Hotkey	
Local Console Ports	HD18 Connector on back panel connects to included USB/PS2 Combo Console Cable Kit	
Computer/Server Ports	(x8) RJ45 F	(x16) RJ45 F
LAN Ports	(x2) RJ45 F	
Dial-In Modem Port	RJ45 F	
Multi-User Capability	1 Local, 1 Remote	1 Local, 1 Remote
Dual-Power Supplies	Yes	
Power Input Connector	(x2) IEC-320-C6	
I/P Rating	100-240V, 50/60Hz, 1A	
Single Power Supply Consumption	120V (15.8W) 230V (14.7W)	120V (18.0W) 230V (16.7W)
Dual Power Supply Consumption	120V (16.9W) 230V (17.1W)	120V (18.5W) 230V (18.1W)
On/Off Power Switch	Yes	
Additional USB Ports	(x3) USB A F	
Reset Button	Yes	
Port Selection Pushbuttons	2	
Keyboard/Mouse Emulation	USB (PC, Mac, Sun), PS/2, Serial	
Max Video Resolution	1600 x 1200 @ 60Hz	
Operating Temperature	32°F to 122°F (0°C to 50°C)	
Storage Temperature	-4°F to 140°F (-20°C to 60°C)	
Humidity	0 to 80%, RH, Noncondensing	
Dimensions (H x W x D)	1.75 x 17 x 10.75 in. / 4 x 43 x 27 cm	

Factory Default Settings

Setting	Default
Language	English
OSD Hotkey	[Scroll Lock], [Scroll Lock]
Port ID Display	Port Number + Name
Port ID Display Duration	3 Seconds
Scan/Skip Mode	All
Scan Duration	5 Seconds
Screen Blanker	0 minutes (Disabled)
Beeper	On
Viewer	Auto Detect
Welcome Message	Hide
Accessible Ports	Super Administrators – Full Access for all ports Administrators and Users – No Access for all ports

Specifications

Serial Adapter Pin Assignments

The table below shows the pin assignments for the RJ45 to DB9 Adapter (DTE to DCE) that comes with the unit.

Switch (RJ45)	Pins	Modem (DB9)
RTS	1	7
DTR	2	4
TXD	3	3
CTS	4	8
GND	5	5
RXD	6	2
DCD	7	1
DSR	8	6
		9 NC Not Used

Fan Location & Speed Information

The B064-Series KVM switch contains 6 fans, whose location is shown in the image below.

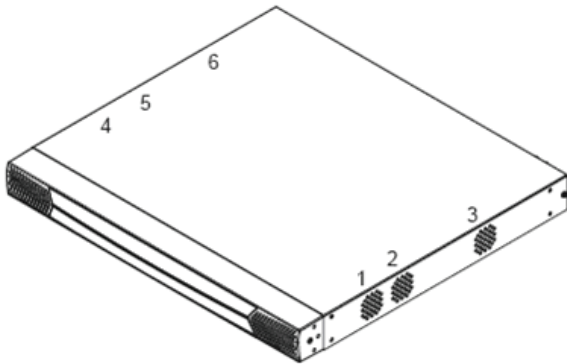

Fan Speed

Fan speed is automatically adjusted according to temperature. When the temperature reaches the levels mentioned below, the KVM switches temperature sensors adjust the fan speed accordingly.

- If any of the four sensors sense a temperature greater than 89°F (32°C), all of the fans will be set to spin at half speed
- When all four sensors sense the temperature is below 86°F (30°C), all of the fans will be turned off
- If any of the four sensors sense a temperature greater than 113°F (45°C), all of the fans will be set to spin at full speed
- When all four sensors sense the temperature is below 104°F (40°C), all of the fans will be set to spin at half speed

Temperature Sensor Location

The location of the KVM switches for temperature sensors is shown in the image below.

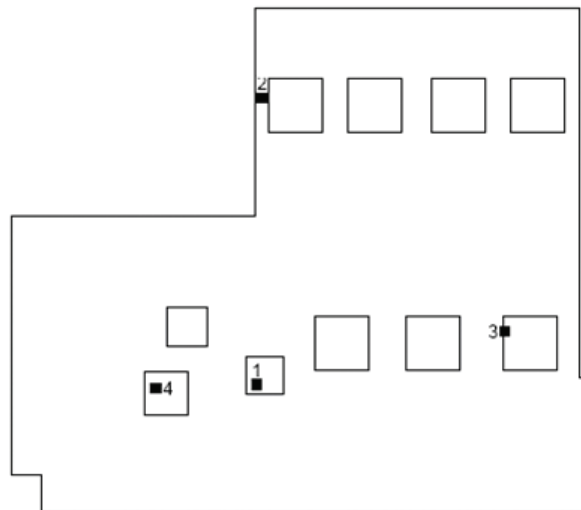

Note: The temperature inside the case can be higher than the ambient operating temperature of the KVM switch (32°F to 122°F / 0°C to 50°C). However, if the temperature reading shown in the Device Information section surpasses 185°F (85°C), you should either cool down the room or shut down the switch until it cools.

Warranty

3-YEAR LIMITED WARRANTY

We warrant our products to be free from defects in materials and workmanship for a period of three (3) years from the date of initial purchase. Our obligation under this warranty is limited to repairing or replacing (at its sole option) any such defective products. Visit Triplite.Eaton.com/support/product-returns before sending any equipment back for repair. This warranty does not apply to equipment which has been damaged by accident, negligence or misapplication or has been altered or modified in any way.

EXCEPT AS PROVIDED HEREIN, WE MAKE NO WARRANTIES, EXPRESS OR IMPLIED, INCLUDING WARRANTIES OF MERCHANTABILITY AND FITNESS FOR A PARTICULAR PURPOSE. Some states do not permit limitation or exclusion of implied warranties; therefore, the aforesaid limitation(s) or exclusion(s) may not apply to the purchaser.

EXCEPT AS PROVIDED ABOVE, IN NO EVENT WILL WE BE LIABLE FOR DIRECT, INDIRECT, SPECIAL, INCIDENTAL OR CONSEQUENTIAL DAMAGES ARISING OUT OF THE USE OF THIS PRODUCT, EVEN IF ADVISED OF THE POSSIBILITY OF SUCH DAMAGE. Specifically, we are not liable for any costs, such as lost profits or revenue, loss of equipment, loss of use of equipment, loss of software, loss of data, costs of substitutes, claims by third parties, or otherwise.

Regulatory Compliance Identification Numbers

For the purpose of regulatory compliance certifications and identification, your product has been assigned a unique series number. The series number can be found on the product nameplate label, along with all required approval markings and information. When requesting compliance information for this product, always refer to the series number. The series number should not be confused with the marking name or model number of the product.

FCC Notice, Class A

This device complies with part 15 of the FCC Rules. Operation is subject to the following two conditions: (1) This device may not cause harmful interference, and (2) this device must accept any interference received, including interference that may cause undesired operation.

Note: This equipment has been tested and found to comply with the limits for a Class A digital device, pursuant to part 15 of the FCC Rules. These limits are designed to provide reasonable protection against harmful interference when the equipment is operated in a commercial environment. This equipment generates, uses, and can radiate radio frequency energy and, if not installed and used in accordance with the instruction manual, may cause harmful interference to radio communications. Operation of this equipment in a residential area is likely to cause harmful interference in which case the user will be required to correct the interference at his own expense. The user must use shielded cables and connectors with this equipment. Any changes or modifications to this equipment not expressly approved by Eaton could void the user's authority to operate this equipment.

WEEE Compliance Information for Customers and Recyclers (European Union)



Under the Waste Electrical and Electronic Equipment (WEEE) Directive and implementing regulations, when customers buy new electrical and electronic equipment from Eaton they are entitled to:

- Send old equipment for recycling on a one-for-one, like-for-like basis (this varies depending on the country)
- Send the new equipment back for recycling when this ultimately becomes waste

Eaton has a policy of continuous improvement. Specifications are subject to change without notice. Photos and illustrations may differ slightly from actual products.



Powering Business Worldwide

Eaton
1000 Eaton Boulevard
Cleveland, OH 44122
United States
Eaton.com

© 2024 Eaton
All Rights Reserved
Publication No. 24-02-052 / 93-3595_revD
February 2024

Eaton is a registered trademark.

All trademarks are property
of their respective owners.